

Office Doctor Discount Office Furniture

www.OfficeDr.com 856-368-9085

Groupe Lacasse Half Price Sale On Now

Take Half Off the List Prices in this PDF

Call 856-368-9085 Now

Free Layout & Design Service

Metal Storage Cabinets & Files



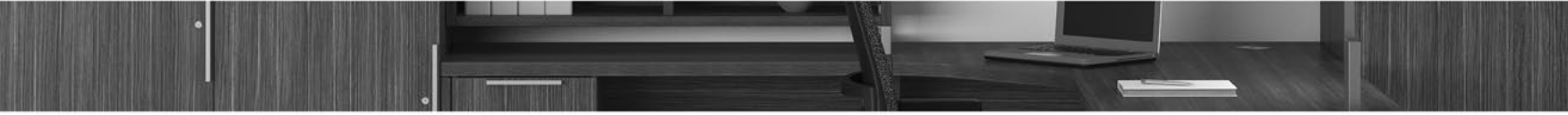

Metal Storage Furniture > Price Book > USA > February 2025



OFFICE
FURNITURE
SOLUTIONS

TABLE OF CONTENTS

AVAILABLE SPECIALS 2

QUICKSHIP PROGRAM 2

SPECIFICATIONS 3

 CHOOSING THE RIGHT STORAGE FURNITURE 3

 CAPACITY AND FILING SPACE 4

 COUNTERWEIGHTS AND ANCHORS 5

 LOCKING PROGRAM 5

 LATERAL FILES / CABINETS AND BOOKCASES 6

 WARDROBES / MULTIFUNCTION STORAGE FURNITURE 7

 VERTICAL FILES / COMBINED TOWERS / PEDESTALS 8

OPTION SPECIFICATIONS AND FINISHES 9

METAL STORAGE FURNITURE

LATERAL FILES 10

CABINETS 10-11

BOOKCASES 11

WARDROBES 11

MULTIFUNCTION STORAGE FURNITURE 11-12

VERTICAL FILES 12-13

LAMINATE TOPS 13

PEDESTALS 13-14

COMBINED TOWERS 14-15

ACCESSORIES 15-16

FIND OUT ABOUT OUR AVAILABLE SPECIALS!

Other special products are also available upon request: lockers, plan files, display cases, filing bookcases, etc. For information purposes, here are some examples of special products:

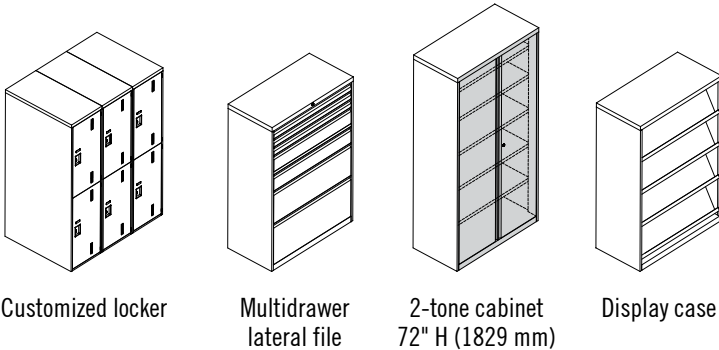

Customized locker

Multidrawer lateral file

2-tone cabinet
72" H (1829 mm)

Display case

CUSTOMIZED COLORS:

- It is possible to get a two-tone layout by specifying the front and case colors.
- It is also possible to develop a storage unit with your choice of color.

CUSTOMIZED DRAWERS DIMENSIONS AND CONFIGURATIONS:

- Standard-sized cases can easily accommodate your choice of drawer heights: 3" (76 mm), 6" (152 mm), 9" (229 mm), 12" (305 mm), 13 1/2" (343 mm) and 15" (381 mm).
- A storage unit can also be made with special dimensions (W x H x D).

IMPORTANT:

No minimum quantity necessary. However, certain conditions, dimensional limitations and development costs may apply. For any special request, please send your request to special@groupelacasse.com or contact Customer Service for further information.

LACASSE QUICKSHIP PROGRAM*

Products and suggested layouts identified by this pictogram are part of the Lacasse quick delivery program.

* Due to current market conditions, always refer to our Lead-Time Guide for a confirmation of our current Lacasse QuickShip lead-times.



PROGRAM CONDITIONS AND LIMITATIONS:

- Maximum of five (5) of each item and each color per order.
- QuickShip products are ready for shipment after reception of a ready-to-process order and delivered on next available trailer.

IMPORTANT:

Place QuickShip orders separately from regular Lacasse orders. When preparing QuickShip orders, indicate the code "QS" in front of the QuickShip product code; i.e.: QSRIDFS-183628LF2.

SPECIFICATIONS

CHOOSING THE RIGHT STORAGE FURNITURE

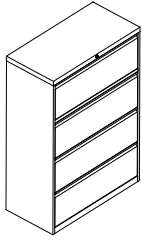

Lateral file with fixed fronts

Offers a superior filing capacity. Perfect for any workstation; allowing an easy access to files.

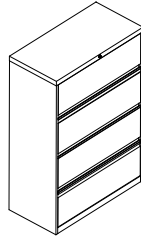

Lateral file with receding fronts and roll-out shelves

Designed for a quick consultation of documents with end-tabs. Perfect for the medical field.

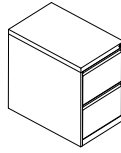

Pedestal / vertical file

Designed to be integrated into all your projects and requires little floor space. Vertical file is ideal for long-term filing.

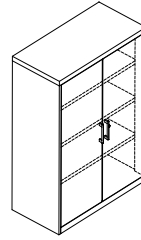

Cabinet / bookcase

Adjustable shelves allow an optimal use of storage space. Perfect for binders, books, catalogues and stationery.

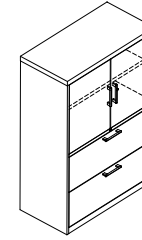

Multifunction storage unit / combined towers

The different compartments offer diversified storage space. Perfect for a small volume of filing and for an individual workstation.

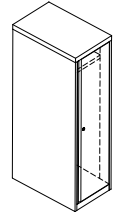

Wardrobe

Offers a safe personal storage space for clothes, shoes, bags, etc.

General Information

- In this price book, dimensions are exact and may differ from other Groupe Lacasse collections.
- Metal storage furniture is GREENGUARD GOLD certified and meets or exceeds ANSI/BIFMA standards. See product specifications for more details.
- Products are made from 68% recycled materials and are 99.5% recyclable.
- Furniture on glides is shipped assembled and ready to use.
- Cleaning method: clean furniture with a damp cloth and mild soap. Dry the surface with a soft cloth.

Design

- All products in this collection were carefully designed with horizontal lines that maintain a uniform appearance among the different storage units.
- Inset drawers and doors create a sleek and neutral look.

- The case construction with smooth seams and no overlaps allows to place the storage units side by side without creating unwanted gaps.
- The storage furniture gets its impeccable look from a smooth-finish powder paint.

General Specifications

- Each unit is equipped with 4 levelers that are accessible from the inside and allow an adjustment of 1" (25 mm), ensuring stability on uneven floors.
- The inside of storage units and drawers are the same color as the outside.
- Storage units with a height of 27 7/8" (708 mm) can support a work surface with a conventional height of 29" (737 mm) or more.
- Adding a laminate top on a unit that has a height of 27 7/8" (708 mm) or 40 1/16" (1018 mm) creates a work space at sitting or standing heights. See page 13.
- Classic (Z) and Straight (K) pulls are interchangeable; 5" (128 mm) on center drillings.

Steel Gauges



Storage furniture is entirely made and welded with first-quality cold-rolled steel. Please note that the lower the gauge, the thicker the steel.

	Lateral files / Multifunction files / Low storage units	Vertical files / Pedestal	Cabinets / Wardrobes	Bookcases	Cabinets-Lateral files combos	Combined towers
Top	20	20	20	20	20	20
Side	20	20	20	20	20	20
Back	20	20 / 14	20	20	20	20
Bottom	20	16	16	16	20	16
Drawer front	20	20	-	-	20	20
Drawer side	18	20	-	-	18	20
Drawer bottom	20	20	-	-	20	20
Top reinforcement	18	18	-	-	18	-
Side reinforcement	18	18	-	-	18	-
Crossbar	20*	20* / -	-	-	20	-
Leveler support	16	-	-	-	16	-
Flip system	20*	-	-	-	-	-
Door	-	-	20	-	20	20*
Shelf	-	-	20	20	20	20
Shelf support	-	-	18 / -	18	18	18

* If applicable.

SPECIFICATIONS

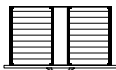
LATERAL FILES CAPACITY AND FILING SPACE

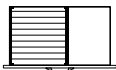
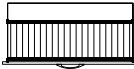
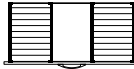
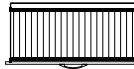
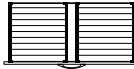
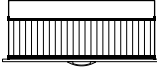
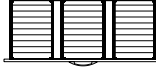
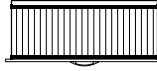
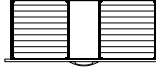
Fixed front				Filing Space - Letter Size		Espace de classement - Format légal	
Tiroirs	W x D x H (in)	W x D x H (mm)	Capacity	Left / Right	Front / Rear*	Left / Right	Front / Rear*
30" W (762 mm)	26 3/4 x 15 1/16 x 11 5/8	679 x 383 x 295	90 lb / 40,8 kg	 26 3/4" (679 mm)	 30 1/8" (765 mm)	 26 3/4" (679 mm)	 15 1/16" (383 mm)
36" W (914 mm)	32 3/4 x 15 1/16 x 11 5/8	832 x 383 x 295	105 lb / 47,6 kg	 32 3/4" (832 mm)	 30 1/8" (765 mm)	 32 3/4" (832 mm)	 30 1/8" (765 mm)
42" W (1067 mm)	38 3/4 x 15 1/16 x 11 5/8	984 x 383 x 295	125 lb / 56,7 kg	 38 3/4" (984 mm)	 45 3/16" (1148 mm)	 38 3/4" (984 mm)	 30 1/8" (765 mm)

* Requires front-to-back hanging bars, sold separately. See page 16.

Note: Fixed and roll-out shelves with retractable door have an interior filing height of 10 5/8" (270 mm) instead of 11 5/8" (295 mm).

CABINETS AND BOOKCASES CAPACITY AND FILING SPACE

Storage unit	Shelves Dimensions				Capacity (weight uniformly distributed)	
	Cabinet		Bookcase		Cabinet	Bookcase
	W x D x H (in)	W x D x H (mm)	W x D x H (in)	W x D x H (mm)		
30" W (762 mm)	29 3/4 x 14 1/4 x 3/4	756 x 362 x 19	29 3/4 x 16 3/4 x 3/4	756 x 425 x 19	90 lb / 40,8 kg	105 lb / 47,6 kg
36" W (914 mm)	35 3/4 x 14 1/4 x 3/4	908 x 362 x 19	35 3/4 x 16 3/4 x 3/4	908 x 425 x 19	105 lb / 47,6 kg	125 lb / 56,7 kg
42" W (1067 mm)	41 3/4 x 14 1/4 x 3/4	1060 x 362 x 19	41 3/4 x 16 3/4 x 3/4	1060 x 425 x 19	125 lb / 56,7 kg	145 lb / 65,8 kg

STORAGE SPACE AND CAPACITY OF VERTICAL FILES, TOWERS AND PEDESTALS

Storage unit	Interior Dimensions*				Capacity (weight uniformly distributed)	
	Box drawer		File drawer		Box drawer	File drawer
	W x D x H (in)	W x D x H (mm)	W x D x H (in)	W x D x H (mm)		
18" D (457 mm)	12 x 16 x 5 3/8	305 x 406 x 137	12 x 16 x 11 5/8	305 x 406 x 295	17 lb / 7,7 kg	36 lb / 16,3 kg
22" D (457 mm)	12 x 16 x 5 3/8	305 x 406 x 137	12 x 16 x 11 5/8	305 x 406 x 295	17 lb / 7,7 kg	36 lb / 16,3 kg
24" D (610 mm)	12 x 16 x 5 3/8	305 x 406 x 137	12 x 16 x 11 5/8	305 x 406 x 295	17 lb / 7,7 kg	36 lb / 16,3 kg
28" D Letter (711 mm)	12 x 24 x 5 3/8	305 x 610 x 137	12 x 24 x 11 5/8	305 x 610 x 295	26 lb / 11,8 kg	54 lb / 24,5 kg
28" D Legal (711 mm)	15 x 24 x 5 3/8	381 x 610 x 137	15 x 24 x 11 5/8	381 x 610 x 295	32 lb / 14,5 kg	67 lb / 30,4 kg

* Mobile pedestals: remove in height 1" (25 mm) per file drawer and 1/2" (13 mm) per box drawer.

COUNTERWEIGHTS AND ANCHORS

In order to meet ANSI/BIFMA standards of stability, some products must be installed under a work surface, be ganged/anchored or have a counterweight. Please see each product's Specifications section for more details.

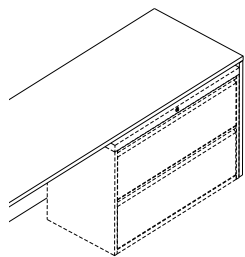

Installation under a work surface

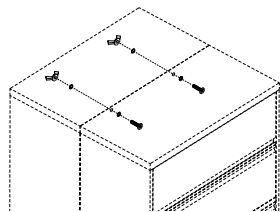

Back-to-back or side-by-side ganging*

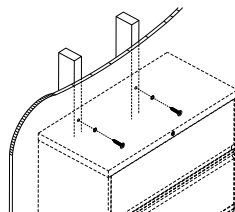

Wall anchoring

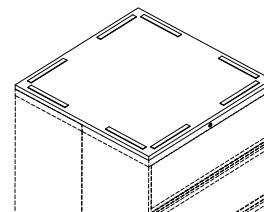

Ganging with a laminate top

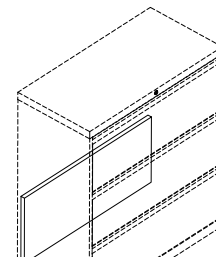

Factory-installed or optional counterweight**

* Ganging kit RINNN-GKIT sold separately, page 16.

** Refer to the price book for more details (see pages 15-16).

LOCKING PROGRAM

Standard Lock

- All storage units except bookcases are equipped with a single lock system. Cabinets/Lateral files combos have 2 locks.
- Each key lock has a factory-installed lock plug and key numbers are attributed in random fashion for each storage unit.
- It is possible to change lock plugs and install a keyed alike system. Master Key and Control Key also offered. For further information, contact the Groupe Lacasse Customer Service.
- The locking system accepts a key lock (standard) or an electronic lock (option).

Electronic Lock (option)

- The Versa Mini, from Numeris by Digilock, is an electronic lock intended to secure storage furniture for hospitality, retail and healthcare professionals.
- When specified in option, the electronic lock (D) is factory installed. A key lock on an existing unit can be changed for an electronic lock (see page 16).
- Installed horizontally with keypad on the left on a file and vertically installed with keypad at top on a cabinet or a wardrobe.

- The lock uses 2 small coin cell lithium batteries for an average of 50,000 actuations. The battery compartment is located within the front of the lock to allow changing batteries without unlocking or opening the door.
- The keypad interface allows the user to operate the lock with a 4 to 7-digit user code for a multitude of combinations.
- Manager Keys (required and sold separately, see page 16) provide bypass access in case the user is unable to access their storage unit. It can also operate the locks in case of battery failure. Manager Keys are programmed into the lock system by a unique Programming Key (required and sold separately, see page 16).
- The lock is programmed to assigned use functionality by default, which allows up to 20 simultaneous user codes. It can be easily changed to shared use functionality with a Programming Key.
- In shared use, the lock is designed for day use applications. The user chooses an available storage unit and operates it with a self-selected user credential code. Once the storage unit is vacated, it becomes available for a different user.
- Manager Keys are programmed into the lock system by a unique Programming Key (required and sold separately, see page 16).

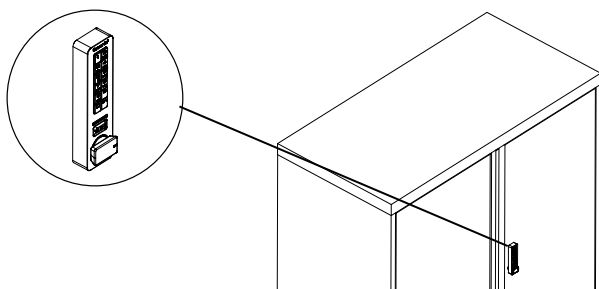

Vertical installation

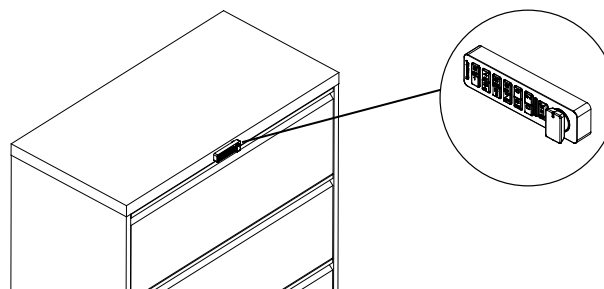

Horizontal installation

LATERAL FILES

- 15 different configurations are possible; 2, 3, 4, 5 or 6-high, 30" W (762 mm), 36" W (914 mm) or 42" W (1067 mm) and 18" D (457 mm).
- Drawers come with a fixed front (D) or a receding front and a roll-out shelf (R).
- A posting shelf (P) at a height of 40" (1016 mm) is available in option to make reading and filing easier. Offered on 4, 5 and 6-drawer files.
- On all configurations, the 1st drawer from the bottom has a fixed front (D). The 5th drawer has a receding front with a roll-out shelf (R). The 6th drawer has a receding front and a fixed shelf (F).

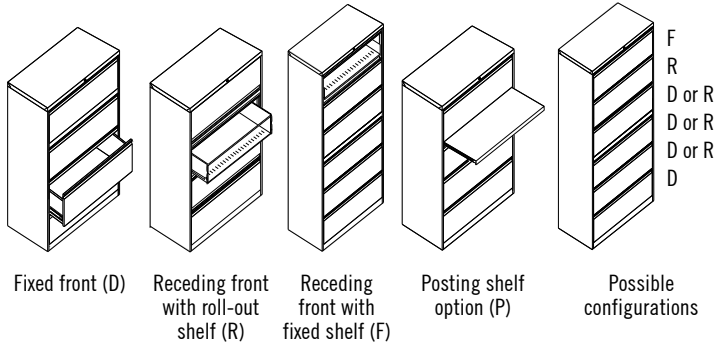

- Drawers are 12" H (305 mm) and can accommodate letter, legal or A4-size documents.
- In order to meet ANSI/BIFMA stability standards, lateral file must be installed under a work surface, be attached or have a counterweight (not required for 5 or 6-drawer files).
- A lock is installed above the highest drawer, allowing to lock all drawers at once.

- Drawers and roll-out shelves are equipped with full-extension telescopic slides. The ball-bearing system is designed to support intensive use.
- The 2-drawer file is also offered in universal height that fits under a 28" H (711 mm) work surface. That file doesn't offer the same visual compatibility when side-to-side with other units from this collection.
- Label holder included on each integrated pull for easy identification.
- Two hanging bars are included with each drawer to allow side-to-side filing. For front-to-back filing and dividers, see page 16.

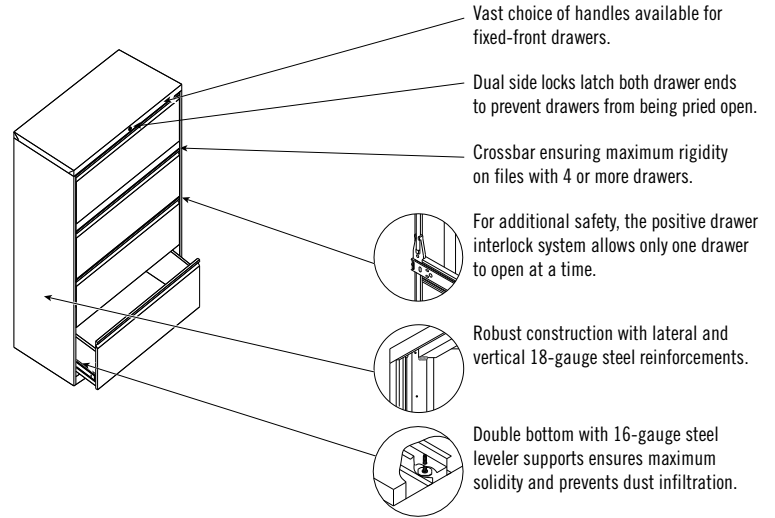

CABINETS AND BOOKCASES

- 15 different configurations are possible; 2, 3, 4, 5 or 6 compartments high, 30" W (762 mm), 36" W (914 mm) or 42" W (1067 mm) and 18" D (457 mm).
- A half-height lock is installed on the right door of the cabinet and allows to lock the 2 doors, from the bottom up.
- Interior space allows to store standard binders on all shelves except one (ex.: a 4-compartment cabinet or bookcase can hold binders on 3 shelves only).
- Shelves are adjustable every 1½" (38 mm). Additional shelves are available (see page 15).

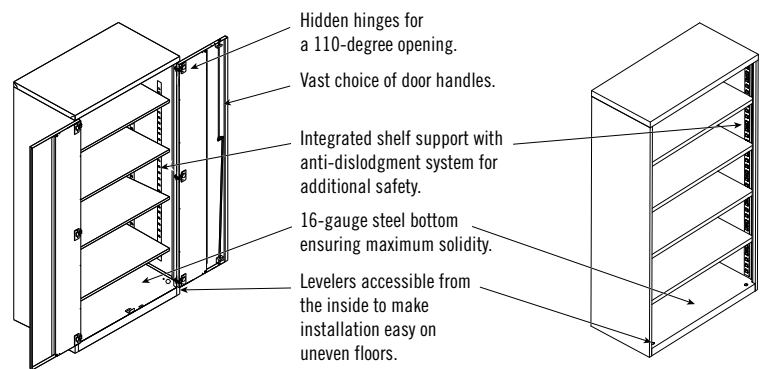

WARDROBES

- 8 different configurations are possible; hinges on left/right, 53 $\frac{3}{8}$ " H (1356 mm) and 65 $\frac{1}{2}$ " H (1664 mm), 15" W (381 mm) or 18" W (457 mm) and 24" D (610 mm).
- A half-height lock is installed on the door.
- A fixed shelf with a clothing hanger bar is located at 7 $\frac{1}{2}$ " H (191mm) from the top and allows the storage of personal effects.

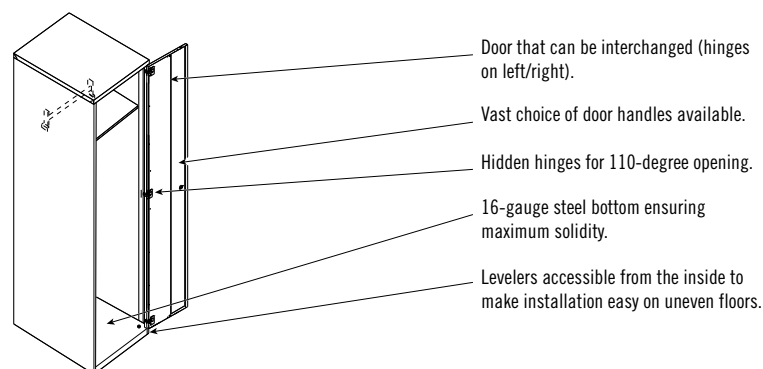

CABINETS / LATERAL FILES COMBOS

- 12 different configurations are possible; 2, 3, 4 or 5 compartments high, 30" W (762 mm), 36" W (914 mm) or 42" W (1067 mm) and 18" D (457 mm).
- In order to meet ANSI/BIFMA stability standards, 53 $\frac{3}{8}$ " H (1356 mm) or less cabinets/files must be attached or have a counterweight.
- Two independent locks for cabinet and drawers.
- Drawers are equipped with full-extension telescopic slides. The ball-bearing system is designed to support intensive use.
- Label holder included on each integrated pull for easy identification.
- Two hanging bars are included with each drawer to allow side-to-side filing. For front-to-back filing and dividers, see page 16.
- Shelves are adjustable every 1 $\frac{1}{2}$ " (38 mm). Additional shelves are available (see page 15).

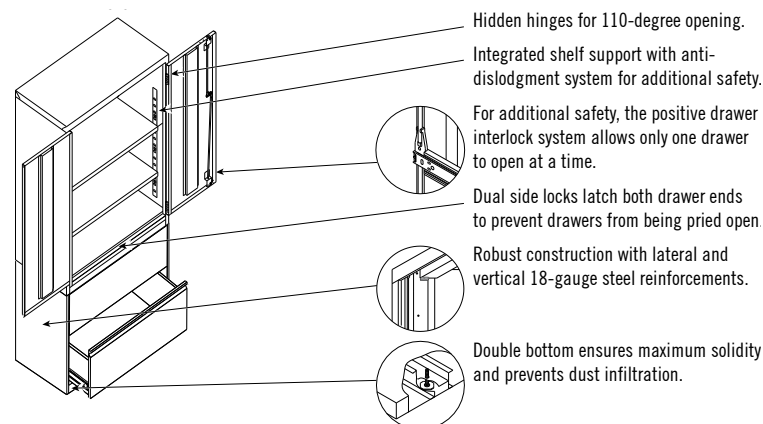

MULTIFUNCTION FILES

- 6 different configurations are possible; left or right box drawers, 30" W (762 mm), 36" W (914 mm) or 42" W (1067 mm) and 18" D (457 mm).
- In order to meet ANSI/BIFMA stability standards, multifunction files must be installed under a work surface, be attached or have a counterweight.
- Box drawers width is 12" (305 mm) for a 30" W (914 mm) unit, 18" (457 mm) for a 36" W (914 mm) unit, and 24" (610 mm) for a 42" W (1067 mm) unit.
- Central lock locks all drawers at once.
- Pencil tray included in the first box drawer.
- Label holder included on each integrated pull of lateral file drawer for easy identification.
- Two hanging bars are included with file drawers to allow side-to-side filing. For front-to-back filing and dividers, see page 16.
- Laminate tops and cushions are available. See pages 13 and 15.

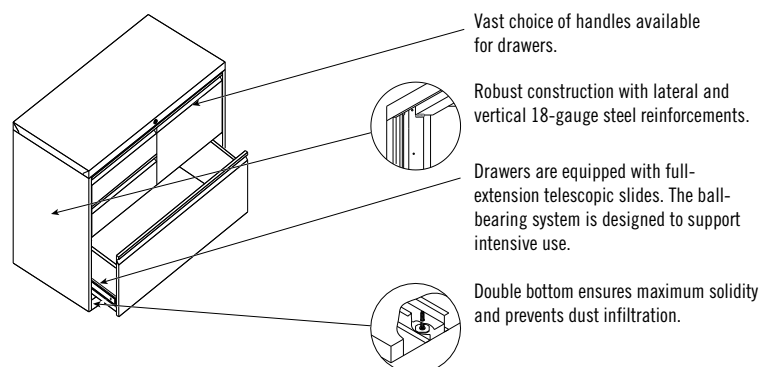

COMBINED TOWERS

- 32 different configurations are possible with a cabinet or bookcase combined with box and file drawers, with or without a wardrobe; 53 ³/₈" (1356 mm) and 65 ¹/₂" (1664 mm) in height, with a width of 14 ³/₄" (375 mm) or 23 ³/₄" (604 mm).
- The wardrobe, cabinet and pedestal each have their own lock, making it possible to lock each compartment independently.
- The drawers are equipped with full-extension telescopic slides. The ball bearing system is designed to support intensive use.
- Combined towers with a height of 53 ³/₈" (1356 mm) include 1 shelf, adjustable each 1 ¹/₂" (38 mm). Combined towers with a height of 65 ¹/₂" (1664 mm) include 2 shelves.
- Wardrobe and cabinet open outward. Cabinet hinges are interchangeable. Wardrobe has a clothing hanger bar.
- Pencil tray included in the first box drawer, and two hanging bars to allow side-to-side filing are included in each file drawer.
- Label holder included on each integrated file drawer pull for easy identification.

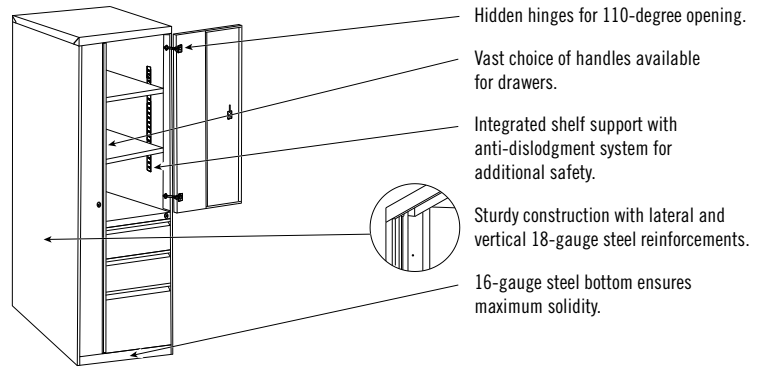

VERTICAL FILES

- 8 different configurations are possible; 2, 3, 4 or 5-high, 14 ³/₄" W (375 mm) or 17 ³/₄" W (451 mm) and 28" D (711 mm).
- In order to meet ANSI/BIFMA stability standards, vertical files with 3 or less drawers must be attached or have a counterweight.
- Drawers are 12" H (305 mm) and can accommodate letter, legal or A4-size documents. They are available with fixed front (D).
- A lock is installed above the highest drawer, allowing to lock all drawers at once.
- Label holder included on each integrated pull for easy identification.
- Full-height sides of drawers allow front-rear filing. For dividers and compressors, see page 16.

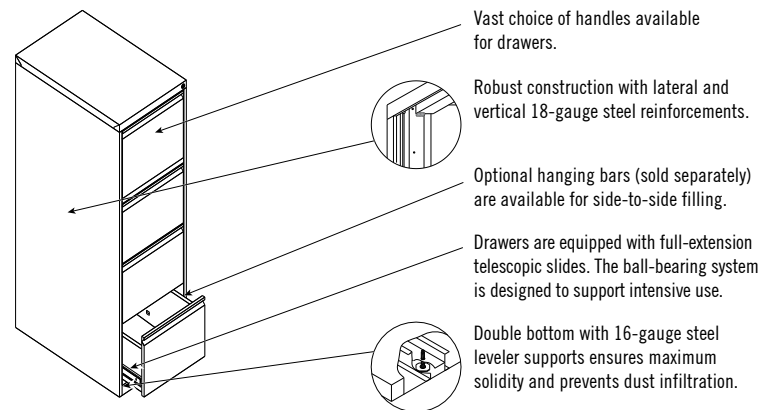

PEDESTALS

- 15 different configurations are possible: 3 drawer configurations with a depth of 18" (457 mm), 22" (559 mm) and 28" (711 mm). Offered on glides or casters.
- The pedestals meet ANSI/BIFMA stability standards and include a counterweight when necessary.
- The fixed pedestal has a box drawer with a height of 6" (152 mm) and a file drawer with a height of 12" (305 mm).
- The mobile pedestal has a box drawer with a height of 5 ¹/₂" (140 mm) and a file drawer with a height of 11" (279 mm).
- A single lock locks all drawers simultaneously.
- Pencil tray included in the first box drawer, and two hanging bars to allow side-to-side filing are included in each file drawer.
- Label holder included on each integrated file drawer pull for easy identification.
- For dividers and compressors, see page 16.
- The mobile pedestal can receive a cushion (RINNN-CU _ _ _ _).

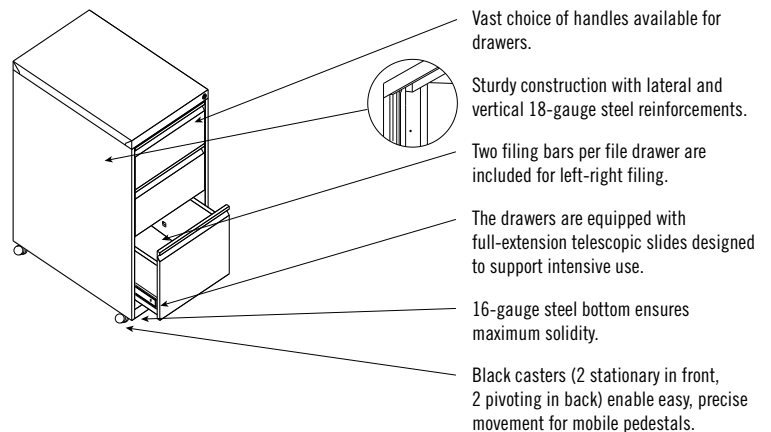

METAL STORAGE FURNITURE

SPECIFICATIONS

INTEGRATED PULLS



F – Full

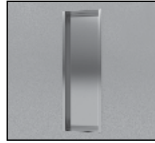

R – Recessed
Non-painted
aluminum

EXTERNAL PULLS

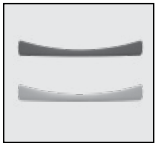

K – Classic

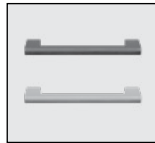

Z – Straight



M – Modern



W – Modern
White

ACCENT COLORS



A – Anthracite Grey



S – Silver

LOCKS



Standard



D – Electronic
Black or Nickel

LACASSE QUICKSHIP PROGRAM*

Products and suggested layouts identified by this pictogram are part of the Lacasse quick delivery program.

Please refer to page 2 for complete program details.

* Due to current market conditions, always refer to our Lead-Time Guide for a confirmation of our current Lacasse QuickShip lead-times.



CODIFICATION

Series	Options		
	Drawers	Pulls	Accent
RI	D Fixed front(s) R Recessed front(s)	F Full R Recessed Z Straight K Classic M Modern W White modern	A Anthracite Grey S Silver

OPTIONS INTEGRATION

Electronic lock: indicate **D** at the end of the code and add **\$675** to price.

Ex: **RIDFA-184254LF4D**

Counterweight: indicate **W** at the end of the code and add **\$281** to price. Factory installed.

Ex: **RIDFA-183028LF2W**

Posting shelf for lateral files with 4 or more drawers: indicate **P** at the end of the code and add **\$297** to price. Ex: **RIDFA-183054LF4P**

TOP - EDGEBANDING

N Edge

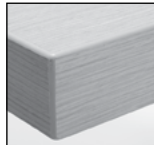

Smooth, $\frac{1}{16}$ " (1,5 mm) thick edge.

The **N** edge is matched with the finish specified for the surface.

CODIFICATION

Series	Options	
	Finishes / thickness	Edgebanding
R	1 Thermofused laminate top 1" 2 High-pressure laminate top 1" 5 Thermofused laminate top 1½" 6 High-pressure laminate top 1½"	N Smooth edge

METAL STORAGE FURNITURE - PAINT COLORS

Standard Colors

P01 Crystal Black
P04 Charcoal
P28 Anthracite Grey
P29 Willow Grey

P44 Metallic Silver
P53 Snow

CUSHIONS - CHOICE OF UPHOLSTERY

Several choices of upholstery are available. Please refer to the United Chair® Standard Upholstery Program.

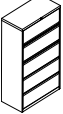
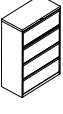
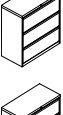
	W x D x H (in)	W x D x H (mm)	Code	Price (\$)
LATERAL FILES				
Fixed-front lateral files - integrated pulls	<i>The 5th drawer has a receding front with a roll-out shelf. The 6th drawer has a receding front with a fixed shelf. In order to comply with ANSI/BIFMA, a counterweight or anchoring solution is required for files with 4 or less drawers.</i>			
	6-high.			
	42 x 18 x 77 ⁵ / ₈	1067 x 457 x 1972	RID__-184278LF6	4,601
	36 x 18 x 77 ⁵ / ₈	914 x 457 x 1972	RID__-183678LF6	3,790
	30 x 18 x 77 ⁵ / ₈	762 x 457 x 1972	RID__-183078LF6	3,670
	Fixed fronts (D). Specify the pull code (F, R). Specify the accent color (A, S).			
	5-high.			
	42 x 18 x 65 ¹ / ₂	1067 x 457 x 1664	RID__-184266LF5	3,670
	36 x 18 x 65 ¹ / ₂	914 x 457 x 1664	RID__-183666LF5	2,851
	30 x 18 x 65 ¹ / ₂	762 x 457 x 1664	RID__-183066LF5	2,777
	Fixed fronts (D). Specify the pull code (F, R). Specify the accent color (A, S).			
	4-high.			
	42 x 18 x 53 ³ / ₈	1067 x 457 x 1356	RID__-184254LF4	2,842
	36 x 18 x 53 ³ / ₈	914 x 457 x 1356	RID__-183654LF4	2,311
	30 x 18 x 53 ³ / ₈	762 x 457 x 1356	RID__-183054LF4	2,297
	Fixed fronts (D). Specify the pull code (F, R). Specify the accent color (A, S).			
	3-high.			
	42 x 18 x 40 ¹ / ₁₆	1067 x 457 x 1018	RID__-184241LF3	2,256
	36 x 18 x 40 ¹ / ₁₆	914 x 457 x 1018	RID__-183641LF3	1,840
	30 x 18 x 40 ¹ / ₁₆	762 x 457 x 1018	RID__-183041LF3	1,783
	Fixed fronts (D). Specify the pull code (F, R). Specify the accent color (A, S).			
	2-high.			
	42 x 18 x 27 ¹ / ₈	1067 x 457 x 708	RID__-184228LF2	1,630
	36 x 18 x 27 ¹ / ₈	914 x 457 x 708	RID__-183628LF2	1,373
	30 x 18 x 27 ¹ / ₈	762 x 457 x 708	RID__-183028LF2	1,260
	Fixed fronts (D). Specify the pull code (F, R). Specify the accent color (A, S).			
	2-high, universal height.			
	42 x 18 x 26 ⁷ / ₈	1067 x 457 x 683	RID__-184227LF2	1,630
	36 x 18 x 26 ⁷ / ₈	914 x 457 x 683	RID__-183627LF2	1,373
	30 x 18 x 26 ⁷ / ₈	762 x 457 x 683	RID__-183027LF2	1,260
	Fixed fronts (D). Specify the pull code (F, R). Specify the accent color (A, S).			

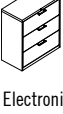



Fixed-front lateral files - external pulls	<i>In order to comply with ANSI/BIFMA, a counterweight or anchoring solution is required.</i>			
	4-high.			
	42 x 18 x 53 ³ / ₈	1067 x 457 x 1356	RID__-184254LF4	2,842
	36 x 18 x 53 ³ / ₈	914 x 457 x 1356	RID__-183654LF4	2,311
	30 x 18 x 53 ³ / ₈	762 x 457 x 1356	RID__-183054LF4	2,297
	Fixed fronts (D). Specify the pull code (K, M, Z, W). Specify the accent color (A, S).			
	3-high.			
	42 x 18 x 40 ¹ / ₁₆	1067 x 457 x 1018	RID__-184241LF3	2,256
	36 x 18 x 40 ¹ / ₁₆	914 x 457 x 1018	RID__-183641LF3	1,840
	30 x 18 x 40 ¹ / ₁₆	762 x 457 x 1018	RID__-183041LF3	1,783
	Fixed fronts (D). Specify the pull code (K, M, Z, W). Specify the accent color (A, S).			



Electronic lock option (D): add \$675.

Counterweight option (W): add \$281.

Posting shelf option (P)*: add \$297.

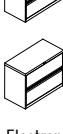
*Available on file with 4 drawers.

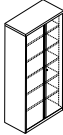
	W x D x H (in)	W x D x H (mm)	Code	Price (\$)
Fixed-front lateral files - external pulls (cont'd)				
	2-high.			
	42 x 18 x 27 ¹ / ₈	1067 x 457 x 708	RID__-184228LF2	1,630
	36 x 18 x 27 ¹ / ₈	914 x 457 x 708	RID__-183628LF2	1,373
	30 x 18 x 27 ¹ / ₈	762 x 457 x 708	RID__-183028LF2	1,260
	Fixed fronts (D). Specify the pull code (K, M, Z, W). Specify the accent color (A, S).			
	2-high, universal height.			
	42 x 18 x 26 ⁷ / ₈	1067 x 457 x 683	RID__-184227LF2	1,630
	36 x 18 x 26 ⁷ / ₈	914 x 457 x 683	RID__-183627LF2	1,373
	30 x 18 x 26 ⁷ / ₈	762 x 457 x 683	RID__-183027LF2	1,260
	Fixed fronts (D). Specify the pull code (K, M, Z, W). Specify the accent color (A, S).			
Receding-front lateral files - integrated pulls	<i>The 1st drawer from the bottom has a fixed front. The 6th drawer has a receding front with a fixed shelf. In order to comply with ANSI/BIFMA, a counterweight or anchoring solution is required for files with 4 or less drawers.</i>			
	6-high.			
	42 x 18 x 77 ⁵ / ₈	1067 x 457 x 1972	RIR__-184278LF6	4,954
	36 x 18 x 77 ⁵ / ₈	914 x 457 x 1972	RIR__-183678LF6	4,472
	30 x 18 x 77 ⁵ / ₈	762 x 457 x 1972	RIR__-183078LF6	4,439
	Receding fronts (R). Specify the pull code (F, R). Specify the accent color (A, S).			
	5-high.			
	42 x 18 x 65 ¹ / ₂	1067 x 457 x 1664	RIR__-184266LF5	4,103
	36 x 18 x 65 ¹ / ₂	914 x 457 x 1664	RIR__-183666LF5	3,533
	30 x 18 x 65 ¹ / ₂	762 x 457 x 1664	RIR__-183066LF5	3,469
	Receding fronts (R). Specify the pull code (F, R). Specify the accent color (A, S).			
	4-high.			
	42 x 18 x 53 ³ / ₈	1067 x 457 x 1356	RIR__-184254LF4	3,398
	36 x 18 x 53 ³ / ₈	914 x 457 x 1356	RIR__-183654LF4	2,940
	30 x 18 x 53 ³ / ₈	762 x 457 x 1356	RIR__-183054LF4	2,731
	Receding fronts (R). Specify the pull code (F, R). Specify the accent color (A, S).			
	3-high.			
	42 x 18 x 40 ¹ / ₁₆	1067 x 457 x 1018	RIR__-184241LF3	2,633
	36 x 18 x 40 ¹ / ₁₆	914 x 457 x 1018	RIR__-183641LF3	2,359
	30 x 18 x 40 ¹ / ₁₆	762 x 457 x 1018	RIR__-183041LF3	2,335
	Receding fronts (R). Specify the pull code (F, R). Specify the accent color (A, S).			
	2-high.			
	42 x 18 x 27 ¹ / ₈	1067 x 457 x 708	RIR__-184228LF2	2,247
	36 x 18 x 27 ¹ / ₈	914 x 457 x 708	RIR__-183628LF2	1,808
	30 x 18 x 27 ¹ / ₈	762 x 457 x 708	RIR__-183028LF2	1,679
	Receding front (R). Specify the pull code (F, R). Specify the accent color (A, S).			

	W x D x H (in)	W x D x H (mm)	Code	Price (\$)
CABINETS				
Cabinets - integrated pulls	<i>6 compartments (5 adjustable shelves).</i>			
	42 x 18 x 77 ⁵ / ₈	1067 x 457 x 1972	RIN__-421878B	2,756
	36 x 18 x 77 ⁵ / ₈	914 x 457 x 1972	RIN__-361878B	2,611
	30 x 18 x 77 ⁵ / ₈	762 x 457 x 1972	RIN__-301878B	2,458
	Specify the pull code (F, R). Specify the accent color (A, S).			
	<i>5 compartments (4 adjustable shelves).</i>			
	42 x 18 x 65 ¹ / ₂	1067 x 457 x 1664	RIN__-421866B	2,279
	36 x 18 x 65 ¹ / ₂	914 x 457 x 1664	RIN__-361866B	2,120
	30 x 18 x 65 ¹ / ₂	762 x 457 x 1664	RIN__-301866B	2,039
	Specify the pull code (F, R). Specify the accent color (A, S).			

Electronic lock option (D): add \$675.

Counterweight option (W): add \$281.

Posting shelf option (P)*: add \$297.

*Available on file with 4 and more drawers.

	W x D x H (in)	W x D x H (mm)	Code	Price (\$)
Cabinets - integrated pulls (cont'd)	<i>4 compartments (3 adjustable shelves).</i>			
	42 x 18 x 53 ³ / ₈	1067 x 457 x 1356	RIN__-421854B	1,982
	36 x 18 x 53 ³ / ₈	914 x 457 x 1356	RIN__-361854B	1,840
	30 x 18 x 53 ³ / ₈	762 x 457 x 1356	RIN__-301854B	1,766
	Specify the pull code (F, R). Specify the accent color (A, S).			
	<i>3 compartments (2 adjustable shelves).</i>			
	42 x 18 x 40 ¹ / ₁₆	1067 x 457 x 1018	RIN__-421841B	1,711
	36 x 18 x 40 ¹ / ₁₆	914 x 457 x 1018	RIN__-361841B	1,581
	30 x 18 x 40 ¹ / ₁₆	762 x 457 x 1018	RIN__-301841B	1,516
	Specify the pull code (F, R). Specify the accent color (A, S).			
	<i>2 compartments (1 adjustable shelf).</i>			
	42 x 18 x 27 ¹ / ₈	1067 x 457 x 708	RIN__-421828B	1,381
	36 x 18 x 27 ¹ / ₈	914 x 457 x 708	RIN__-361828B	1,301
	30 x 18 x 27 ¹ / ₈	762 x 457 x 708	RIN__-301828B	1,260
	Specify the pull code (F, R). Specify the accent color (A, S).			

Cabinets - external pulls	<i>6 compartments (5 adjustable shelves).</i>			
	42 x 18 x 77 ³ / ₈	1067 x 457 x 1972	RIN__-421878B	2,756
	36 x 18 x 77 ³ / ₈	914 x 457 x 1972	RIN__-361878B	2,611
	30 x 18 x 77 ³ / ₈	762 x 457 x 1972	RIN__-301878B	2,458
	Specify the pull code (K, M, Z, W). Specify the accent color (A, S).			
	<i>5 compartments (4 adjustable shelves).</i>			
	42 x 18 x 65 ¹ / ₂	1067 x 457 x 1664	RIN__-421866B	2,279
	36 x 18 x 65 ¹ / ₂	914 x 457 x 1664	RIN__-361866B	2,120
	30 x 18 x 65 ¹ / ₂	762 x 457 x 1664	RIN__-301866B	2,039
	Specify the pull code (K, M, Z, W). Specify the accent color (A, S).			
	<i>4 compartments (3 adjustable shelves).</i>			
	42 x 18 x 53 ³ / ₈	1067 x 457 x 1356	RIN__-421854B	1,982
	36 x 18 x 53 ³ / ₈	914 x 457 x 1356	RIN__-361854B	1,840
	30 x 18 x 53 ³ / ₈	762 x 457 x 1356	RIN__-301854B	1,766
	Specify the pull code (K, M, Z, W). Specify the accent color (A, S).			
	<i>3 compartments (2 adjustable shelves).</i>			
	42 x 18 x 40 ¹ / ₁₆	1067 x 457 x 1018	RIN__-421841B	1,711
	36 x 18 x 40 ¹ / ₁₆	914 x 457 x 1018	RIN__-361841B	1,581
	30 x 18 x 40 ¹ / ₁₆	762 x 457 x 1018	RIN__-301841B	1,516
	Specify the pull code (K, M, Z, W). Specify the accent color (A, S).			
	<i>2 compartments (1 adjustable shelf).</i>			
	42 x 18 x 27 ¹ / ₈	1067 x 457 x 708	RIN__-421828B	1,381
	36 x 18 x 27 ¹ / ₈	914 x 457 x 708	RIN__-361828B	1,301
	30 x 18 x 27 ¹ / ₈	762 x 457 x 708	RIN__-301828B	1,260
	Specify the pull code (K, M, Z, W). Specify the accent color (A, S).			

BOOKCASES

Bookcases	<i>6 compartments (5 adjustable shelves).</i>			
	42 x 18 x 77 ³ / ₈	1067 x 457 x 1972	RINNN-B427818	2,305
	36 x 18 x 77 ³ / ₈	914 x 457 x 1972	RINNN-B367818	2,135
	30 x 18 x 77 ³ / ₈	762 x 457 x 1972	RINNN-B307818	2,013
	<i>5 compartments (4 adjustable shelves).</i>			
	42 x 18 x 65 ¹ / ₂	1067 x 457 x 1664	RINNN-B426618	1,822
	36 x 18 x 65 ¹ / ₂	914 x 457 x 1664	RINNN-B366618	1,566
	30 x 18 x 65 ¹ / ₂	762 x 457 x 1664	RINNN-B306618	1,462
	<i>4 compartments (3 adjustable shelves).</i>			
	42 x 18 x 53 ³ / ₈	1067 x 457 x 1356	RINNN-B425418	1,453
	36 x 18 x 53 ³ / ₈	914 x 457 x 1356	RINNN-B365418	1,349
	30 x 18 x 53 ³ / ₈	762 x 457 x 1356	RINNN-B305418	1,252

	W x D x H (in)	W x D x H (mm)	Code	Price (\$)
Bookcases (cont'd)	<i>3 compartments (2 adjustable shelves).</i>			
	42 x 18 x 40 ¹ / ₁₆	1067 x 457 x 1018	RINNN-B424118	1,221
	36 x 18 x 40 ¹ / ₁₆	914 x 457 x 1018	RINNN-B364118	1,093
	30 x 18 x 40 ¹ / ₁₆	762 x 457 x 1018	RINNN-B304118	1,026
	<i>2 compartments (1 adjustable shelf).</i>			
	42 x 18 x 27 ¹ / ₈	1067 x 457 x 708	RINNN-B422818	1,045
	36 x 18 x 27 ¹ / ₈	914 x 457 x 708	RINNN-B362818	962
	30 x 18 x 27 ¹ / ₈	762 x 457 x 708	RINNN-B302818	924



WARDROBES

Wardrobes - integrated pulls	<i>18" (457 mm) wide.</i>			
	18 x 24 x 65 ¹ / ₂	457 x 610 x 1664	RIN__-241866B	1,912
	18 x 24 x 53 ³ / ₈	457 x 610 x 1356	RIN__-241854B	1,750
	Specify the pull code (F, R). Specify the accent color (A, S). Specify the door opening at the end of the code: hinges on left (L) or hinges on right (R).			
	<i>15" (381 mm) wide.</i>			
	15 x 24 x 65 ¹ / ₂	381 x 610 x 1664	RIN__-241566B	1,638
	15 x 24 x 53 ³ / ₈	381 x 610 x 1356	RIN__-241554B	1,556
	Specify the pull code (F, R). Specify the accent color (A, S). Specify the door opening at the end of the code: hinges on left (L) or hinges on right (R).			

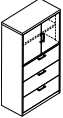
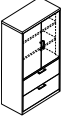
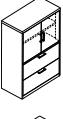

Wardrobes - external pulls	<i>18" (457 mm) wide.</i>			
	18 x 24 x 65 ¹ / ₂	457 x 610 x 1664	RIN__-241866B	1,912
	18 x 24 x 53 ³ / ₈	457 x 610 x 1356	RIN__-241854B	1,750
	Specify the pull code (K, M, Z, W). Specify the accent color (A, S). Specify the door opening at the end of the code: hinges on left (L) or hinges on right (R).			
	<i>15" (381 mm) wide.</i>			
	15 x 24 x 65 ¹ / ₂	381 x 610 x 1664	RIN__-241566B	1,638
	15 x 24 x 53 ³ / ₈	381 x 610 x 1356	RIN__-241554B	1,556
	Specify the pull code (K, M, Z, W). Specify the accent color (A, S). Specify the door opening at the end of the code: hinges on left (L) or hinges on right (R).			

MULTIFUNCTION STORAGE FURNITURE

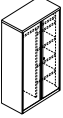

Cabinets / Lateral Files Combos - integrated pulls	<i>In order to comply with ANSI/BIFMA standards, a counterweight or anchoring solution is required on storage units 53³/₈" H (1356 mm) or less.</i>			
	<i>3 full width drawers, closed cabinet 23" H (584 mm) with 1 adjustable shelf.</i>			
	42 x 18 x 65 ¹ / ₂	1067 x 457 x 1664	RID__-184266LF3B	4,038
	36 x 18 x 65 ¹ / ₂	914 x 457 x 1664	RID__-183666LF3B	3,557
	30 x 18 x 65 ¹ / ₂	762 x 457 x 1664	RID__-183066LF3B	3,484
	Fixed fronts (D). Specify the pull code (F, R). Specify the accent color (A, S).			
	<i>2 full width drawers, closed cabinet 35" H (889 mm) with 2 adjustable shelves.</i>			
	42 x 18 x 65 ¹ / ₂	1067 x 457 x 1664	RID__-184266LF2B	3,782
	36 x 18 x 65 ¹ / ₂	914 x 457 x 1664	RID__-183666LF2B	3,372
	30 x 18 x 65 ¹ / ₂	762 x 457 x 1664	RID__-183066LF2B	3,213
	Fixed fronts (D). Specify the pull code (F, R). Specify the accent color (A, S).			
	<i>2 full width drawers, closed cabinet 23" H (584 mm) with 1 adjustable shelf.</i>			
	42 x 18 x 53 ³ / ₈	1067 x 457 x 1356	RID__-184254LF2B	3,420
	36 x 18 x 53 ³ / ₈	914 x 457 x 1356	RID__-183654LF2B	3,052
	30 x 18 x 53 ³ / ₈	762 x 457 x 1356	RID__-183054LF2B	2,979
	Fixed fronts (D). Specify the pull code (F, R). Specify the accent color (A, S).			
	<i>1 full width drawer, closed cabinet 23" H (584 mm) with 1 adjustable shelf.</i>			
	42 x 18 x 40 ¹ / ₁₆	1067 x 457 x 1018	RID__-184241LFB	3,261
	36 x 18 x 40 ¹ / ₁₆	914 x 457 x 1018	RID__-183641LFB	2,777
	30 x 18 x 40 ¹ / ₁₆	762 x 457 x 1018	RID__-183041LFB	2,706
	Fixed fronts (D). Specify the pull code (F, R). Specify the accent color (A, S).			

	W x D x H (in)	W x D x H (mm)	Code	Price (\$)
Cabinets / Lateral Files Combos - external pulls				
<i>In order to comply with ANSI/BIFMA standards, a counterweight or anchoring solution is required on storage units 53 3/8" H (1356 mm) or less.</i>				
<i>3 full width drawers, closed cabinet 23" H (584 mm) with 1 adjustable shelf.</i>				
	42 x 18 x 65 1/2	1067 x 457 x 1664	RID__-184266LF3B	4,038
	36 x 18 x 65 1/2	914 x 457 x 1664	RID__-183666LF3B	3,557
	30 x 18 x 65 1/2	762 x 457 x 1664	RID__-183066LF3B	3,484
Fixed fronts (D). Specify the pull code (K, M, Z, W). Specify the accent color (A, S).				
<i>2 full width drawers, closed cabinet 35" H (889 mm) with 2 adjustable shelves.</i>				
	42 x 18 x 65 1/2	1067 x 457 x 1664	RID__-184266LF2B	3,782
	36 x 18 x 65 1/2	914 x 457 x 1664	RID__-183666LF2B	3,372
	30 x 18 x 65 1/2	762 x 457 x 1664	RID__-183066LF2B	3,213
Fixed fronts (D). Specify the pull code (K, M, Z, W). Specify the accent color (A, S).				
<i>2 full width drawers, closed cabinet 23" H (584 mm) with 1 adjustable shelf.</i>				
	42 x 18 x 53 3/8	1067 x 457 x 1356	RID__-184254LF2B	3,420
	36 x 18 x 53 3/8	914 x 457 x 1356	RID__-183654LF2B	3,052
	30 x 18 x 53 3/8	762 x 457 x 1356	RID__-183054LF2B	2,979
Fixed fronts (D). Specify the pull code (K, M, Z, W). Specify the accent color (A, S).				
<i>1 full width drawer, closed cabinet 23" H (584 mm) with 1 adjustable shelf.</i>				
	42 x 18 x 40 7/16	1067 x 457 x 1018	RID__-184241LFB	3,261
	36 x 18 x 40 7/16	914 x 457 x 1018	RID__-183641LFB	2,777
	30 x 18 x 40 7/16	762 x 457 x 1018	RID__-183041LFB	2,722
Fixed fronts (D). Specify the pull code (K, M, Z, W). Specify the accent color (A, S).				

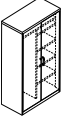

Counterweight option (W): add \$281.

Cabinets / Wardrobes Combos - integrated pulls				
<i>1 full width fixed shelf, 1 clothes hanger bar, 4 adjustable half shelves.</i>				
	42 x 18 x 77 3/8	1067 x 457 x 1972	RIN__-421878BC	3,261
	36 x 18 x 77 3/8	914 x 457 x 1972	RIN__-361878BC	3,076
	30 x 18 x 77 3/8	762 x 457 x 1972	RIN__-301878BC	3,001
Specify the pull code (F, R). Specify the accent color (A, S).				
<i>1 full width fixed shelf, 1 clothes hanger bar, 3 adjustable half shelves.</i>				
	42 x 18 x 65 1/2	1067 x 457 x 1664	RIN__-421866BC	3,165
	36 x 18 x 65 1/2	914 x 457 x 1664	RIN__-361866BC	3,001
	30 x 18 x 65 1/2	762 x 457 x 1664	RIN__-301866BC	2,954
Specify the pull code (F, R). Specify the accent color (A, S).				

Electronic lock option (D): add \$675.



Cabinets / Wardrobes Combos - external pulls				
<i>1 full width fixed shelf, 1 clothes hanger bar, 4 adjustable half shelves.</i>				
	42 x 18 x 77 3/8	1067 x 457 x 1972	RIN__-421878BC	3,261
	36 x 18 x 77 3/8	914 x 457 x 1972	RIN__-361878BC	3,076
	30 x 18 x 77 3/8	762 x 457 x 1972	RIN__-301878BC	3,001
Specify the pull code (K, M, Z, W). Specify the accent color (A, S).				
<i>1 full width fixed shelf, 1 clothes hanger bar, 3 adjustable half shelves.</i>				
	42 x 18 x 65 1/2	1067 x 457 x 1664	RIN__-421866BC	3,165
	36 x 18 x 65 1/2	914 x 457 x 1664	RIN__-361866BC	3,001
	30 x 18 x 65 1/2	762 x 457 x 1664	RIN__-301866BC	2,954
Specify the pull code (K, M, Z, W). Specify the accent color (A, S).				

Electronic lock option (D): add \$675.

Multifunction files - integrated pulls				
<i>In order to comply with ANSI/BIFMA standards, a counterweight or anchoring solution is required.</i>				
<i>1 full width file drawer, 1 file drawer on left, 2 box drawers on right.</i>				
	42 x 18 x 27 1/8	1067 x 457 x 708	RID__-C0184228	2,482
	36 x 18 x 27 1/8	914 x 457 x 708	RID__-C0183628	2,272
	30 x 18 x 27 1/8	762 x 457 x 708	RID__-C0183028	2,222
Fixed fronts (D). Specify the pull code (F, R). Specify the accent color (A, S).				
<i>1 full width file drawer, 1 file drawer on right, 2 box drawers on left.</i>				
	42 x 18 x 27 1/8	1067 x 457 x 708	RID__-184228CO	2,482
	36 x 18 x 27 1/8	914 x 457 x 708	RID__-183628CO	2,272
	30 x 18 x 27 1/8	762 x 457 x 708	RID__-183028CO	2,222
Fixed fronts (D). Specify the pull code (F, R). Specify the accent color (A, S).				



Electronic lock option (D): add \$675.

Counterweight option (W): add \$281.

	W x D x H (in)	W x D x H (mm)	Code	Price (\$)
Multifunction files - external pulls				
<i>In order to comply with ANSI/BIFMA standards, a counterweight or anchoring solution is required on storage units.</i>				
<i>1 full width file drawer, 1 file drawer on left, 2 box drawers on right.</i>				
	42 x 18 x 27 1/8	1067 x 457 x 708	RID__-C0184228	2,482
	36 x 18 x 27 1/8	914 x 457 x 708	RID__-C0183628	2,272
	30 x 18 x 27 1/8	762 x 457 x 708	RID__-C0183028	2,222
Fixed fronts (D). Specify the pull code (K, M, Z, W). Specify the accent color (A, S).				
<i>1 full width file drawer, 1 file drawer on right, 2 box drawers on left.</i>				
	42 x 18 x 27 1/8	1067 x 457 x 708	RID__-184228CO	2,482
	36 x 18 x 27 1/8	914 x 457 x 708	RID__-183628CO	2,272
	30 x 18 x 27 1/8	762 x 457 x 708	RID__-183028CO	2,222
Fixed fronts (D). Specify the pull code (K, M, Z, W). Specify the accent color (A, S).				

Electronic lock option (D): add \$675.



Counterweight option (W): add \$281.

Low storage units - integrated pulls				
<i>In order to comply with ANSI/BIFMA standards, a counterweight or anchoring solution is required on storage units with drawer(s).</i>				
<i>1 bookcase compartment, 1 pigeonhole.</i>				
	36 x 18 x 21 3/4	914 x 457 x 552	RINNN-BE361822	981
	30 x 18 x 21 3/4	762 x 457 x 552	RINNN-BE301822	900
Fixed fronts (D). Specify the pull code (F, R). Specify the accent color (A, S).				
<i>1 fixed-front file drawer, 1 pigeonhole.</i>				
	36 x 18 x 21 3/4	914 x 457 x 552	RID__-SLF361822	1,534
	30 x 18 x 21 3/4	762 x 457 x 552	RID__-SLF301822	1,478
Fixed front (D). Specify the pull code (F, R). Specify the accent color (A, S).				
<i>1 file drawer, 1 fixed-front utility drawer.</i>				
	36 x 18 x 21 3/4	914 x 457 x 552	RID__-UL361822	1,638
	30 x 18 x 21 3/4	762 x 457 x 552	RID__-UL301822	1,581
Fixed fronts (D). Specify the pull code (F, R). Specify the accent color (A, S).				

Electronic lock option (D)*: add \$675

Counterweight option (W)*: add \$281.



*Not available on low storage units with open compartments.

Low storage units - external pulls				
<i>In order to comply with ANSI/BIFMA standards, a counterweight or anchoring solution is required.</i>				
<i>1 fixed-front file drawer, 1 pigeonhole.</i>				
	36 x 18 x 21 3/4	914 x 457 x 552	RID__-SLF361822	1,534
	30 x 18 x 21 3/4	762 x 457 x 552	RID__-SLF301822	1,478
Fixed front (D). Specify the pull code (K, M, Z, W). Specify the accent color (A, S).				
<i>1 file drawer and 1 fixed-front utility drawer.</i>				
	36 x 18 x 21 3/4	914 x 457 x 552	RID__-UL361822	1,638
	30 x 18 x 21 3/4	762 x 457 x 552	RID__-UL301822	1,581
Fixed fronts (D). Specify the pull code (K, M, Z, W). Specify the accent color (A, S).				

Electronic lock option (D): add \$675.

Counterweight option (W): add \$281.

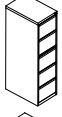
VERTICAL FILES

Vertical files - integrated pulls				
<i>In order to comply with ANSI/BIFMA standards, a counterweight or anchoring solution is required on files with 3 or less drawers.</i>				
<i>5-high.</i>				
	17 3/4 x 28 x 65 1/2	451 x 711 x 1664	RID__-281866VF5	2,506
	14 3/4 x 28 x 65 1/2	375 x 711 x 1664	RID__-281566VF5	2,506
Specify the pull code (F, R). Specify the accent color (A, S).				
<i>4-high.</i>				
	17 3/4 x 28 x 53 3/8	451 x 711 x 1356	RID__-281854VF4	2,007
	14 3/4 x 28 x 53 3/8	375 x 711 x 1356	RID__-281554VF4	2,007
Specify the pull code (F, R). Specify the accent color (A, S).				

	W x D x H (in)	W x D x H (mm)	Code	Price (\$)
Vertical files - integrated pulls (cont'd)	<i>3-high.</i>			
	17 ³ / ₄ x 28 x 40 ¹ / ₁₆	451 x 711 x 1018	RID__-281841VF3	1,758
	14 ³ / ₄ x 28 x 40 ¹ / ₁₆	375 x 711 x 1018	RID__-281541VF3	1,758
	Specify the pull code (F, R). Specify the accent color (A, S).			
	<i>2-high.</i>			
	17 ³ / ₄ x 28 x 27 ⁷ / ₈	451 x 711 x 708	RID__-281828VF2	1,260
	14 ³ / ₄ x 28 x 27 ⁷ / ₈	375 x 711 x 708	RID__-281528VF2	1,260
	Specify the pull code (F, R). Specify the accent color (A, S).			

Electronic lock option (D): add \$675.

Counterweight option (W): add \$281.

	<i>In order to comply with ANSI/BIFMA standards, a counterweight or anchoring solution is required on files with 3 or less drawers.</i>			
Vertical files - external pulls	<i>5-high.</i>			
	17 ³ / ₄ x 28 x 65 ¹ / ₂	451 x 711 x 1664	RID__-281866VF5	2,506
	14 ³ / ₄ x 28 x 65 ¹ / ₂	375 x 711 x 1664	RID__-281566VF5	2,506
	Specify the pull code (K, M, Z, W). Specify the accent color (A, S).			
	<i>4-high.</i>			
	17 ³ / ₄ x 28 x 53 ³ / ₈	451 x 711 x 1356	RID__-281854VF4	2,007
	14 ³ / ₄ x 28 x 53 ³ / ₈	375 x 711 x 1356	RID__-281554VF4	2,007
	Specify the pull code (K, M, Z, W). Specify the accent color (A, S).			
	<i>3-high.</i>			
	17 ³ / ₄ x 28 x 40 ¹ / ₁₆	451 x 711 x 1018	RID__-281841VF3	1,758
	14 ³ / ₄ x 28 x 40 ¹ / ₁₆	375 x 711 x 1018	RID__-281541VF3	1,758
	Specify the pull code (K, M, Z, W). Specify the accent color (A, S).			
	<i>2-high.</i>			
	17 ³ / ₄ x 28 x 27 ⁷ / ₈	451 x 711 x 708	RID__-281828VF2	1,260
	14 ³ / ₄ x 28 x 27 ⁷ / ₈	375 x 711 x 708	RID__-281528VF2	1,260
	Specify the pull code (K, M, Z, W). Specify the accent color (A, S).			

Electronic lock option (D): add \$675.

Counterweight option (W): add \$281.

LAMINATE TOPS

Double-faced tape included. When appropriately mounted, back-to-back tops (units with two or more drawers) or side-by-side tops (units with 3 or more drawers) are an efficient alternative to the use of counterweights.

Tops for individual storage unit	<i>Top 1" (25 mm) thick.</i>			
	42 ¹ / ₁₆ x 18 ¹ / ₁₆ x 1	1068 x 458 x 25	R_NNN-T04218	345 465
	36 ¹ / ₁₆ x 18 ¹ / ₁₆ x 1	916 x 458 x 25	R_NNN-T03618	329 426
	30 ¹ / ₁₆ x 18 ¹ / ₁₆ x 1	763 x 458 x 25	R_NNN-T03018	314 410
	Specify the finish (1, 2). Smooth edge (N).			
	<i>Top 1 1/2" (38 mm) thick.</i>			
	42 ¹ / ₁₆ x 18 ¹ / ₁₆ x 1 1/2	1068 x 458 x 38	R_NNN-T04218	465 594
	36 ¹ / ₁₆ x 18 ¹ / ₁₆ x 1 1/2	916 x 458 x 38	R_NNN-T03618	450 530
	30 ¹ / ₁₆ x 18 ¹ / ₁₆ x 1 1/2	763 x 458 x 38	R_NNN-T03018	433 498
	Specify the finish (5, 6). Smooth edge (N).			

Tops for 2 side-by-side storage units	<i>Top 1" (25 mm) thick.</i>			
	84 ¹ / ₈ x 18 ¹ / ₁₆ x 1	2136 x 458 x 25	R_NNN-T08418	465 643
	72 ¹ / ₈ x 18 ¹ / ₁₆ x 1	1832 x 458 x 25	R_NNN-T07218	426 594
	60 ¹ / ₈ x 18 ¹ / ₁₆ x 1	1526 x 458 x 25	R_NNN-T06018	394 545
	Specify the finish (1, 2). Smooth edge (N).			
	<i>Top 1 1/2" (38 mm) thick.</i>			
	84 ¹ / ₈ x 18 ¹ / ₁₆ x 1 1/2	2136 x 458 x 38	R_NNN-T08418	643 828
	72 ¹ / ₈ x 18 ¹ / ₁₆ x 1 1/2	1832 x 458 x 38	R_NNN-T07218	594 739
	60 ¹ / ₈ x 18 ¹ / ₁₆ x 1 1/2	1526 x 458 x 38	R_NNN-T06018	545 692
	Specify the finish (5, 6). Smooth edge (N).			

Tops for 2 back-to-back storage units.	<i>Top 1" (25 mm) thick.</i>			
	42 ¹ / ₁₆ x 36 ¹ / ₈ x 1	1068 x 916 x 25	R_NNN-T04236	426 618
	36 ¹ / ₁₆ x 36 ¹ / ₈ x 1	916 x 916 x 25	R_NNN-T03636	410 563
	30 ¹ / ₁₆ x 36 ¹ / ₈ x 1	763 x 916 x 25	R_NNN-T03036	378 498
	Specify the finish (1, 2). Smooth edge (N).			

	W x D x H (in)	W x D x H (mm)	Code	Dessus melamine (\$)	Dessus stratifié (\$)
Tops for 2 back-to-back storage units. (cont'd)	<i>Top 1 1/2" (38 mm) thick.</i>				
	42 ¹ / ₁₆ x 36 ¹ / ₈ x 1 1/2	1068 x 916 x 38	R_NNN-T04236	594	723
	36 ¹ / ₁₆ x 36 ¹ / ₈ x 1 1/2	916 x 916 x 38	R_NNN-T03636	578	650
	30 ¹ / ₁₆ x 36 ¹ / ₈ x 1 1/2	763 x 916 x 38	R_NNN-T03036	515	594
	Specify the finish (5, 6). Smooth edge (N).				
Tops for 4 back-to-back storage units	<i>Top 1" (25 mm) thick.</i>				
	84 ¹ / ₈ x 36 ¹ / ₈ x 1	2136 x 916 x 25	R_NNN-T08436	932	1,285
	72 ¹ / ₈ x 36 ¹ / ₈ x 1	1832 x 916 x 25	R_NNN-T07236	849	1,188
	60 ¹ / ₈ x 36 ¹ / ₈ x 1	1526 x 916 x 25	R_NNN-T06036	786	1,093
	Specify the finish (1, 2). Smooth edge (N).				
	<i>Top 1 1/2" (38 mm) thick.</i>				
	84 ¹ / ₈ x 36 ¹ / ₈ x 1 1/2	2136 x 916 x 38	R_NNN-T08436	1,285	1,655
	72 ¹ / ₈ x 36 ¹ / ₈ x 1 1/2	1832 x 916 x 38	R_NNN-T07236	1,188	1,478
	60 ¹ / ₈ x 36 ¹ / ₈ x 1 1/2	1526 x 916 x 38	R_NNN-T06036	1,093	1,381
	Specify the finish (5, 6). Smooth edge (N).				



Tops for individual storage unit - 24" D	<i>Top 1" (25 mm) thick.</i>			
	18 ¹ / ₁₆ x 24 ¹ / ₁₆ x 1	458 x 611 x 25	R_NNN-T01824	272 352
	15 ¹ / ₁₆ x 24 ¹ / ₁₆ x 1	382 x 611 x 25	R_NNN-T01524	260 329
	Specify the finish (1, 2). Smooth edge (N).			
	<i>Top 1 1/2" (38 mm) thick.</i>			
	18 ¹ / ₁₆ x 24 ¹ / ₁₆ x 1 1/2	458 x 611 x 38	R_NNN-T01824	378 450
	15 ¹ / ₁₆ x 24 ¹ / ₁₆ x 1 1/2	382 x 611 x 38	R_NNN-T01524	352 426
	Specify the finish (5, 6). Smooth edge (N).			



PEDESTALS

Fixed pedestals - integrated pulls	<i>Fixed pedestals may be affixed underneath a work surface (drilling required).</i>			
	<i>2 box drawers, 1 file drawer.</i>			
	14 ³ / ₄ x 28 x 27 ⁷ / ₈	375 x 711 x 708	RID__-P1528UF	905
	14 ³ / ₄ x 22 x 27 ⁷ / ₈	375 x 559 x 708	RID__-P1522UF	873
	14 ³ / ₄ x 18 x 27 ⁷ / ₈	375 x 457 x 708	RID__-P1518UF	886
	Specify the pull code (F, R). Specify the accent color (A, S).			
	<i>2 file drawers.</i>			
	14 ³ / ₄ x 28 x 27 ⁷ / ₈	375 x 711 x 708	RID__-P1528FF	841
	14 ³ / ₄ x 22 x 27 ⁷ / ₈	375 x 559 x 708	RID__-P1522FF	809
	14 ³ / ₄ x 18 x 27 ⁷ / ₈	375 x 457 x 708	RID__-P1518FF	827
	Specify the pull code (F, R). Specify the accent color (A, S).			

Fixed pedestals - external pulls	<i>Fixed pedestals may be affixed underneath a work surface (drilling required).</i>			
	<i>2 box drawers, 1 file drawer.</i>			
	14 ³ / ₄ x 28 x 27 ⁷ / ₈	375 x 711 x 708	RID__-P1528UF	905
	14 ³ / ₄ x 22 x 27 ⁷ / ₈	375 x 559 x 708	RID__-P1522UF	873
	14 ³ / ₄ x 18 x 27 ⁷ / ₈	375 x 457 x 708	RID__-P1518UF	886
	Specify the pull code (K, M, Z, W). Specify the accent color (A, S).			
	<i>2 file drawers.</i>			
	14 ³ / ₄ x 28 x 27 ⁷ / ₈	375 x 711 x 708	RID__-P1528FF	841
	14 ³ / ₄ x 22 x 27 ⁷ / ₈	375 x 559 x 708	RID__-P1522FF	809
	14 ³ / ₄ x 18 x 27 ⁷ / ₈	375 x 457 x 708	RID__-P1518FF	827
	Specify the pull code (K, M, Z, W). Specify the accent color (A, S).			

METAL STORAGE FURNITURE

	W x D x H (in)	W x D x H (mm)	Code	Price (\$)
Mobile pedestals - integrated pulls	<i>Black casters.</i>			
	<i>2 box drawers, 1 file drawer.</i>			
	14 ³ / ₄ x 28 x 26 ¹ / ₂	375 x 711 x 673	RID__-MP1528UF	986
	14 ³ / ₄ x 22 x 26 ¹ / ₂	375 x 559 x 673	RID__-MP1522UF	953
	14 ³ / ₄ x 18 x 26 ¹ / ₂	375 x 457 x 673	RID__-MP1518UF	971
	<i>Specify the pull code (F, R). Specify the accent color (A, S).</i>			
	<i>2 file drawers.</i>			
	14 ³ / ₄ x 28 x 26 ¹ / ₂	375 x 711 x 673	RID__-MP1528FF	924
	14 ³ / ₄ x 22 x 26 ¹ / ₂	375 x 559 x 673	RID__-MP1522FF	892
	14 ³ / ₄ x 18 x 26 ¹ / ₂	375 x 457 x 673	RID__-MP1518FF	911
		<i>Specify the pull code (F, R). Specify the accent color (A, S).</i>		
	<i>1 box drawer, 1 file drawer. Can accommodate a RINNN-CU15_____ cushion.</i>			
	14 ³ / ₄ x 28 x 20 ⁷ / ₈	375 x 711 x 530	RID__-MP1528F	858
	14 ³ / ₄ x 22 x 20 ⁷ / ₈	375 x 559 x 530	RID__-MP1522F	828
	14 ³ / ₄ x 18 x 20 ⁷ / ₈	375 x 457 x 530	RID__-MP1518F	844
		<i>Specify the pull code (F, R). Specify the accent color (A, S).</i>		





Mobile pedestals - external pulls	<i>Black casters.</i>			
	<i>2 box drawers, 1 file drawer.</i>			
	14 ³ / ₄ x 28 x 26 ¹ / ₂	375 x 711 x 673	RID__-MP1528UF	986
	14 ³ / ₄ x 22 x 26 ¹ / ₂	375 x 559 x 673	RID__-MP1522UF	953
	14 ³ / ₄ x 18 x 26 ¹ / ₂	375 x 457 x 673	RID__-MP1518UF	971
	<i>Specify the pull code (K, M, Z, W). Specify the accent color (A, S).</i>			
	<i>2 file drawers.</i>			
	14 ³ / ₄ x 28 x 26 ¹ / ₂	375 x 711 x 673	RID__-MP1528FF	924
	14 ³ / ₄ x 22 x 26 ¹ / ₂	375 x 559 x 673	RID__-MP1522FF	892
	14 ³ / ₄ x 18 x 26 ¹ / ₂	375 x 457 x 673	RID__-MP1518FF	911
		<i>Specify the pull code (K, M, Z, W). Specify the accent color (A, S).</i>		
	<i>1 box drawer, 1 file drawer. Can accommodate a RINNN-CU15_____ cushion.</i>			
	14 ³ / ₄ x 28 x 20 ⁷ / ₈	375 x 711 x 530	RID__-MP1528F	858
	14 ³ / ₄ x 22 x 20 ⁷ / ₈	375 x 559 x 530	RID__-MP1522F	828
	14 ³ / ₄ x 18 x 20 ⁷ / ₈	375 x 457 x 530	RID__-MP1518F	844
		<i>Specify the pull code (K, M, Z, W). Specify the accent color (A, S).</i>		



COMBINED TOWERS



65¹/₂" H (1664 mm): closed cabinet or bookcase 35" H (889 mm) with 2 adjustable shelves.
53³/₈" H (1356 mm): closed cabinet or bookcase 23" H (584 mm) with 1 adjustable shelf.







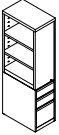
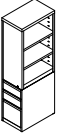

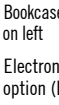
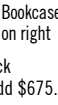
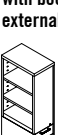
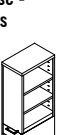
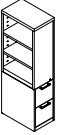
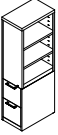
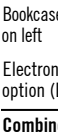
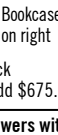
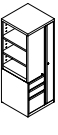
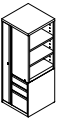
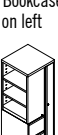
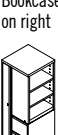

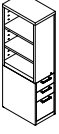
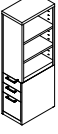
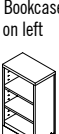
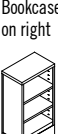
Combined towers with cabinet - integrated pulls	<i>1 cabinet, 2 box drawers, 1 file drawer.</i>			
	14 ³ / ₄ x 24 x 65 ¹ / ₂	375 x 610 x 1664	RID__-152466UFB_	1,971
	14 ³ / ₄ x 24 x 53 ³ / ₈	375 x 610 x 1356	RID__-152454UFB_	1,904
		<i>Specify the pull code (F, R). Specify the accent color (A, S). Specify the door opening at the end of the code: hinges on left (L) ou hinges on right (R).</i>		
	<i>1 cabinet, 2 file drawers.</i>			
	14 ³ / ₄ x 24 x 65 ¹ / ₂	375 x 610 x 1664	RID__-152466FFB_	1,945
	14 ³ / ₄ x 24 x 53 ³ / ₈	375 x 610 x 1356	RID__-152454FFB_	1,883
		<i>Specify the pull code (F, R). Specify the accent color (A, S). Specify the door opening at the end of the code: hinges on left (L) ou hinges on right (R).</i>		
	<i>1 cabinet, 2 file drawers.</i>			
	14 ³ / ₄ x 24 x 65 ¹ / ₂	375 x 610 x 1664	RID__-152466FFB_	1,945
14 ³ / ₄ x 24 x 53 ³ / ₈	375 x 610 x 1356	RID__-152454FFB_	1,883	
	<i>Specify the pull code (F, R). Specify the accent color (A, S). Specify the door opening at the end of the code: hinges on left (L) ou hinges on right (R).</i>			

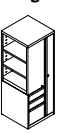
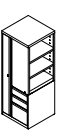
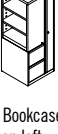





Combined towers with cabinet - external pulls	<i>1 cabinet, 2 box drawers, 1 file drawer.</i>			
	14 ³ / ₄ x 24 x 65 ¹ / ₂	375 x 610 x 1664	RID__-152466UFB_	1,971
	14 ³ / ₄ x 24 x 53 ³ / ₈	375 x 610 x 1356	RID__-152454UFB_	1,904
		<i>Specify the pull code (K, M, Z, W). Specify the accent color (A, S). Specify the door opening at the end of the code: hinges on left (L) ou hinges on right (R).</i>		
	<i>1 cabinet, 2 file drawers.</i>			
	14 ³ / ₄ x 24 x 65 ¹ / ₂	375 x 610 x 1664	RID__-152466FFB_	1,945
	14 ³ / ₄ x 24 x 53 ³ / ₈	375 x 610 x 1356	RID__-152454FFB_	1,883
		<i>Specify the pull code (K, M, Z, W). Specify the accent color (A, S). Specify the door opening at the end of the code: hinges on left (L) ou hinges on right (R).</i>		
	<i>1 cabinet, 2 file drawers.</i>			
	14 ³ / ₄ x 24 x 65 ¹ / ₂	375 x 610 x 1664	RID__-152466FFB_	1,945
14 ³ / ₄ x 24 x 53 ³ / ₈	375 x 610 x 1356	RID__-152454FFB_	1,883	
	<i>Specify the pull code (K, M, Z, W). Specify the accent color (A, S). Specify the door opening at the end of the code: hinges on left (L) ou hinges on right (R).</i>			



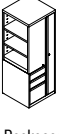

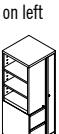
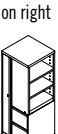





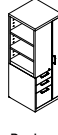
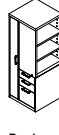
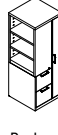
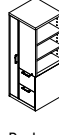

Combined towers with cabinet / wardrobe - integrated pulls	<i>1 cabinet on left, 2 box drawers, 1 file drawer, 1 wardrobe with clothes hanger bar on right.</i>			
	23 ³ / ₄ x 24 x 65 ¹ / ₂	603 x 610 x 1664	RID__-242466BUF	2,438
	23 ³ / ₄ x 24 x 53 ³ / ₈	603 x 610 x 1356	RID__-242454BUF	2,372
		<i>Specify the pull code (F, R). Specify the accent color (A, S).</i>		
	<i>1 cabinet on right, 2 box drawers, 1 file drawer, 1 wardrobe with clothes hanger bar on left.</i>			
	23 ³ / ₄ x 24 x 65 ¹ / ₂	603 x 610 x 1664	RID__-242466UFB	2,438
	23 ³ / ₄ x 24 x 53 ³ / ₈	603 x 610 x 1356	RID__-242454UFB	2,372
		<i>Specify the pull code (F, R). Specify the accent color (A, S).</i>		
	<i>1 cabinet on left, 2 file drawers, 1 wardrobe with clothes hanger bar on right.</i>			
	23 ³ / ₄ x 24 x 65 ¹ / ₂	603 x 610 x 1664	RID__-242466BFF	2,404
23 ³ / ₄ x 24 x 53 ³ / ₈	603 x 610 x 1356	RID__-242454BFF	2,340	
	<i>Specify the pull code (F, R). Specify the accent color (A, S).</i>			
<i>1 cabinet on right, 2 file drawers, 1 wardrobe with clothes hanger bar on left.</i>				
	23 ³ / ₄ x 24 x 65 ¹ / ₂	603 x 610 x 1664	RID__-242466FFB	2,404
	23 ³ / ₄ x 24 x 53 ³ / ₈	603 x 610 x 1356	RID__-242454FFB	2,340
		<i>Specify the pull code (F, R). Specify the accent color (A, S).</i>		
	<i>1 cabinet on left, 2 box drawers, 1 file drawer, 1 wardrobe with clothes hanger bar on right.</i>			
	23 ³ / ₄ x 24 x 65 ¹ / ₂	603 x 610 x 1664	RID__-242466BUF	2,438
23 ³ / ₄ x 24 x 53 ³ / ₈	603 x 610 x 1356	RID__-242454BUF	2,372	
	<i>Specify the pull code (K, M, Z, W). Specify the accent color (A, S).</i>			
<i>1 cabinet on right, 2 box drawers, 1 file drawer, 1 wardrobe with clothes hanger bar on left.</i>				
	23 ³ / ₄ x 24 x 65 ¹ / ₂	603 x 610 x 1664	RID__-242466UFB	2,438
	23 ³ / ₄ x 24 x 53 ³ / ₈	603 x 610 x 1356	RID__-242454UFB	2,372
		<i>Specify the pull code (K, M, Z, W). Specify the accent color (A, S).</i>		
	<i>1 cabinet on left, 2 file drawers, 1 wardrobe with clothes hanger bar on right.</i>			
	23 ³ / ₄ x 24 x 65 ¹ / ₂	603 x 610 x 1664	RID__-242466BFF	2,404
23 ³ / ₄ x 24 x 53 ³ / ₈	603 x 610 x 1356	RID__-242454BFF	2,340	
	<i>Specify the pull code (K, M, Z, W). Specify the accent color (A, S).</i>			
<i>1 cabinet on right, 2 file drawers, 1 wardrobe with clothes hanger bar on left.</i>				
	23 ³ / ₄ x 24 x 65 ¹ / ₂	603 x 610 x 1664	RID__-242466FFB	2,404
	23 ³ / ₄ x 24 x 53 ³ / ₈	603 x 610 x 1356	RID__-242454FFB	2,340
		<i>Specify the pull code (K, M, Z, W). Specify the accent color (A, S).</i>		
	<i>1 cabinet on left, 2 box drawers, 1 file drawer, 1 wardrobe with clothes hanger bar on right.</i>			
	23 ³ / ₄ x 24 x 65 ¹ / ₂	603 x 610 x 1664	RID__-242466BUF	2,438
23 ³ / ₄ x 24 x 53 ³ / ₈	603 x 610 x 1356	RID__-242454BUF	2,372	
	<i>Specify the pull code (K, M, Z, W). Specify the accent color (A, S).</i>			
<i>1 cabinet on right, 2 file drawers, 1 wardrobe with clothes hanger bar on left.</i>				

Combined towers with cabinet / wardrobe - external pulls	<i>1 cabinet on left, 2 box drawers, 1 file drawer, 1 wardrobe with clothes hanger bar on right.</i>			
	23 ³ / ₄ x 24 x 65 ¹ / ₂	603 x 610 x 1664	RID__-242466BUF	2,438
	23 ³ / ₄ x 24 x 53 ³ / ₈	603 x 610 x 1356	RID__-242454BUF	2,372
		<i>Specify the pull code (K, M, Z, W). Specify the accent color (A, S).</i>		
	<i>1 cabinet on right, 2 box drawers, 1 file drawer, 1 wardrobe with clothes hanger bar on left.</i>			
	23 ³ / ₄ x 24 x 65 ¹ / ₂	603 x 610 x 1664	RID__-242466UFB	2,438
	23 ³ / ₄ x 24 x 53 ³ / ₈	603 x 610 x 1356	RID__-242454UFB	2,372
		<i>Specify the pull code (K, M, Z, W). Specify the accent color (A, S).</i>		
	<i>1 cabinet on left, 2 file drawers, 1 wardrobe with clothes hanger bar on right.</i>			
	23 ³ / ₄ x 24 x 65 ¹ / ₂	603 x 610 x 1664	RID__-242466BFF	2,404
23 ³ / ₄ x 24 x 53 ³ / ₈	603 x 610 x 1356	RID__-242454BFF	2,340	
	<i>Specify the pull code (K, M, Z, W). Specify the accent color (A, S).</i>			
<i>1 cabinet on right, 2 file drawers, 1 wardrobe with clothes hanger bar on left.</i>				
	23 ³ / ₄ x 24 x 65 ¹ / ₂	603 x 610 x 1664	RID__-242466FFB	2,404
	23 ³ / ₄ x 24 x 53 ³ / ₈	603 x 610 x 1356	RID__-242454FFB	2,340
		<i>Specify the pull code (K, M, Z, W). Specify the accent color (A, S).</i>		
	<i>1 cabinet on left, 2 box drawers, 1 file drawer, 1 wardrobe with clothes hanger bar on right.</i>			
	23 ³ / ₄ x 24 x 65 ¹ / ₂	603 x 610 x 1664	RID__-242466BUF	2,438
23 ³ / ₄ x 24 x 53 ³ / ₈	603 x 610 x 1356	RID__-242454BUF	2,372	
	<i>Specify the pull code (K, M, Z, W). Specify the accent color (A, S).</i>			
<i>1 cabinet on right, 2 file drawers, 1 wardrobe with clothes hanger bar on left.</i>				











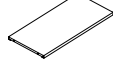

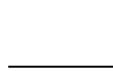
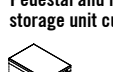



		W x D x H (in)	W x D x H (mm)	Code	Price (\$)
Combined towers with bookcase					
<i>1 bookcase on left, 2 box drawers, 1 file drawer.</i>					
		14 3/4 x 24 x 65 1/2	375 x 610 x 1664	RID__-PUF152466	1,919
		14 3/4 x 24 x 53 3/8	375 x 610 x 1356	RID__-PUF152454	1,857
Specify the pull code (F, R). Specify the accent color (A, S).					
<i>1 bookcase on right, 2 box drawers, 1 file drawer.</i>					
		14 3/4 x 24 x 65 1/2	375 x 610 x 1664	RID__-P152466UF	1,919
		14 3/4 x 24 x 53 3/8	375 x 610 x 1356	RID__-P152454UF	1,857
Specify the pull code (F, R). Specify the accent color (A, S).					
<i>1 bookcase on left, 2 file drawers.</i>					
		14 3/4 x 24 x 65 1/2	375 x 610 x 1664	RID__-PFF152466	1,894
		14 3/4 x 24 x 53 3/8	375 x 610 x 1356	RID__-PFF152454	1,834
Specify the pull code (F, R). Specify the accent color (A, S).					
<i>1 bookcase on right, 2 file drawers.</i>					
		14 3/4 x 24 x 65 1/2	375 x 610 x 1664	RID__-P152466FF	1,894
		14 3/4 x 24 x 53 3/8	375 x 610 x 1356	RID__-P152454FF	1,834
Specify the pull code (F, R). Specify the accent color (A, S).					
Electronic lock option (D): add \$675.					

Combined towers with bookcase - external pulls					
<i>1 bookcase on left, 2 box drawers, 1 file drawer.</i>					
		14 3/4 x 24 x 65 1/2	375 x 610 x 1664	RID__-PUF152466	1,919
		14 3/4 x 24 x 53 3/8	375 x 610 x 1356	RID__-PUF152454	1,857
Specify the pull code (K, M, Z, W). Specify the accent color (A, S).					
<i>1 bookcase on right, 2 box drawers, 1 file drawer.</i>					
		14 3/4 x 24 x 65 1/2	375 x 610 x 1664	RID__-P152466UF	1,919
		14 3/4 x 24 x 53 3/8	375 x 610 x 1356	RID__-P152454UF	1,857
Specify the pull code (K, M, Z, W). Specify the accent color (A, S).					
<i>1 bookcase on left, 2 file drawers.</i>					
		14 3/4 x 24 x 65 1/2	375 x 610 x 1664	RID__-PFF152466	1,894
		14 3/4 x 24 x 53 3/8	375 x 610 x 1356	RID__-PFF152454	1,834
Specify the pull code (K, M, Z, W). Specify the accent color (A, S).					
<i>1 bookcase on right, 2 file drawers.</i>					
		14 3/4 x 24 x 65 1/2	375 x 610 x 1664	RID__-P152466FF	1,894
		14 3/4 x 24 x 53 3/8	375 x 610 x 1356	RID__-P152454FF	1,834
Specify the pull code (K, M, Z, W). Specify the accent color (A, S).					
Electronic lock option (D): add \$675.					

Combined towers with bookcase / wardrobe - integrated pulls					
<i>1 bookcase on left, 2 box drawers, 1 file drawer, 1 wardrobe with clothes hanger bar on right.</i>					
		23 3/4 x 24 x 65 1/2	603 x 610 x 1664	RID__-PBUF242466	2,408
		23 3/4 x 24 x 53 3/8	603 x 610 x 1356	RID__-PBUF242454	2,296
Specify the pull code (F, R). Specify the accent color (A, S).					
<i>1 bookcase on right, 2 box drawers, 1 file drawer, 1 wardrobe with clothes hanger bar on left.</i>					
		23 3/4 x 24 x 65 1/2	603 x 610 x 1664	RID__-P242466BUF	2,408
		23 3/4 x 24 x 53 3/8	603 x 610 x 1356	RID__-P242454BUF	2,296
Specify the pull code (F, R). Specify the accent color (A, S).					
<i>1 bookcase on left, 2 file drawers, 1 wardrobe with clothes hanger bar on right.</i>					
		23 3/4 x 24 x 65 1/2	603 x 610 x 1664	RID__-PBFF242466	2,329
		23 3/4 x 24 x 53 3/8	603 x 610 x 1356	RID__-PBFF242454	2,266
Specify the pull code (F, R). Specify the accent color (A, S).					
<i>1 bookcase on right, 2 file drawers, 1 wardrobe with clothes hanger bar on left.</i>					
		23 3/4 x 24 x 65 1/2	603 x 610 x 1664	RID__-P242466BFF	2,329
		23 3/4 x 24 x 53 3/8	603 x 610 x 1356	RID__-P242454BFF	2,266
Specify the pull code (F, R). Specify the accent color (A, S).					

		W x D x H (in)	W x D x H (mm)	Code	Price (\$)
Combined towers with bookcase / wardrobe - external pulls					
<i>1 bookcase on left, 2 box drawers, 1 file drawer, 1 wardrobe with clothes hanger bar on right.</i>					
		23 3/4 x 24 x 65 1/2	603 x 610 x 1664	RID__-PBUF242466	2,359
		23 3/4 x 24 x 53 3/8	603 x 610 x 1356	RID__-PBUF242454	2,296
Specify the pull code (K, M, Z, W). Specify the accent color (A, S).					
<i>1 bookcase on right, 2 box drawers, 1 file drawer, 1 wardrobe with clothes hanger bar on left.</i>					
		23 3/4 x 24 x 65 1/2	603 x 610 x 1664	RID__-P242466BUF	2,359
		23 3/4 x 24 x 53 3/8	603 x 610 x 1356	RID__-P242454BUF	2,296
Specify the pull code (K, M, Z, W). Specify the accent color (A, S).					
<i>1 bookcase on left, 2 file drawers, 1 wardrobe with clothes hanger bar on right.</i>					
		23 3/4 x 24 x 65 1/2	603 x 610 x 1664	RID__-PBFF242466	2,329
		23 3/4 x 24 x 53 3/8	603 x 610 x 1356	RID__-PBFF242454	2,266
Specify the pull code (K, M, Z, W). Specify the accent color (A, S).					
<i>1 bookcase on right, 2 file drawers, 1 wardrobe with clothes hanger bar on left.</i>					
		23 3/4 x 24 x 65 1/2	603 x 610 x 1664	RID__-P242466BFF	2,329
		23 3/4 x 24 x 53 3/8	603 x 610 x 1356	RID__-P242454BFF	2,266
Specify the pull code (K, M, Z, W). Specify the accent color (A, S).					

ACCESSORIES

Additional shelves					
<i>Insert into the storage units lateral notches. No tool required.</i>					
<i>For bookcases.</i>					
	41 3/4 x 16 3/4 x 3/4	1060 x 425 x 19	RINNN-TB4218		167
	35 3/4 x 16 3/4 x 3/4	908 x 425 x 19	RINNN-TB3618		161
	29 3/4 x 16 3/4 x 3/4	756 x 425 x 19	RINNN-TB3018		153
<i>For cabinets.</i>					
	41 3/4 x 14 1/4 x 3/4	1060 x 362 x 19	RINNN-TA4218		167
	35 3/4 x 14 1/4 x 3/4	908 x 362 x 19	RINNN-TA3618		161
	29 3/4 x 14 1/4 x 3/4	756 x 362 x 19	RINNN-TA3018		153
Pedestal and low storage unit cushions					
<i>Attaches to a mobile pedestal or on a low storage unit with velcro strip. Prices shown apply to all Grade 1 and 2 United Chair® fabrics. For other United Chair® grades, add: Grade 3: 15%, Grade 4: 20%, Grade 5: 25% and Grade 6: 30%.</i>					
<i>For mobile pedestals.</i>					
	14 3/4 x 28 x 1 1/2	375 x 711 x 40	RINNN-CU1528		378
	14 3/4 x 22 x 1 1/2	375 x 559 x 40	RINNN-CU1522		290
	14 3/4 x 18 x 1 1/2	375 x 457 x 40	RINNN-CU1518		240
<i>For low storage units.</i>					
	42 x 18 x 1 1/2	1067 x 457 x 40	RINNN-CU4218		433
	36 x 18 x 1 1/2	914 x 457 x 40	RINNN-CU3618		394
	30 x 18 x 1 1/2	762 x 457 x 40	RINNN-CU3018		320
Counterweights					
<i>Installation required. Includes counterweight and attachment brackets. Counterweight may be factory installed by adding 'W' at the end of the product code.</i>					
<i>For vertical files with 2 or 3 drawers (VF2 to VF3):</i>					
	17 3/4" W		RINNN-CW18		304
	14 3/4" W		RINNN-CW15		290
<i>For low storage units, multifunction files and combined lateral cabinets/files with 1 drawer (BE, SLF, CO and LFB):</i>					
	42" W		RINNN-C3W42		498
	36" W		RINNN-C3W36		458
	30" W		RINNN-C3W30		362

METAL STORAGE FURNITURE

	W x D x H (in)	W x D x H (mm)	Code	Price (\$)
Counterweights (cont'd)	<i>For lateral files and combined lateral cabinets/files with 2 or 3 drawers (LF2 to LF3, LF2B and LF3B):</i>			
	42" W		RINNN-C2W42	498
	36" W		RINNN-C2W36	417
	30" W		RINNN-C2W30	320
	<i>For lateral files with 4 drawers (LF4):</i>			
	42" W		RINNN-C1W42	320
	36" W		RINNN-C1W36	304
	30" W		RINNN-C1W30	290

Paradigm storage-to-panel attachment filler

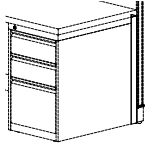

Shown: Installation on right (R)

Attaches to the back of a metal storage unit and to an Paradigm acoustical panel in order to replace a panel bracket. May be used with any surface with 2" (50 mm) more than the depth of the metal storage furniture. Installation and drilling required.

2 x 2 x 27¹/₈ 50 x 50 x 708 RINNN-EGM2_ 164

Specify installation on left (L) or right (R)

Front-to-back hanging bars for lateral file drawers

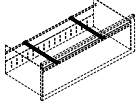

2-bar kit. To create 2 letter or legal-size filing rows, 4 bars are needed, except for the 42" wide drawer, which needs 6 bars to create 3 letter-size filing rows. See page 4 for further information about filing capacity.

15¹/₈ x 1¹/₄ x 1¹/₄ 384 x 32 x 32 LGC-FTB2 53

Ganging kit



Allows to attach two storage units back-to-back (2 or more drawers) or side-by-side (3 or more drawers). The mounting kit is an efficient alternative to the use of counterweights. Hole drilling required.

RINNN-GKIT 63

Divider for lateral file drawer or low storage unit box drawer

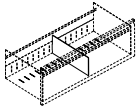

For lateral file or low storage unit utility drawer. Inserts into the drawer slots every 1" (25 mm).

18 x 1¹/₁₆ x 6 457 x 2 x 152 RINNN-DIV6 22

Magnetic dividers for lateral or vertical file



For vertical or lateral file.

6 x 15 x 6 152 x 381 x 152 RINNN-DIV186 87

6 x 12 x 6 152 x 305 x 152 RINNN-DIV156 87

For utility drawer.

2 x 15 x 2 51 x 381 x 51 RINNN-DIV182 74

2 x 12 x 2 51 x 305 x 51 RINNN-DIV152 74

Compressors

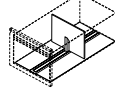

For vertical file. Comes with a grooved drawer bottom and a bracket with a clip.

Letter size. RINNN-COM15 112

Legal size. RINNN-COM18 112

Pencil tray for box drawer

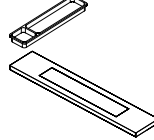

Black plastic. Sits on the sides of a 15" W (381 mm) utility drawer and slides from front to back for drawer access.

Pencil tray for multifunction unit 30" W.

12¹/₈ x 3 x 1 327 x 76 x 25 RINNN-PHU 40

Metal tray adaptors (pencil tray sold separately).

For multifunction unit 36" W RINNN-PHUA18 30

For multifunction unit 42" W RINNN-PHUA21 35

Label holders



Insert into the integrated pulls. Clear plastic.

For full pull (F) RINNN-PLHF 8

For recessed aluminum pull (R) RINNN-PLHR 8

Electronic locks



Installation and hole drilling required. For further information, see electronic lock specifications, page 5.

For lateral or vertical file (horizontal position).

5¹/₄ x 1/2 x 1¹/₄ 133 x 13 x 32 RINN_-DHLK 290

Specify the accent color (A, S).

For cabinet or wardrobe (vertical position).

1¹/₄ x 1/2 x 5¹/₄ 32 x 13 x 133 RINN_-DVUK 290

Specify the accent color (A, S).

Manager Key RINNN-DMK 137

Programming Key RINNN-DPK 202

Important:

For conditions of sale, the full product offering or more information on all Lacasse collections, please consult Lacasse's General Price Book.

Office Furniture Solutions

Founded in 1956, Groupe Lacasse is a North American leader in the design, manufacture and service of a broad range of high-quality furniture products for all types of work environments. We have the experience, expertise and capability to deliver incomparable design, exceptional quality, optimum service and outstanding value in Office Furniture Solutions.



1-888-522-2773

www.grounelacasse.com