

Office Doctor Discount Office Furniture

[www.OfficeDr.com](http://www.OfficeDr.com) 856-368-9085

Groupe Lacasse Half Price Sale On Now

Take Half Off the List Prices in this PDF

**Call 856-368-9085 Now**

Free Layout & Design Service

C.I.T.E. Height Adjustable Tables



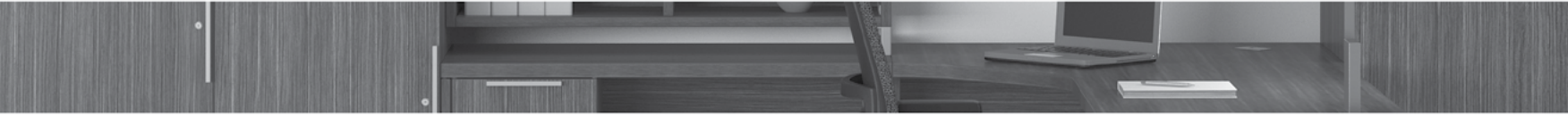

Electric height adjustable tables > C.I.T.É. Addendum > Canada > February 2025



OFFICE

FURNITURE

SOLUTIONS



The C.I.T.É. collection is the recipient of NeoCon Gold Award – Furniture Systems Category – June 2010  
The C.I.T.É. collection is the recipient of NeoCon Gold Award – Furniture Systems Enhancements Category – June 2015

## TABLE OF CONTENTS

### SPECIFICATIONS

ELECTRIC HEIGHT ADJUSTABLE TABLES .....	3
WIRE MANAGEMENT MODULES .....	4
SCREENS .....	4
ELECTRIFICATION .....	4
SPECIFICATION OF OPTIONS AND FINISHES .....	5

### C.I.T.É. ADDENDUM PRICE LIST

FREESTANDING HEIGHT ADJUSTABLE TABLES .....	5
WIRE MANAGEMENT MODULES .....	6
SCREENS .....	7
ELECTRIFICATION .....	7





# SPECIFICATIONS

## ELECTRIC HEIGHT ADJUSTABLE TABLES: ADDENDUM - C.I.T.É. - OFFICE FURNITURE SYSTEM

Electric height adjustable tables are very easy to use. They encourage active work (sitting/standing) and can be adjusted for users with different heights sharing the same workstation. Various base styles are offered.

### Electric height adjustment

- Control keypad is installed beneath the work surface.
- Operating speed: 1¼" (32 mm) height adjustment per second.
- Sound level: 48 dB.
- Lift capacity of 2 columns: 264 lbs (120 kg).
- Recommended functional load capacity: 125 lbs (56 kg).
- Failure to respect the loads can cause the table/desk to malfunction.
- 120" L (3048 mm) cable with plug for wall outlet.
- Meet CSA and UL standards.



Digital control keypad with memory

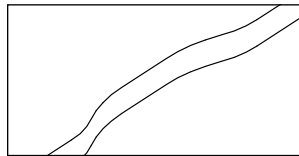

Smile-shaped middle cutout

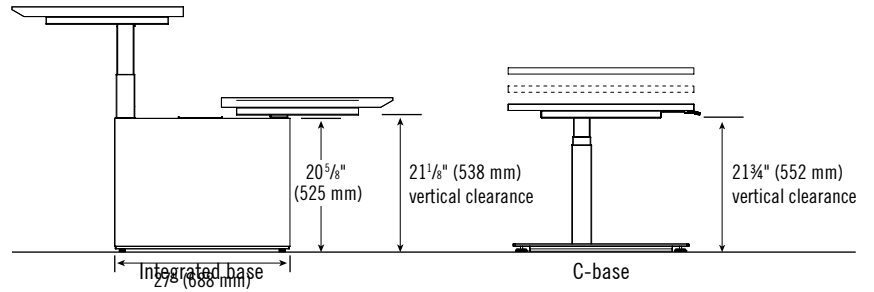

### Different base styles

	Integrated base (metal/laminate)	Freestanding C-base (metal)
<b>TOP 1" (25 mm)</b>		
Lowest position	23 3/8" (594 mm)	24" (607 mm)
Highest position	49" (1244 mm)	49 1/2" (1257 mm)
<b>TOP 1 1/2" (38 mm)</b>		
Lowest position	24" (606 mm)	24 1/2" (620 mm)
Highest position	49 1/2" (1256 mm)	50" (1270 mm)

### Electric height adjustable tables - integrated base

- When specified, the knife edge (K) is located on the user side only.
- Levelers with height adjustment of 1 1/2" (38 mm).
- The grommet option on the side of the bases allows cabling to pass through horizontally between 2 double-sided tables. A flexible horizontal fabric DW21 grommet is recommended.

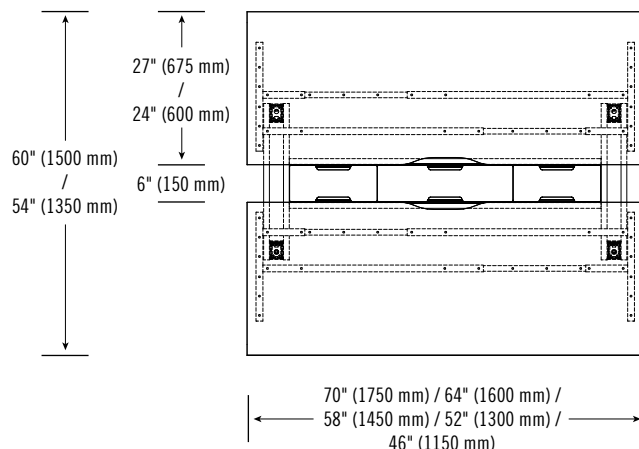

### Electric height adjustable tables - freestanding base

- When specified, the knife edge (K) is located on the side of the users only.
- Levelers with height adjustment of 3/4" (20 mm).
- C-base: rectangular column of 2 1/2" W x 3" D (62 mm x 80 mm). Foot of 3/4" W x 22" D (80 mm x 559 mm).

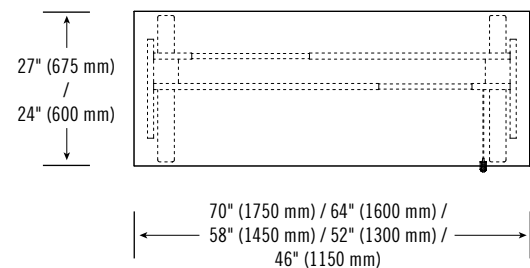

WIRE MANAGEMENT MODULES

Wire management modules and end panel

Wire management modules enable the creation of flexible and reconfigurable workstations when they are combined with electric height adjustable tables. End panels ensure the stability of single-sided and double-sided layouts.

- 22" high (561 mm), corresponding to the height of tables with double-sided surfaces and integrated bases. Offers a light and more effective layout.
- 29<sup>3</sup>/<sub>8</sub>" high (745 mm), compatible with a fixed C.I.T.É. table with 1" thick (25 mm) surfaces.
- 29<sup>7</sup>/<sub>8</sub>" high (757 mm), compatible with a fixed C.I.T.É. table with 1<sup>1</sup>/<sub>2</sub>" thick (38 mm) surfaces.
- A maximum length of 24' (7.2 m) for double-sided layouts and 16' (4.8 m) for single-sided layouts is recommended, regardless of the number of sections.
- Levelers with height adjustment of 1<sup>1</sup>/<sub>2</sub>" (38 mm).

When the components are assembled, the overall dimensions are planned according to a space required between 2 adjacent surfaces for wire management, which prevents fingers from getting pinched and allows the installation of surface privacy screens.

Double-sided layout

- Double-sided end panel bases, widths of 60" (1500 mm) or 66" (1650 mm).

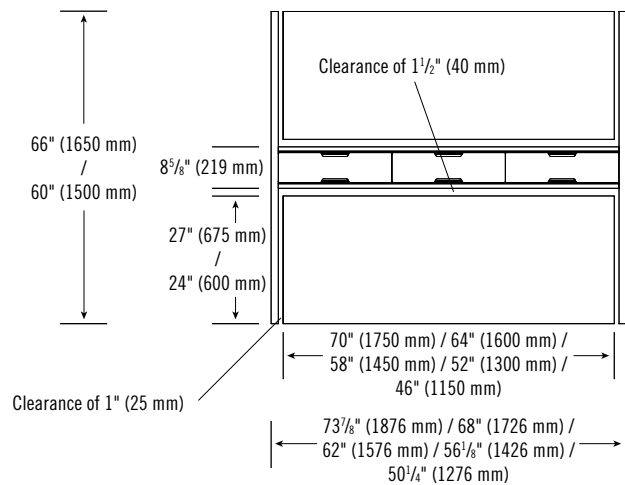

Single-sided layout

- Single-sided end panel bases, widths of 33<sup>7</sup>/<sub>8</sub>" (860 mm) or 36<sup>3</sup>/<sub>4</sub>" (935 mm).

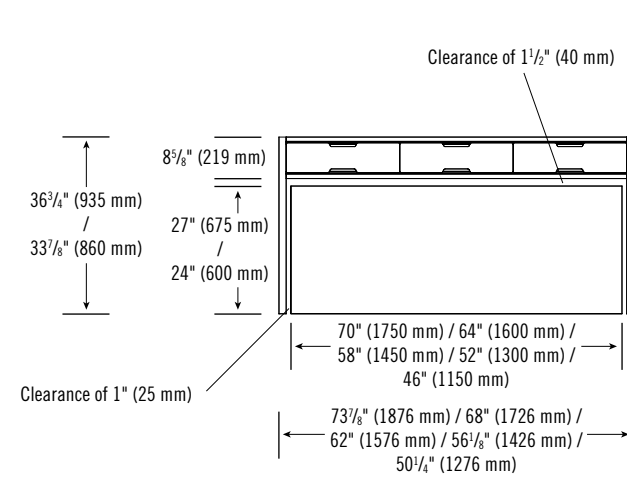

**Layout using the combination of a fixed C.I.T.É. furniture system and a freestanding wire management module.**

Example of an extension to a C.I.T.É. station containing fixed existing sections:

- 1 center panel base for double-sided surfaces CNNNS-LCAD6028.
- 1 wire management module CNNNS-LBAT7229.
- 1 end panel base CNN\_S-LEAD6029.
- 2 electric height adjustable tables C1NN\_-RCA2770G.

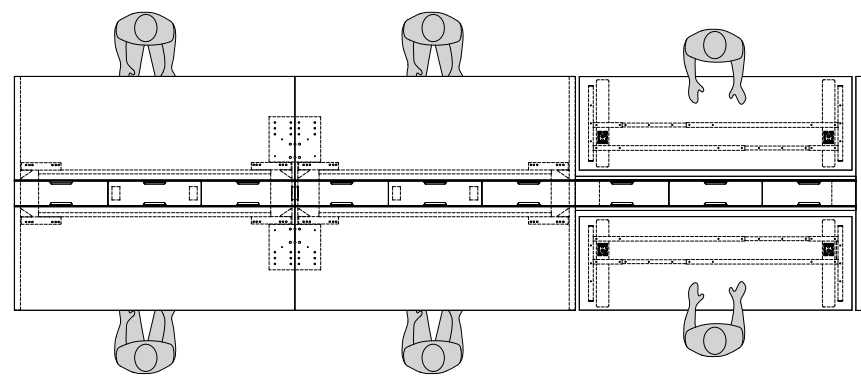

SCREENS

Screens help divide space depending on the level of privacy required while adding a warm touch to a workstation. They can be installed at the back or on the side of an electric height adjustable table surface.

- Panel composite of wood fibers, cardboard and recycled PVC covered in fabric.
- Fabric choice: see the current Lacasse upholstery guide. Vinyl and leather cannot be specified for screens. Available in 1 tone only.
- The fabric screens can be used as tackboards.
- Acrylic screens have a thickness of 1/4" (6 mm).
- The screens installed are 17<sup>3</sup>/<sub>4</sub>" high (450 mm) on a 1" (25 mm) surface and 17<sup>1</sup>/<sub>4</sub>" high (437 mm) on a 1<sup>1</sup>/<sub>2</sub>" (38 mm) surface.

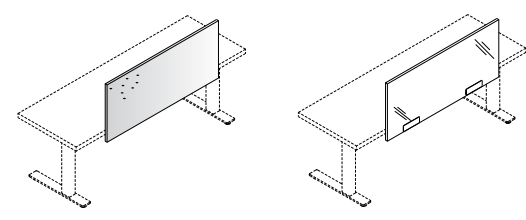

ELECTRIFICATION

Refer to the C.I.T.É. price book.

# ELECTRIC HEIGHT ADJUSTABLE TABLES

## C.I.T.É. ADDENDUM



### SPECIFICATION OF OPTIONS AND FINISHES

#### EDGEBANDING

Automatically applied to the top and the sides.

##### N Edge

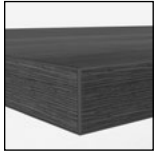

1" and 1½"  
(25 mm and 38 mm)

**N** edging matches the finish specified for the surface.

##### K Knife Edge

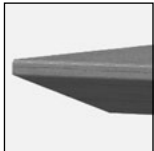

1½" (38 mm)

**K** knife-edge available (in coordinated colors) ONLY when a wood grain or Snow (SNO) finish is specified for the surface.

#### CODIFICATION

		Options					
Series	Thickness	Edgework	Options	Accent	Dash	Product	Options
C	1 Thermofused laminate 1" (25 mm)	<b>N</b> Smooth edge	<b>N</b> Base without grommet <b>1</b> Grommet on the base <b>2</b> Grommets on the base	<b>S</b> Silver <b>W</b> White	-		<b>D</b> Smile-shaped cutout on the surface
	2 High-pressure laminate 1" (25 mm)	<b>K</b> Knife-edge					
	5 Thermofused laminate 1½" (38 mm)						
	6 High-pressure laminate 1½" (38 mm)						

#### METAL BASES:

**S** - Silver or **W** - White



Integrated base



C-base

#### SCREENS / LATERAL SCREENS:

**Acrylic**



T - Translucent

**Fabric**



Several fabrics available. Refer to the current Lacasse upholstery selection guide.

### FREESTANDING HEIGHT ADJUSTABLE TABLES

Electric height adjustable table with double-sided surfaces and channel

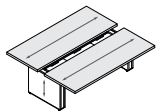

Smooth edge (N)

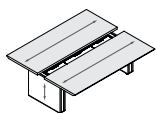

Knife-edge (K)

Smile-shaped cutout option on the surface, add D at the end of the code and \$135.

Double-sided surfaces with metal and laminate integrated bases as well as a channel for wire management. Translucent acrylic covers. 2 LGC-COM included. Compatible with privacy screens.

1" (25 mm) thick top. Lowest position is 23⅞" (594 mm) and highest position is 49" (1244 mm).

W x D x H (in)	W x D x H (mm)	Code	All Laminate (\$)	HPL Surfaces (\$)
70 x 60 x 23⅞-49	1750 x 1500 x 594-1244	<b>C_N__-RCDAT6070SG</b>	<b>7,830</b>	<b>8,139</b>
64 x 60 x 23⅞-49	1600 x 1500 x 594-1244	<b>C_N__-RCDAT6064SG</b>	<b>7,753</b>	<b>8,042</b>
58 x 60 x 23⅞-49	1450 x 1500 x 594-1244	<b>C_N__-RCDAT6058SG</b>	<b>7,685</b>	<b>7,947</b>
52 x 60 x 23⅞-49	1300 x 1500 x 594-1244	<b>C_N__-RCDAT6052SG</b>	<b>7,611</b>	<b>7,848</b>
46 x 60 x 23⅞-49	1150 x 1500 x 594-1244	<b>C_N__-RCDAT6046SG</b>	<b>7,544</b>	<b>7,753</b>
70 x 54 x 23⅞-49	1750 x 1350 x 594-1244	<b>C_N__-RCDAT5470SG</b>	<b>7,790</b>	<b>8,072</b>
64 x 54 x 23⅞-49	1600 x 1350 x 594-1244	<b>C_N__-RCDAT5464SG</b>	<b>7,725</b>	<b>7,983</b>
58 x 54 x 23⅞-49	1450 x 1350 x 594-1244	<b>C_N__-RCDAT5458SG</b>	<b>7,655</b>	<b>7,887</b>
52 x 54 x 23⅞-49	1300 x 1350 x 594-1244	<b>C_N__-RCDAT5452SG</b>	<b>7,590</b>	<b>7,796</b>
46 x 54 x 23⅞-49	1150 x 1350 x 594-1244	<b>C_N__-RCDAT5446SG</b>	<b>7,523</b>	<b>7,706</b>

Specify the surface type (1, 2). Specify if grommet in the base (N, 1, 2). Specify accent color (S, W).

1½" (38 mm) thick top. Lowest position is 24" (606 mm) and highest position is 49½" (1256 mm).

W x D x H (in)	W x D x H (mm)	Code	All Laminate (\$)	HPL Surfaces (\$)
70 x 60 x 24-49½	1750 x 1500 x 606-1256	<b>C_N__-RCDAT6070SG</b>	<b>7,977</b>	<b>8,289</b>
64 x 60 x 24-49½	1600 x 1500 x 606-1256	<b>C_N__-RCDAT6064SG</b>	<b>7,887</b>	<b>8,176</b>
58 x 60 x 24-49½	1450 x 1500 x 606-1256	<b>C_N__-RCDAT6058SG</b>	<b>7,805</b>	<b>8,065</b>
52 x 60 x 24-49½	1300 x 1500 x 606-1256	<b>C_N__-RCDAT6052SG</b>	<b>7,725</b>	<b>7,960</b>
46 x 60 x 24-49½	1150 x 1500 x 606-1256	<b>C_N__-RCDAT6046SG</b>	<b>7,642</b>	<b>7,848</b>
70 x 54 x 24-49½	1750 x 1350 x 606-1256	<b>C_N__-RCDAT5470SG</b>	<b>7,924</b>	<b>8,206</b>
64 x 54 x 24-49½	1600 x 1350 x 606-1256	<b>C_N__-RCDAT5464SG</b>	<b>7,842</b>	<b>8,102</b>
58 x 54 x 24-49½	1450 x 1350 x 606-1256	<b>C_N__-RCDAT5458SG</b>	<b>7,766</b>	<b>7,999</b>
52 x 54 x 24-49½	1300 x 1350 x 606-1256	<b>C_N__-RCDAT5452SG</b>	<b>7,685</b>	<b>7,894</b>
46 x 54 x 24-49½	1150 x 1350 x 606-1256	<b>C_N__-RCDAT5446SG</b>	<b>7,611</b>	<b>7,790</b>

Specify the surface type (5, 6). Specify if grommet in the base (N, 1, 2). Specify accent color (S, W).

W x D x H (in)	W x D x H (mm)	Code	All Laminate (\$)	HPL Surfaces (\$)
----------------	----------------	------	-------------------	-------------------

Electric height adjustable table with double-sided surfaces and channel (cont'd)

1½" (38 mm) thick top with knife edge. Lowest position is 24" (606 mm) and highest position is 49½" (1256 mm).				
70 x 60 x 24-49½	1750 x 1500 x 606-1256	<b>C_K__-RCDAT6070SG</b>	<b>8,521</b>	<b>8,833</b>
64 x 60 x 24-49½	1600 x 1500 x 606-1256	<b>C_K__-RCDAT6064SG</b>	<b>8,429</b>	<b>8,721</b>
58 x 60 x 24-49½	1450 x 1500 x 606-1256	<b>C_K__-RCDAT6058SG</b>	<b>8,348</b>	<b>8,609</b>
52 x 60 x 24-49½	1300 x 1500 x 606-1256	<b>C_K__-RCDAT6052SG</b>	<b>8,268</b>	<b>8,503</b>
46 x 60 x 24-49½	1150 x 1500 x 606-1256	<b>C_K__-RCDAT6046SG</b>	<b>8,184</b>	<b>8,393</b>
70 x 54 x 24-49½	1750 x 1350 x 606-1256	<b>C_K__-RCDAT5470SG</b>	<b>8,469</b>	<b>8,751</b>
64 x 54 x 24-49½	1600 x 1350 x 606-1256	<b>C_K__-RCDAT5464SG</b>	<b>8,387</b>	<b>8,660</b>
58 x 54 x 24-49½	1450 x 1350 x 606-1256	<b>C_K__-RCDAT5458SG</b>	<b>8,311</b>	<b>8,573</b>
52 x 54 x 24-49½	1300 x 1350 x 606-1256	<b>C_K__-RCDAT5452SG</b>	<b>8,231</b>	<b>8,483</b>
46 x 54 x 24-49½	1150 x 1350 x 606-1256	<b>C_K__-RCDAT5446SG</b>	<b>8,146</b>	<b>8,393</b>

Specify the surface type (5, 6). Specify if grommet in the base (N, 1, 2). Specify accent color (S, W).

Electric height adjustable rectangular tables, metal C-base

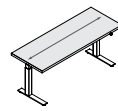

Smooth edge (N)

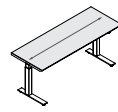

Knife-edge (K)

Smile-shaped cutout option on the surface, add D at the end of the code and \$135.

Metal C-base. 10' (3040 mm) cable with cord. Compatible with privacy screens. 1 tone only.

1" (25 mm) thick top. Lowest position is 24" (607 mm) and highest position is 49½" (1257 mm).

70 x 27 x 24-49½	1750 x 675 x 607-1257	<b>C_NN_-RCA2770G</b>	<b>3,010</b>	<b>3,218</b>
64 x 27 x 24-49½	1600 x 675 x 607-1257	<b>C_NN_-RCA2764G</b>	<b>2,994</b>	<b>3,188</b>
58 x 27 x 24-49½	1450 x 675 x 607-1257	<b>C_NN_-RCA2758G</b>	<b>2,978</b>	<b>3,157</b>
52 x 27 x 24-49½	1300 x 675 x 607-1257	<b>C_NN_-RCA2752G</b>	<b>2,965</b>	<b>3,129</b>
46 x 27 x 24-49½	1150 x 675 x 607-1257	<b>C_NN_-RCA2746G</b>	<b>2,948</b>	<b>3,106</b>
70 x 24 x 24-49½	1750 x 600 x 607-1257	<b>C_NN_-RCA2470G</b>	<b>2,965</b>	<b>3,157</b>
64 x 24 x 24-49½	1600 x 600 x 607-1257	<b>C_NN_-RCA2464G</b>	<b>2,958</b>	<b>3,129</b>
58 x 24 x 24-49½	1450 x 600 x 607-1257	<b>C_NN_-RCA2458G</b>	<b>2,941</b>	<b>3,106</b>
52 x 24 x 24-49½	1300 x 600 x 607-1257	<b>C_NN_-RCA2452G</b>	<b>2,927</b>	<b>3,082</b>
46 x 24 x 24-49½	1150 x 600 x 607-1257	<b>C_NN_-RCA2446G</b>	<b>2,920</b>	<b>3,053</b>

Specify the surface type (1, 2). Specify accent color (S, W).

2-TONE LAMINATE APPLICATION: SHADED AREA CORRESPONDS TO THE FIRST CODE TO BE SPECIFIED. SECOND LAMINATE CODE WILL BE APPLIED TO THE REST OF THE PRODUCT.

= ASSEMBLY REQUIRED



W x D x H (in)	W x D x H (mm)	Code	All Laminate (\$)	HPL Surfaces (\$)
<b>Electric height adjustable rectangular tables, metal C-base (cont'd)</b>				
<i>1½" (38 mm) thick top. Lowest position is 24½" (620 mm) and highest position is 50" (1270 mm).</i>				
70 x 27 x 24½-50	1750 x 675 x 620-1270	<b>C_NN_-RCA2770G</b>	<b>3,076</b>	<b>3,306</b>
64 x 27 x 24½-50	1600 x 675 x 620-1270	<b>C_NN_-RCA2764G</b>	<b>3,053</b>	<b>3,278</b>
58 x 27 x 24½-50	1450 x 675 x 620-1270	<b>C_NN_-RCA2758G</b>	<b>3,031</b>	<b>3,241</b>
52 x 27 x 24½-50	1300 x 675 x 620-1270	<b>C_NN_-RCA2752G</b>	<b>3,010</b>	<b>3,203</b>
46 x 27 x 24½-50	1150 x 675 x 620-1270	<b>C_NN_-RCA2746G</b>	<b>2,986</b>	<b>3,167</b>
70 x 24 x 24½-50	1750 x 600 x 620-1270	<b>C_NN_-RCA2470G</b>	<b>3,038</b>	<b>3,179</b>
64 x 24 x 24½-50	1600 x 600 x 620-1270	<b>C_NN_-RCA2464G</b>	<b>3,024</b>	<b>3,149</b>
58 x 24 x 24½-50	1450 x 600 x 620-1270	<b>C_NN_-RCA2458G</b>	<b>3,000</b>	<b>3,119</b>
52 x 24 x 24½-50	1300 x 600 x 620-1270	<b>C_NN_-RCA2452G</b>	<b>2,986</b>	<b>3,090</b>
46 x 24 x 24½-50	1150 x 600 x 620-1270	<b>C_NN_-RCA2446G</b>	<b>2,965</b>	<b>3,053</b>

Specify the surface type (5, 6). Specify accent color (S, W).

*1½" (38 mm) thick top with knife edge. Lowest position is 24½" (620 mm) and highest position is 50" (1270 mm).*

70 x 27 x 24½-50	1750 x 675 x 620-1270	<b>C_KN_-RCA2770G</b>	<b>3,404</b>	<b>3,619</b>
64 x 27 x 24½-50	1600 x 675 x 620-1270	<b>C_KN_-RCA2764G</b>	<b>3,382</b>	<b>3,581</b>
58 x 27 x 24½-50	1450 x 675 x 620-1270	<b>C_KN_-RCA2758G</b>	<b>3,359</b>	<b>3,543</b>
52 x 27 x 24½-50	1300 x 675 x 620-1270	<b>C_KN_-RCA2752G</b>	<b>3,336</b>	<b>3,508</b>
46 x 27 x 24½-50	1150 x 675 x 620-1270	<b>C_KN_-RCA2746G</b>	<b>3,306</b>	<b>3,470</b>
70 x 24 x 24½-50	1750 x 600 x 620-1270	<b>C_KN_-RCA2470G</b>	<b>3,354</b>	<b>3,493</b>
64 x 24 x 24½-50	1600 x 600 x 620-1270	<b>C_KN_-RCA2464G</b>	<b>3,329</b>	<b>3,464</b>
58 x 24 x 24½-50	1450 x 600 x 620-1270	<b>C_KN_-RCA2458G</b>	<b>3,314</b>	<b>3,426</b>
52 x 24 x 24½-50	1300 x 600 x 620-1270	<b>C_KN_-RCA2452G</b>	<b>3,291</b>	<b>3,396</b>
46 x 24 x 24½-50	1150 x 600 x 620-1270	<b>C_KN_-RCA2446G</b>	<b>3,269</b>	<b>3,359</b>

Specify the surface type (5, 6). Specify accent color (S, W).

**Double-sided end panel bases for wire management module - 29" H**



*Full 1½" (38 mm) thick end panel. To be used with a laminate wire management module. 1 tone only.*

W x D x H (in)	W x D x H (mm)	Code	All Laminate (\$)	HPL Surfaces (\$)
<i>29¾" high (745 mm) bases:</i>				
66 x 1½ x 29¾	1650 x 38 x 745	<b>CNN_S-LEAD6629</b>	<b>433</b>	
60 x 1½ x 29¾	1500 x 38 x 745	<b>CNN_S-LEAD6029</b>	<b>408</b>	

Specify if grommet in the base (N, 1).

<i>29" high (757 mm) bases:</i>				
66 x 1½ x 29"	1650 x 38 x 757	<b>CNN_S-LEAD6630</b>	<b>440</b>	
60 x 1½ x 29"	1500 x 38 x 757	<b>CNN_S-LEAD6030</b>	<b>417</b>	

Specify if grommet in the base (N, 1).

**Double-sided end panel bases for wire management module - 22" H**



*Full 1½" (38 mm) thick end panel. To be used with a laminate wire management module. 1 tone only.*

66 x 1½ x 22	1650 x 38 x 561	<b>CNN_S-LEAD6622</b>	<b>381</b>	
60 x 1½ x 22	1500 x 38 x 561	<b>CNN_S-LEAD6022</b>	<b>364</b>	

Specify if grommet in the base (N, 1).

**Single-sided end panel bases for wire management module - 29" H**



Left (L)



Right (R)

*Full 1½" (38 mm) thick end panel. To be used with a laminate wire management module. 1 tone only.*

W x D x H (in)	W x D x H (mm)	Code	All Laminate (\$)	HPL Surfaces (\$)
<i>29¾"-tall (745 mm) bases:</i>				
36¾ x 1½ x 29¾	935 x 38 x 745	<b>CNN_S-LEAS3629_</b>	<b>320</b>	
33⅞ x 1½ x 29¾	860 x 38 x 745	<b>CNN_S-LEAS3329_</b>	<b>313</b>	

Specify if grommet in the base (N, 1). Specify left (L) or right (R).

<i>29" tall (757 mm) bases:</i>				
36¾ x 1½ x 29"	935 x 38 x 757	<b>CNN_S-LEAS3630_</b>	<b>328</b>	
33⅞ x 1½ x 29"	860 x 38 x 757	<b>CNN_S-LEAS3330_</b>	<b>313</b>	

Specify if grommet in the base (N, 1). Specify left (L) or right (R).

**Single-sided end panel bases for wire management module - 22" H**



Left (L)



Right (R)

*Full 1½" (38 mm) thick end panel. To be used with a laminate wire management module. 1 tone only.*

36¾ x 1½ x 22	935 x 38 x 561	<b>CNN_S-LEAS3622_</b>	<b>290</b>	
33⅞ x 1½ x 22	860 x 38 x 561	<b>CNN_S-LEAS3322_</b>	<b>285</b>	

Specify if grommet in the base (N, 1). Specify left (L) or right (R).

**Center panel base for double-sided surfaces**

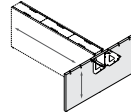

*1½" (38 mm) full center panel base. Goes at the junction of fixed C.I.T.É. surfaces and a 29" H electrification and communication module. Hardware included. 1 tone only.*

60 x 1½ x 28	1500 x 38 x 719	<b>CNNNS-LCAD6028</b>	<b>642</b>	
--------------	-----------------	-----------------------	------------	--

**WIRE MANAGEMENT MODULES**

**Wire management modules - 29" H**

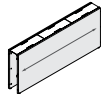

*Laminate module. Wire channels with anodized aluminum edges and translucent acrylic covers. 2 LGC-COM included. Must be used with end panel bases. 1 tone only.*

<i>29¾" high (745 mm) modules for 1" thick (25 mm) top:</i>				
72 x 7⅞ x 29¾	1800 x 219 x 745	<b>CNNNS-LBAT7229</b>	<b>1,437</b>	
66 x 7⅞ x 29¾	1650 x 219 x 745	<b>CNNNS-LBAT6629</b>	<b>1,354</b>	
60 x 7⅞ x 29¾	1500 x 219 x 745	<b>CNNNS-LBAT6029</b>	<b>1,268</b>	
54 x 7⅞ x 29¾	1350 x 219 x 745	<b>CNNNS-LBAT5429</b>	<b>1,186</b>	
48 x 7⅞ x 29¾	1200 x 219 x 745	<b>CNNNS-LBAT4829</b>	<b>1,102</b>	

<i>29" high (757 mm) modules for 1½" thick (38 mm) top:</i>				
72 x 7⅞ x 29"	1800 x 219 x 757	<b>CNNNS-LBAT7230</b>	<b>1,458</b>	
66 x 7⅞ x 29"	1650 x 219 x 757	<b>CNNNS-LBAT6630</b>	<b>1,378</b>	
60 x 7⅞ x 29"	1500 x 219 x 757	<b>CNNNS-LBAT6030</b>	<b>1,289</b>	
54 x 7⅞ x 29"	1350 x 219 x 757	<b>CNNNS-LBAT5430</b>	<b>1,198</b>	
48 x 7⅞ x 29"	1200 x 219 x 757	<b>CNNNS-LBAT4830</b>	<b>1,118</b>	

**Wire management modules - 22" H**

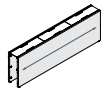

*Laminate module. Wire channels with anodized aluminum edges and translucent acrylic covers. 2 LGC-COM included. Must be used with end panel bases. 1 tone only.*

72 x 7⅞ x 22	1800 x 219 x 561	<b>CNNNS-LBAT7222</b>	<b>1,333</b>	
66 x 7⅞ x 22	1650 x 219 x 561	<b>CNNNS-LBAT6622</b>	<b>1,259</b>	
60 x 7⅞ x 22	1500 x 219 x 561	<b>CNNNS-LBAT6022</b>	<b>1,192</b>	
54 x 7⅞ x 22	1350 x 219 x 561	<b>CNNNS-LBAT5422</b>	<b>1,118</b>	
48 x 7⅞ x 22	1200 x 219 x 561	<b>CNNNS-LBAT4822</b>	<b>1,050</b>	

2-TONE LAMINATE APPLICATION: SHADED AREA CORRESPONDS TO THE FIRST CODE TO BE SPECIFIED. SECOND LAMINATE CODE WILL BE APPLIED TO THE REST OF THE PRODUCT.

= ASSEMBLY REQUIRED

W x D x H (in) W x D x H (mm) Code Price (\$)

**SCREENS**

Refer to the current Lacasse upholstery selection guide.

**Privacy screens for surface**

Tackable fabric screens. Mount to electric height adjustable tables.

Privacy screens	Gr1	Gr2	Gr3	Gr4	Gr5	Gr6	Gr8
70 x 3/4 x 18 1750 x 19 x 513 <b>CNNNS-SCAF7018</b>	843	895	947	973	1,063	1,172	1,325
64 x 3/4 x 18 1600 x 19 x 513 <b>CNNNS-SCAF6418</b>	824	870	917	942	1,026	1,124	1,263
58 x 3/4 x 18 1450 x 19 x 513 <b>CNNNS-SCAF5818</b>	803	844	890	910	985	1,078	1,199
52 x 3/4 x 18 1300 x 19 x 513 <b>CNNNS-SCAF5218</b>	704	745	783	802	870	950	1,061
46 x 3/4 x 18 1150 x 19 x 513 <b>CNNNS-SCAF4618</b>	606	642	676	692	752	824	924
<i>Lateral privacy screens</i>							
27 x 3/4 x 18 675 x 19 x 513 <b>CNNNS-SCAF2718</b>	574	591	613	623	657	701	760
24 x 3/4 x 18 600 x 19 x 513 <b>CNNNS-SCAF2418</b>	558	578	599	606	639	677	729

Specify the fabric code at the end of the product code.

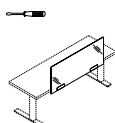
**Privacy screens for surface**

Acrylic screens. Mount to electric height adjustable tables.

Privacy screens	
70 x 1/4 x 18 1750 x 6 x 513 <b>CNNN_-SCAT7018</b>	642
64 x 1/4 x 18 1600 x 6 x 513 <b>CNNN_-SCAT6418</b>	617
58 x 1/4 x 18 1450 x 6 x 513 <b>CNNN_-SCAT5818</b>	604
52 x 1/4 x 18 1300 x 6 x 513 <b>CNNN_-SCAT5218</b>	580
46 x 1/4 x 18 1150 x 6 x 513 <b>CNNN_-SCAT4618</b>	537
<i>Lateral privacy screens</i>	
27 x 1/4 x 18 675 x 6 x 513 <b>CNNN_-SCAT2718</b>	499
24 x 1/4 x 18 600 x 6 x 513 <b>CNNN_-SCAT2418</b>	454

Specify accent color (S, W).

**ELECTRIFICATION**
**Electric kit for channel and modules**

4 duplex receptacles with cables. Black. Compatible with 72" (1800 mm) to 48" (1200 mm) wire management modules and 70" (1750 mm) to 60" (1500 mm) long integrated bases tables.



<b>LGC-4TRAC472C_</b>	566
-----------------------	-----

Specify circuit number at the end of the code (1, 2).

**Pass cable**

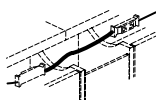

Connects 2 adjacent channels.



<b>LGC-PASS36</b>	191
-------------------	-----

**Electrical feed from floor**

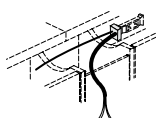

72" (1828 mm) long cable. Must be installed by an electrician.



<b>LGC-FFEED72</b>	300
--------------------	-----

**Electrical ceiling feed**

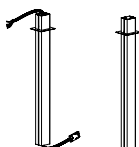
**Post and cable:** 120" (3000 mm) tall aluminum post. Silver. 132" (3353 mm) long cable. Screws and supports included. Must be installed by an electrician.



<b>CNNNS-CFEED120</b>	729
-----------------------	-----

**Post:** 120" (3000 mm) tall aluminum post. Silver.

<b>CNNNS-POLE120</b>	567
----------------------	-----

**Flexible horizontal fabric grommet**



Allows cabling to be managed horizontally. 2" (50 mm) diameter. With zipper. All Lacasse standard fabrics are applicable.

	Gr1	Gr2	Gr3	Gr4	Gr5	Gr6	Gr8
2 x 2 x 21 50 x 50 x 533 <b>DVW21</b>	114	115	130	133	144	156	177

Specify the fabric code at the end of the product code.

= ASSEMBLY REQUIRED

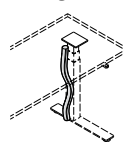
W x D x H (in) W x D x H (mm) Code Price (\$)

**Flexible vertical fabric grommet**

Allows cabling to be managed vertically. 2" diameter. With zipper. All Lacasse standard fabrics are applicable.

	Gr1	Gr2	Gr3	Gr4	Gr5	Gr6	Gr8
2 x 2 x 39 50 x 50 x 991 <b>DVW34</b>	130	131	140	144	159	173	192

Specify the fabric code at the end of the product code.

**Wire management clips**

Allow cables to be clipped under the work surface. Grey. Package of 5 clips.

5 1/2 x 1 1/2 x 1 140 x 40 x 25 <b>LGC-WMC05</b>	140
--	-----



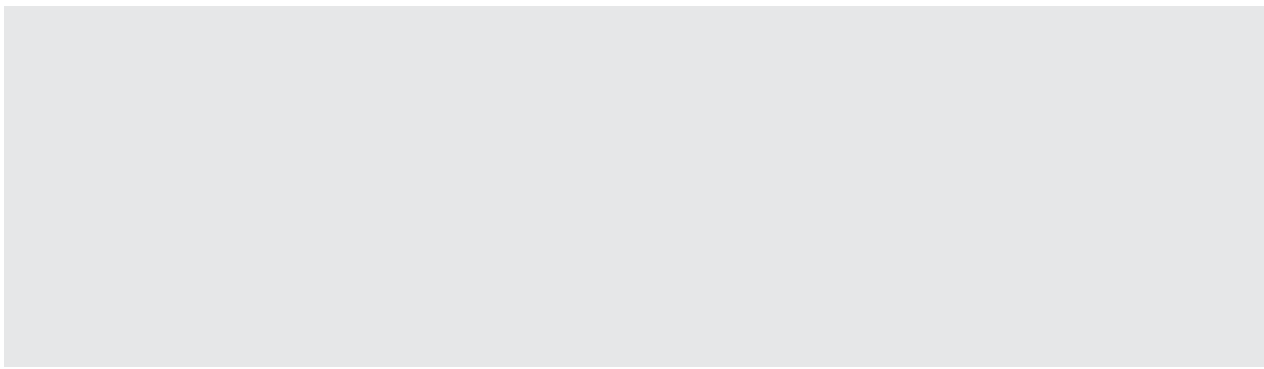

## Office Furniture Solutions

Founded in 1956, Groupe Lacasse is a North American leader in the design, manufacture and service of a broad range of high-quality furniture products for all types of work environments. We have the experience, expertise and capability to deliver incomparable design, exceptional quality, optimum service and outstanding value in Office Furniture Solutions.



1-888-522-2773  
[www.groupelacasse.com](http://www.groupelacasse.com)



Groupe Lacasse has achieved GREENGUARD GOLD Certification.  
GREENGUARD Certified products are certified to GREENGUARD standards for low chemical emissions into indoor air during product usage. For more information, visit [ul.com/gg](http://ul.com/gg).