

Office Doctor Discount Office Furniture

www.OfficeDr.com 856-368-9085

Groupe Lacasse Half Price Sale On Now

Take Half Off the List Prices in this PDF

Call 856-368-9085 Now

Free Layout & Design Service

Concept 3 Series



CONCEPT 3

IIDEX Awards
NeoCon Canada



CONCEPT 3 – EASY TO SPECIFY, EASY TO RECONFIGURE

3 LAYOUTS

Concept 3 envisions three classic office workstation layouts – **traditional T, U-shaped** and **L-shaped** – with generous surfaces and versatile storage. Inspired design ensures upscale looks and maximum functionality whichever setting you choose.

REVERSIBLE

As easy as flipping a coin, storage and non-handed work surfaces fit together left or right. In the **U-shaped** and **L-shaped** settings, you can attach the bridge or work surface on either side without losing access to the storage below. A big plus if you change your space... or change your mind!

3 HEIGHTS

Keep it sleek and low with the **33-inch** storage module, elevate the look to **49 inches** or top it off at **73 inches**. Each level has its own refined sense of proportion and scale.

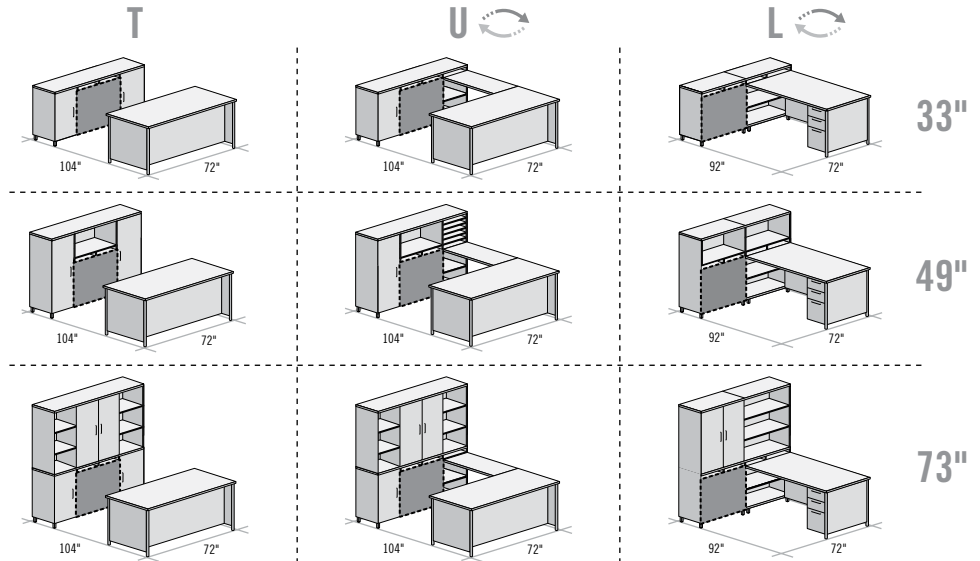

3 SURFACE SHAPES

Customize the look and function of your work surface with the shape you prefer – classic **rectangular R**, stylish **bow front A** or our adaptable **Y shape**.

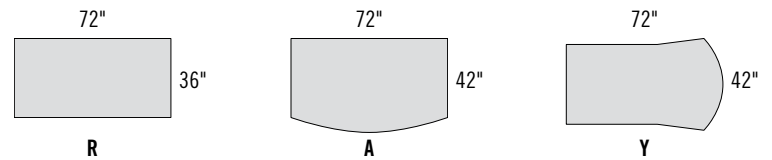

3 STORAGE OPTIONS

Choose from **storage modules** designed for filing, or for a multiplicity of functions with drawers and open bookcase. Whatever works best for you.

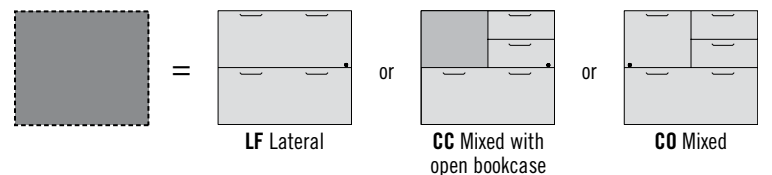

DOOR OPTIONS

Concept 3 is designed to simplify your life, but you still have the final say. Choose from matching **laminated N** or **anodized aluminum frame T** door styles. Storage modules are shipped assembled but offer you the flexibility of modifying the door configuration on site.

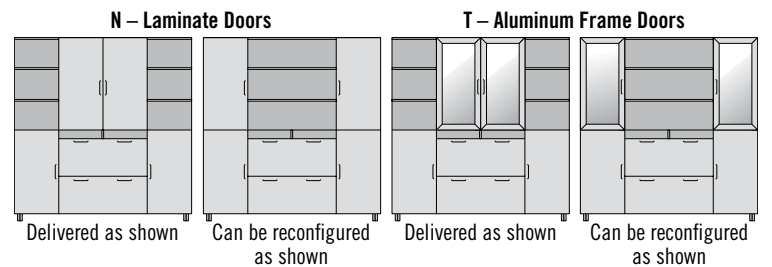

SPECIFIC TWO-TONE APPLICATION ON 73", 49" AND 33" H STORAGE UNITS (unless otherwise specified)

The first finish specified will be applied to the laminate door(s) and to the drawer at the bottom of the unit. The second finish specified will be applied to the rest of the unit.

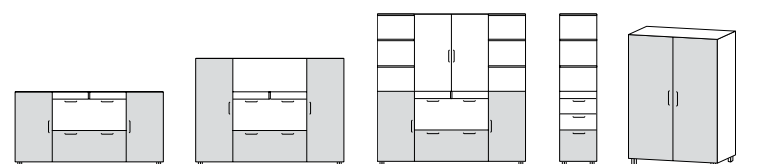

EDGEBANDING

Furniture with 1" (25 mm) thick tops.

N Edge



Smooth, 1/16" (1,5 mm) thick edge.

The **N** edge is **matched with the finish specified for the surface.**

HANDLES

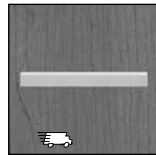

C – Cubic

CODIFICATION

Series	Options
	Doors
C3	T Translucent

LACASSE QUICKSHIP PROGRAM*

Products and suggested layouts identified by this pictogram are part of the Lacasse QuickShip delivery program.

Please refer to page 3 for complete program details.

* Due to current market conditions, always refer to our Lead-Time Guide for a confirmation of our current Lacasse QuickShip lead-times.



	W x D x H (in)	W x D x H (mm)	Code	Price (\$)
Rectangular surfaces 	<i>Can accommodate 1 or 2 modular pedestals. Recessed, full-height modesty panel.</i>			
	72 x 36 x 29	1800 x 900 x 735	C3-TD3672	1,409
	66 x 30 x 29	1650 x 750 x 735	C3-TD3066	1,207

	W x D x H (in)	W x D x H (mm)	Code	Price (\$)
Arched surfaces 	<i>Can accommodate 1 or 2 modular pedestals. Recessed, full-height modesty panel.</i>			
	72 x 42 x 29	1800 x 1050 x 735	C3-TD4272A	1,550
	66 x 36 x 29	1650 x 900 x 735	C3-TD3666A	1,375

	W x D x H (in)	W x D x H (mm)	Code	Price (\$)
Y-shaped surfaces 	<i>Reversible. Half-height modesty panel. Grommet. Can not accommodate pedestal.</i>			
	72 x 42 x 29	1800 x 1050 x 735	C3-YTM3672	1,467
	66 x 42 x 29	1650 x 1050 x 735	C3-YTM3666	1,375

	W x D x H (in)	W x D x H (mm)	Code	Price (\$)
Rectangular surface-returns 	<i>Reversible. Can accommodate 1 modular pedestal. Can be attached to a 36" wide bookcase. Recessed, full-height modesty panel. Grommet.</i>			
	72 x 36 x 29	1800 x 900 x 735	C3-RD3672	1,190
	66 x 36 x 29	1650 x 900 x 735	C3-RD3666	1,096
	54 x 36 x 29	1350 x 900 x 735	C3-RD3654	1,033

	W x D x H (in)	W x D x H (mm)	Code	Price (\$)
Y-shaped surface-returns 	<i>Reversible. Must be attached to a 36" wide bookcase. Half-height modesty panel. Grommet. Can not accommodate pedestal.</i>			
	72 x 42 x 29	1800 x 1050 x 735	C3-YUM3672	1,223
	66 x 42 x 29	1650 x 1050 x 735	C3-YUM3666	1,140
	54 x 42 x 29	1350 x 1050 x 735	C3-YUM3654	1,096

	W x D x H (in)	W x D x H (mm)	Code	Price (\$)
Modular pedestal 	<i>2 file drawers with suspension bars. Lock. Goes under a work surface. 1 tone only.</i>			
	15 x 24 x 24 3/4	388 x 600 x 628	C3-FF24	1,023

	W x D x H (in)	W x D x H (mm)	Code	Price (\$)
Modular pedestal 	<i>2 box drawers. 1 file drawer with suspension bar. Pencil tray. Lock. Goes under a work surface. 1 tone only.</i>			
	15 x 24 x 24 3/4	388 x 600 x 628	C3-UF24	1,132

	W x D x H (in)	W x D x H (mm)	Code	Price (\$)
Bridge-returns 	<i>Half-height modesty panel. Grommet.</i>			
	48 x 18 x 13	1200 x 448 x 327	C3-BR1848	454
	42 x 18 x 13	1050 x 448 x 327	C3-BR1842	412

	W x D x H (in)	W x D x H (mm)	Code	Price (\$)
Executive return 	<i>Reversible. 2 box drawers and 1 file drawer. Pencil tray. Grommet on the back. Lock.</i>			
	48 x 24 x 29	1200 x 600 x 735	C3-UF2448R	1,851

Packaged in 2 boxes.

	W x D x H (in)	W x D x H (mm)	Code	Price (\$)
73" Storage modules – 4 doors	<i>UPPER: Open bookcases, 4 adjustable shelves. Bookcase with doors, 2 adjustable shelves. Doors can be installed at either ends. Grommet on the back. Specify T at the end of the code for translucent doors.</i>			
	<i>LOWER: Bookcases with doors, 2 adjustable shelves. 2 pigeonholes. Packaged in 2 boxes.</i>			

	W x D x H (in)	W x D x H (mm)	Code	Price (\$)
Lateral file modules	<i>2 file drawers with suspension bars. Lock.</i>			
	72 x 20 x 73	1796 x 500 x 1850	C3-207273LFB	5,141
	72 x 20 x 73	1796 x 500 x 1850	C3-207273LFBT	6,075

	W x D x H (in)	W x D x H (mm)	Code	Price (\$)
Mixed modules	<i>2 box drawers, 2 file drawers with suspension bars. Lock. Pencil tray.</i>			
	72 x 20 x 73	1796 x 500 x 1850	C3-207273COB	5,545
	72 x 20 x 73	1796 x 500 x 1850	C3-207273COBT	6,480



	W x D x H (in)	W x D x H (mm)	Code	Price (\$)
Open mixed modules	<i>Open storage space. 2 box drawers. 1 file drawer with suspension bar. Lock. Pencil tray.</i>			
	72 x 20 x 73	1796 x 500 x 1850	C3-207273CCB	5,321
	72 x 20 x 73	1796 x 500 x 1850	C3-207273CCBT	6,234





	W x D x H (in)	W x D x H (mm)	Code	Price (\$)
73" Storage modules – 3 doors	<i>UPPER: Open bookcases, 2 adjustable shelves. Bookcase with doors, 2 adjustable shelves. Doors can be installed at either ends. Grommet on the back. Specify T at the end of the code for translucent doors.</i>			
	<i>LOWER: Reversible. Bookcases with door, adjustable shelf. 3 pigeonholes. Open Bookcase, adjustable shelf. A bridge-return can be attached. Packaged in two boxes.</i>			

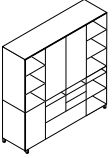
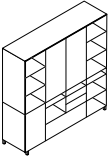

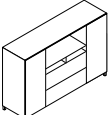
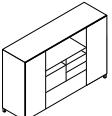
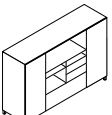
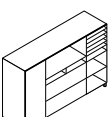
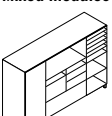
	W x D x H (in)	W x D x H (mm)	Code	Price (\$)
Lateral file modules	<i>2 file drawers with suspension bars. Lock.</i>			
	72 x 20 x 73	1796 x 500 x 1850	C3-207273LFS	5,048
	72 x 20 x 73	1796 x 500 x 1850	C3-207273LFS T	5,976

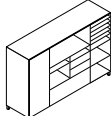
= ASSEMBLY REQUIRED

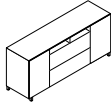
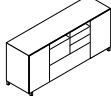
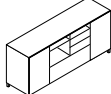

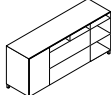
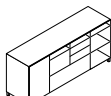
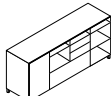

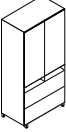
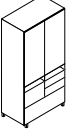
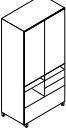
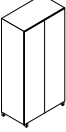
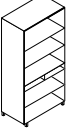
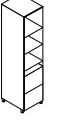
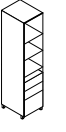

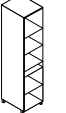

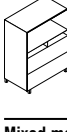
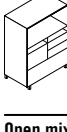
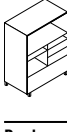
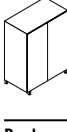
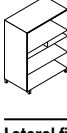
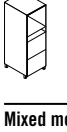
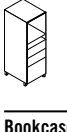
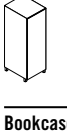
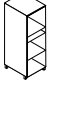
= QUICKSHIP PROGRAM

	W x D x H (in)	W x D x H (mm)	Code	Price (\$)
73" Storage modules – 3 doors (cont'd)				
Mixed modules	<i>2 box drawers, 2 file drawers with suspension bars. Lock. Pencil tray.</i>			
	72 x 20 x 73	1796 x 500 x 1850	C3-207273COS	5,472
	72 x 20 x 73	1796 x 500 x 1850	C3-207273COST	6,394
Open mixed modules	<i>Open storage space. 2 box drawers. 1 file drawer with suspension bar. Lock. Pencil tray.</i>			
	72 x 20 x 73	1796 x 500 x 1850	C3-207273CCS 	5,254
	72 x 20 x 73	1796 x 500 x 1850	C3-207273CCST 	6,187
49" Storage modules – 2 doors	<i>Bookcases with doors, 4 adjustable shelves. Open storage space. 2 pigeonholes. Grommet on the back. Specify T at the end of the code for translucent doors.</i>			
Lateral file modules	<i>2 file drawers with suspension bars. Lock.</i>			
	72 x 20 x 49	1796 x 500 x 1241	C3-207249LFB	3,392
	72 x 20 x 49	1796 x 500 x 1241	C3-207249LFBT	4,434
Mixed modules	<i>2 box drawers, 2 file drawers with suspension bars. Lock. Pencil tray.</i>			
	72 x 20 x 49	1796 x 500 x 1241	C3-207249COB	3,715
	72 x 20 x 49	1796 x 500 x 1241	C3-207249COBT	4,736
Open mixed modules	<i>Open storage space. 2 box drawers. 1 file drawer with suspension bar. Lock. Pencil tray.</i>			
	72 x 20 x 49	1796 x 500 x 1241	C3-207249CCB	3,484
	72 x 20 x 49	1796 x 500 x 1241	C3-207249CCBT	4,360
49" Storage modules – 1 door	<i>Reversible. Bookcase with door, 2 adjustable shelves. Open storage space. 8 pigeonholes. Open bookcase, adjustable shelf. Grommet on the back. A bridge-return can be attached. Specify T at the end of the code for translucent doors.</i>			
Lateral file modules	<i>2 file drawers with suspension bars. Lock.</i>			
	72 x 20 x 49	1796 x 500 x 1241	C3-207249LFS	3,478
	72 x 20 x 49	1796 x 500 x 1241	C3-207249LFST	3,973
Mixed modules	<i>2 box drawers, 2 file drawers with suspension bars. Lock. Pencil tray.</i>			
	72 x 20 x 49	1796 x 500 x 1241	C3-207249COS	3,781
	72 x 20 x 49	1796 x 500 x 1241	C3-207249COST	4,300

	W x D x H (in)	W x D x H (mm)	Code	Price (\$)
49" Storage modules – 1 door (cont'd)				
Open mixed modules	<i>Open storage space. 2 box drawers. 1 file drawer with suspension bar. Lock. Pencil tray.</i>			
	72 x 20 x 49	1796 x 500 x 1241	C3-207249CCS 	3,578
	72 x 20 x 49	1796 x 500 x 1241	C3-207249CCST 	4,089
33" Storage modules – 2 doors	<i>Bookcases with doors, 2 adjustable shelves. 2 pigeonholes. Specify T at the end of the code for translucent doors.</i>			
Lateral file modules	<i>2 file drawers with suspension bars. Lock.</i>			
	72 x 20 x 33	1796 x 500 x 834	C3-207233LFB	3,000
	72 x 20 x 33	1796 x 500 x 834	C3-207233LFBT	3,781
Mixed modules	<i>2 box drawers, 2 file drawers with suspension bars. Lock. Pencil tray.</i>			
	72 x 20 x 33	1796 x 500 x 834	C3-207233COB	3,437
	72 x 20 x 33	1796 x 500 x 834	C3-207233COBT	4,200
Open mixed modules	<i>Open storage space. 2 box drawers. 1 file drawer with suspension bar. Lock. Pencil tray.</i>			
	72 x 20 x 33	1796 x 500 x 834	C3-207233CCB 	3,203
	72 x 20 x 33	1796 x 500 x 834	C3-207233CCBT 	3,923
33" Storage modules – 1 door	<i>Reversible. Bookcase with doors, adjustable shelf. 3 pigeonholes. Open bookcase, adjustable shelf. A bridge-return can be attached. Specify T at the end of the code for translucent doors.</i>			
Lateral file modules	<i>2 file drawers with suspension bars. Lock.</i>			
	72 x 20 x 33	1796 x 500 x 834	C3-207233LFS	2,917
	72 x 20 x 33	1796 x 500 x 834	C3-207233LFST	3,304
Mixed modules	<i>2 box drawers, 2 file drawers with suspension bars. Lock. Pencil tray.</i>			
	72 x 20 x 33	1796 x 500 x 834	C3-207233COS	3,356
	72 x 20 x 33	1796 x 500 x 834	C3-207233COST	3,723
Open mixed modules	<i>Open storage space. 2 box drawers. 1 file drawer with suspension bar. Lock. Pencil tray.</i>			
	72 x 20 x 33	1796 x 500 x 834	C3-207233CCS	3,142
	72 x 20 x 33	1796 x 500 x 834	C3-207233CCST	3,493

	W x D x H (in)	W x D x H (mm)	Code	Price (\$)
73" COMPLEMENTARY STORAGE MODULES				
Lateral file modules	<i>Bookcase with doors, 2 adjustable shelves. 2 pigeonholes. 2 file drawers with suspension bars. Lock. Grommet on the back. Specify T at the end of the code for translucent doors.</i>			
	36 x 20 x 73	900 x 500 x 1850	C3-203673LF	3,304
	36 x 20 x 73	900 x 500 x 1850	C3-203673LFT	4,250
Mixed modules	<i>Bookcase with doors, 2 adjustable shelves. 2 pigeonholes. 2 box drawers. 2 file drawers with suspension bars. Lock. Pencil tray. Grommet on the back. Specify T at the end of the code for translucent doors.</i>			
	36 x 20 x 73	900 x 500 x 1850	C3-203673C0	3,636
	36 x 20 x 73	900 x 500 x 1850	C3-203673C0T	4,551
Open mixed modules	<i>Bookcase with doors, 2 adjustable shelves. 2 pigeonholes. Open storage space. 2 box drawers. 1 file drawer with suspension bar. Lock. Pencil tray. Grommet on the back. Specify T at the end of the code for translucent doors.</i>			
	36 x 20 x 73	900 x 500 x 1850	C3-203673CC	3,392
	36 x 20 x 73	900 x 500 x 1850	C3-203673CCT	4,308
Bookcase modules with doors	<i>3 adjustable shelves and 1 fixed shelf. 1 clothes hanger bar. Specify T at the end of the code for translucent doors.</i>			
	36 x 20 x 73	900 x 500 x 1850	C3-203673B	2,279
	36 x 20 x 73	900 x 500 x 1850	C3-203673BT	3,614
Bookcase modules	<i>Fixed shelf at 29". 3 adjustable shelves. 2 pigeonholes. Grommet on the back. A surface-return can be attached. 1 tone only.</i>			
	36 x 20 x 73	900 x 500 x 1850	C3-BS203673	2,088
Lateral file module	<i>Bookcase, 2 adjustable shelves. Pigeonhole. 2 file drawers with suspension bars. Lock.</i>			
	18 x 20 x 73	450 x 500 x 1850	C3-201873FF	2,139
Mixed module	<i>Bookcase, 2 adjustable shelves. Pigeonhole. 2 box drawers. 1 file drawer with suspension bar. Pencil tray. Lock.</i>			
	18 x 20 x 73	450 x 500 x 1850	C3-201873UF	2,271
Bookcase modules with door	<i>Reversible door. 4 adjustable shelves. Specify T at the end of the code for translucent door.</i>			
	18 x 20 x 73	450 x 500 x 1850	C3-201873B	1,770
	18 x 20 x 73	450 x 500 x 1850	C3-201873BT	2,397
Bookcase module	<i>3 adjustable shelves. Pigeonhole. A bridge-return can be attached. 1 tone only.</i>			
	18 x 20 x 73	450 x 500 x 1850	C3-BS201873	1,566

	W x D x H (in)	W x D x H (mm)	Code	Price (\$)
49" COMPLEMENTARY STORAGE MODULES				
Lateral file module	<i>Open storage space. 2 pigeonholes. 2 file drawers with suspension bars. Lock. Grommet on the back.</i>			
	36 x 20 x 49	900 x 500 x 1241	C3-203649LF	2,190
Mixed module	<i>Open storage space. 2 pigeonholes. 2 box drawers. 2 file drawers with suspension bars. Lock. Pencil tray. Grommet on the back.</i>			
	36 x 20 x 49	900 x 500 x 1241	C3-203649C0	2,580
Open mixed module	<i>Open storage space. 2 pigeonholes. 2 box drawers. 1 file drawer with suspension bar. Lock. Pencil tray. Grommet on the back.</i>			
	36 x 20 x 49	900 x 500 x 1241	C3-203649CC	2,362
Bookcase modules with doors	<i>2 adjustable shelves. 1 clothes hanger bar. Specify T at the end of the code for translucent doors.</i>			
	36 x 20 x 49	900 x 500 x 1241	C3-203649B	1,686
	36 x 20 x 49	900 x 500 x 1241	C3-203649BT	2,653
Bookcase module	<i>Open storage space. 2 pigeonholes. Fixed shelf at 29". Adjustable shelf. Grommet on the back. A surface-return can be attached. 1 tone only.</i>			
	36 x 20 x 49	900 x 500 x 1241	C3-BS203649	1,534
Lateral file module	<i>Open storage space. Pigeonhole. 2 file drawers with suspension bars. Lock.</i>			
	18 x 20 x 49	450 x 500 x 1241	C3-201849FF	1,726
Mixed module	<i>Open storage space. Pigeonhole. 2 box drawers. 1 file drawer with suspension bar. Pencil tray. Lock.</i>			
	18 x 20 x 49	450 x 500 x 1241	C3-201849UF	1,843
Bookcase modules with door	<i>Reversible door. 2 adjustable shelves. Specify T at the end of the code for translucent door.</i>			
	18 x 20 x 49	450 x 500 x 1241	C3-201849B	1,370
	18 x 20 x 49	450 x 500 x 1241	C3-201849BT	1,794
Bookcase module	<i>Open storage space. Pigeonhole. Adjustable shelf. A bridge-return can be attached. 1 tone only.</i>			
	18 x 20 x 49	450 x 500 x 1241	C3-BS201849	1,241

	W x D x H (in)	W x D x H (mm)	Code	Price (\$)
33" COMPLEMENTARY STORAGE MODULES				
Lateral file module	<i>2 pigeonholes. 2 file drawers with suspension bars. Lock.</i>			
	36 x 20 x 33	900 x 500 x 834	C3-203633LF	1,944
Mixed module	<i>2 pigeonholes. 2 box drawers. 2 file drawers with suspension bars. Lock. Pencil tray.</i>			
	36 x 20 x 33	900 x 500 x 834	C3-203633C0	2,313
Open mixed module	<i>2 pigeonholes. Open storage space. 2 box drawers. File drawer with suspension bar. Lock. Pencil tray.</i>			
	36 x 20 x 33	900 x 500 x 834	C3-203633CC	2,110
Bookcase modules with doors	<i>Adjustable shelf. Specify T at the end of the code for translucent doors.</i>			
	36 x 20 x 33	900 x 500 x 834	C3-203633B	1,419
	36 x 20 x 33	900 x 500 x 834	C3-203633BT	2,154
Bookcase module	<i>2 pigeonholes. Adjustable shelf. A surface-return can be attached. 1 tone only.</i>			
	36 x 20 x 33	900 x 500 x 834	C3-BS203633	1,223
Lateral file module	<i>Pigeonhole. 2 file drawers with suspension bars. Lock.</i>			
	18 x 20 x 33	450 x 500 x 834	C3-201833FF	1,526
Mixed module	<i>Pigeonhole. 2 box drawers. 1 file drawer with suspension bar. Lock. Pencil tray.</i>			
	18 x 20 x 33	450 x 500 x 834	C3-201833UF	1,661
Bookcase modules with door	<i>Reversible door. Adjustable shelf. Specify T at the end of the code for translucent door.</i>			
	18 x 20 x 33	450 x 500 x 834	C3-201833B	1,172
	18 x 20 x 33	450 x 500 x 834	C3-201833BT	1,491

SUGGESTIONS

C3-PLAN01

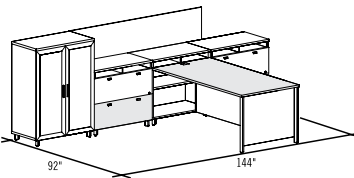

C3-PLAN01	\$9,589
1 C3-203649BT	
2 C3-203633LF	
1 C3-BS203633	
1 C3-RD3672	
1 LGC-TK8421M	

Cabinet with translucent doors (T).

Other option:

Cabinet with laminate doors.	\$8,617
------------------------------	----------------

C3-PLAN02

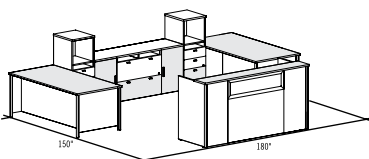

C3-PLAN02	\$12,521
2 C3-TD3672	
2 C3-201849UF	
1 C3-207233LFB	
1 C3-GS3084ST	

Cabinet with laminate doors.

Other option:

Cabinet with translucent doors (T).	\$13,301
-------------------------------------	-----------------

C3-PLAN04

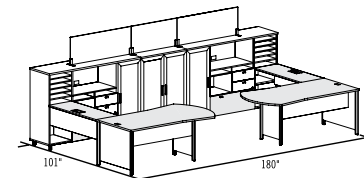

C3-PLAN04	\$16,788
2 C3-YTM3672	
2 C3-BR1848	
2 C3-207249CCST	
1 C3-203649BT	
3 C3NN-SCT3618	

Cabinets with translucent doors (T).

Other option:

Cabinets with laminate doors	\$14,793
------------------------------	-----------------

C3-PLAN05

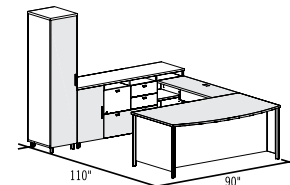

QSC3-PLAN05	\$7,122
1 QSC3-201873B	
1 QSC3-207233C0S	
1 QSC3-BR1848	
1 QSC3-TD4272A	







Cabinets with laminate doors.

Other option:

Cabinets with translucent doors (T).	\$8,122
--------------------------------------	----------------

	W x D x H (in)	W x D x H (mm)	Code	Price (\$)
Bookcase module	<i>Pigeonhole. Adjustable shelf. A bridge-return can be attached. 1 tone only.</i>			
	18 x 20 x 33	450 x 500 x 834	C3-BS201833	1,006

COMPLEMENTARY FURNITURE

Mobile pedestals	<i>2 box drawers. 1 file drawer with suspension bar. Brakes on front casters. Lock. Pencil tray. Fits under a work surface. 1 tone only.</i>			
	15 x 23 x 27 ¹ / ₈	390 x 575 x 689	C3-MP1523UF	1,358
	15 x 18 x 27 ¹ / ₈	390 x 450 x 689	C3-MP1518UF	1,274
Mobile pedestal	<i>2 file drawers with suspension bars. Brakes on front casters. Lock. Fits under a work surface. 1 tone only.</i>			
	15 x 23 x 27 ¹ / ₈	390 x 575 x 689	C3-MP1523FF	1,146
Mobile pedestals	<i>1 box drawer, 1 file drawer with suspension bar. Brakes on front casters. Lock. Pencil tray. Fits under a work surface. 1 tone only.</i>			
	15 x 23 x 20 ³ / ₄	390 x 575 x 527	C3-MP1523F	1,123
	15 x 18 x 20 ³ / ₄	390 x 450 x 527	C3-MP1518F	1,083
Hanging combination pedestal	<i>1 box drawer and 1 file drawer with suspension bar. Pencil tray. Lock. Must be installed under a work surface. 1 tone only.</i>			
	15 x 18 x 19 ¹ / ₄	388 x 448 x 489	C3-F	938
Conference table	<i>Cross base with anodized aluminum legs.</i>			
	42 x 42 x 29	1050 x 1050 x 735	C3-R42CR	1,207
Conference tables	<i>1" thick top. Laminate base with anodized aluminium legs.</i>			
	120 x 42 x 29	3000 x 1050 x 735	C3-REC42120	1,968
	96 x 42 x 29	2400 x 1050 x 735	C3-REC4296	1,476
	72 x 42 x 29	1800 x 1050 x 735	C3-REC4272	1,315
	120 x 48 x 29	3000 x 1200 x 735	C3-REC48120	2,139
	96 x 48 x 29	2400 x 1200 x 735	C3-REC4896	1,641

42" x 120" and 48" x 120": packaged in 2 boxes.