



Get Your Bespoke Office Design Today

We'll Get You The Right Office Furniture

Call Now (856)-368-9085

Call Now To Order (856) 368-9085

50% OFF Sale On Now

Nationwide Delivery and Installation

Office Doctor Discount Office Furniture

www.OfficeDr.com 856-368-9085

Groupe Lacasse Half Price Sale On Now

Take Half Off the List Prices in this PDF

Call 856-368-9085 Now

Free Layout & Design Service

Electricom

Electric and Data Management



ELECTRICOM II Electrification System

GENERAL

Electrical and communication system fully compatible with Lacasse collections.

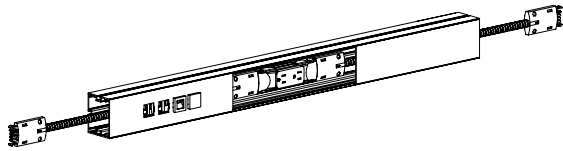

Electricom II is based on the principle that an aluminum raceway can serve to house both electrical and communication components. This versatile raceway may then be positioned at the desired location.

TYPICAL APPLICATIONS

Freestanding furniture

Concept 3, 70, 400E, 300, Morpheo, Quad, Options

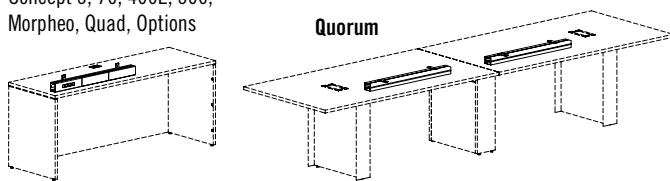

TWO LEVELS OF ELECTRIFICATION

4-Trac

- 4 wires, 2 circuits, 20 AMP
- Common ground
- UL, CSA, ROHS certified
- Perfect for today's office automation needs

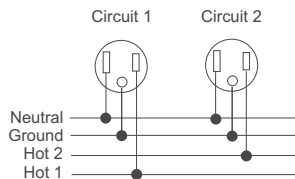
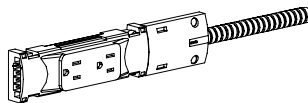

8-Trac

- 8 wires, 4 circuits, 20 AMP
- 1 isolated ground
- UL, CSA, ROHS certified
- Intended for more demanding electrification needs

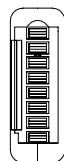
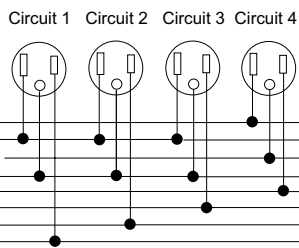
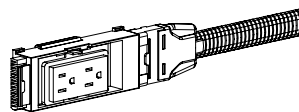

COMPONENT SPECIFICATIONS

Raceways

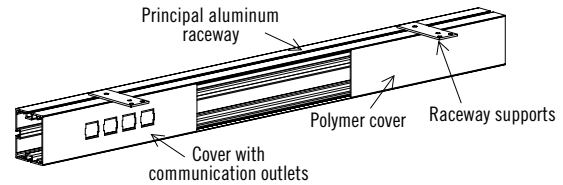

Can accommodate 4 AMP or Panduit brand outlets adapted to fax machines, telephones or computers.

- The raceways support the electrical and communication components.
- 5 lengths are available, in 12" increments.
- 12" covers supplied; may be trimmed on-site as necessary.
- The covers and duplex receptacles have no pre-set location within the raceway; they may be positioned anywhere.



- The supports make possible a range of installation positions:

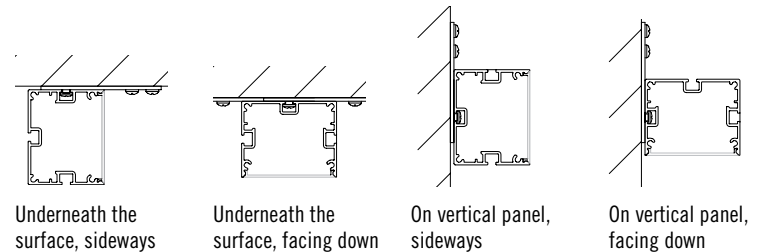

Space allocation within raceways:

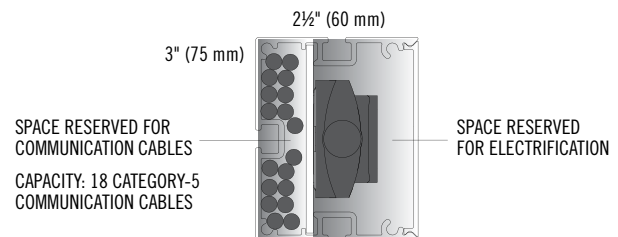

- When specifying, it is recommended to order a raceway in the size immediately smaller than the dimension of the furniture it will be installed on (for example: DT2472 + EC2RACE60) in order to allow space for exteriors, enable cables to round a corner, or any other reason.

4-TRAC DUPLEX

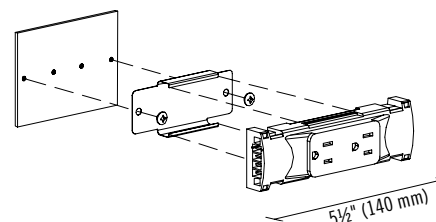

- Connects to a junction cable or an electrical entry.
- Each duplex receptacle comes with required hardware and support to fix on raceway.
- 2 outlets per duplex receptacle.
- Specify circuit 1 or 2.



8-TRAC BLOCK

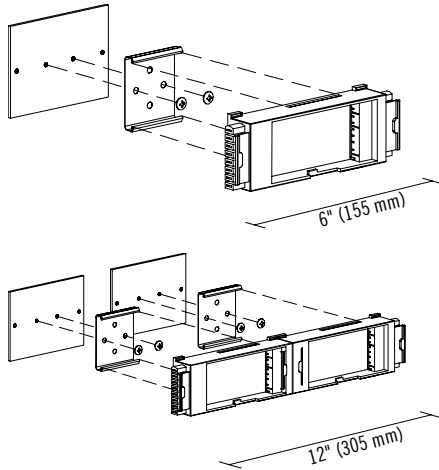

- Connects to a junction cable or an electrical entry.
- Each block comes with required hardware and supports to fix on raceway.
- Available in single and double formats.
- Can receive 1 or 2 duplex receptacles.

8-TRAC DUPLEX

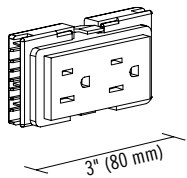

- Connects to an 8-Trac block.
- 2 outlets per duplex receptacle.
- Specify circuit 1, 2, 3 or 4.
- Circuit 4 has an isolated ground.

4-TRAC / 8-TRAC CONNECTOR CABLES

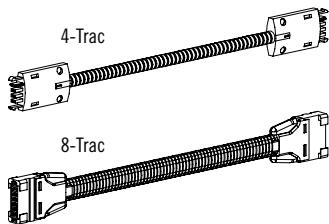

- Connect duplex receptacles to each other.
- If in doubt, it is recommended that the largest size available be specified.
- Metallic sheath.

4-TRAC / 8-TRAC FLOOR FEED

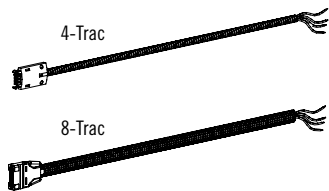

- Used to connect a duplex to electrical power source.
- 72" in length. (Longer models available; contact the Customer Service department.)
- Must be installed by an electrician.
- Metallic sheath.

4-TRAC / 8-TRAC CEILING FEED

- Runs from the Lacasse unit to the ceiling.
- The cable is plugged into a duplex.
- Pole: 120"; cable: 132".

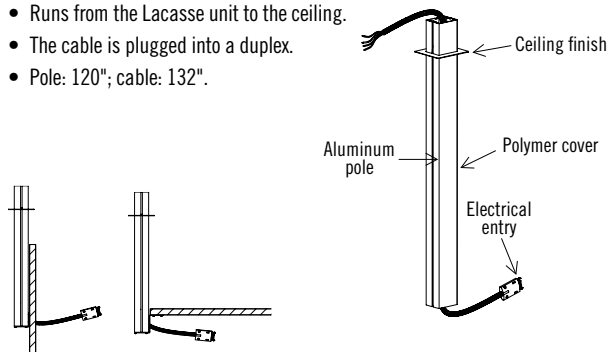

- Can be installed on a horizontal or vertical surface.

CONNECTORS

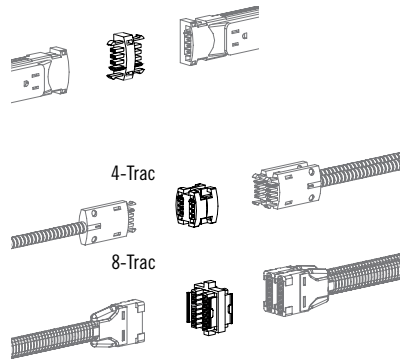

Duplex receptacle connector

- 4-Trac
- Allows the connection of 2 duplex receptacles.

H connector

- 4-Trac / 8-Trac
- Allows up to 4 cables to be connected together.

NOTES FOR SPECIFICATION

Given the remarkable versatility of ELECTRICOM II, particular attention should be given to the location of grommets, exterior panels, pedestals and any other items that might interfere with the raceway or the cables.

Under certain circumstances, grommets may need to be added to furniture. This can be done on-site by a professional installer or at the manufacturing facility according to your specifications. In the latter case, refer to the "Standard Specials" section on page 4 for the appropriate procedure, or contact Groupe Lacasse's Customer Service department.

SPECIFICATION EXAMPLES:

Morpheo

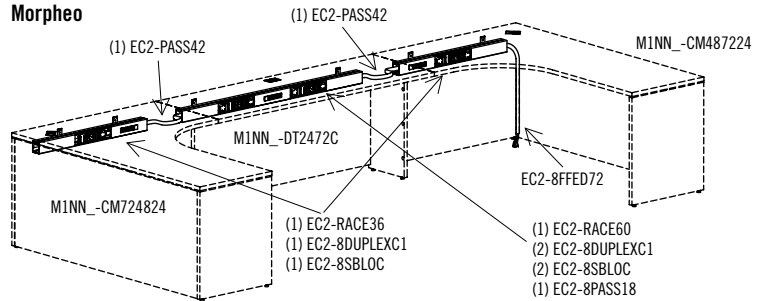

Quorum

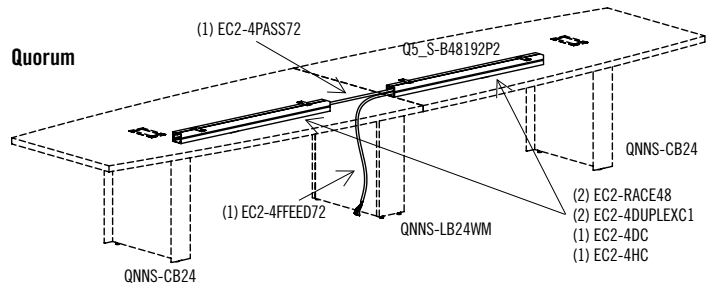

4-TRAC SYSTEM SPECIFICATIONS

4 – wires, 2 circuits, 20 AMP each
 13 – duplex receptacles per circuit
 26 – duplex 15 AMP per electrical entry

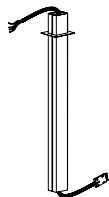
4-Trac ceiling feed

Silver anodized aluminum pole, 120" H (3000 mm) x 3" (75 mm) x 2 1/2" (63 mm). 132" metallic sheathed cable. Cover, surface support and ceiling plate included. Must be installed by an electrician.

Code	Price (\$)
EC2-4CPOLE120	805

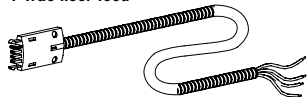
4-Trac floor feed

72" long cable. Must be installed by an electrician.

Code	Price (\$)
EC2-4FFFEED72	329

4-Trac connector cables

To connect duplex receptacles to each other.

Code	Price (\$)	Code	Price (\$)
EC2-4PASS12	166	EC2-4PASS48	216
EC2-4PASS18	175	EC2-4PASS54	226
EC2-4PASS24	185	EC2-4PASS60	237
EC2-4PASS30	192	EC2-4PASS66	244
EC2-4PASS36	201	EC2-4PASS72	252
EC2-4PASS42	211		

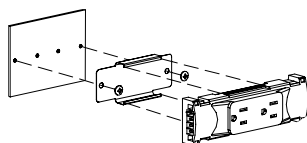
4-Trac duplex receptacle

2 outlets per duplex receptacle.

Code	Price (\$)
EC2-4DUPLEX__	175

Specify circuit 1 or 2.

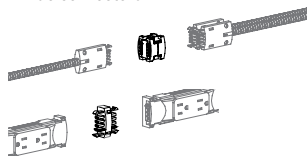
4-Trac connectors

Code	Price (\$)
------	------------

H connector. Allows up to 4 cables to be connected together.

EC2-4HC	109
---------	-----

Duplex receptacle connector. Allows the connection of 2 duplex receptacles.

EC2-4DC	101
---------	-----

8-TRAC SYSTEM SPECIFICATIONS

8 – wires, 4 circuits including 4 conductor cables, 2 neutral and 2 ground (1 isolated). 20 AMP.
 Maximum of 13 duplex receptacles per circuit, with a total of 52 receptacles available.

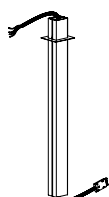
8-Trac ceiling feed

Silver anodized aluminum pole, 120" (3000 mm) high x 3" (75 mm) x 2 1/2" (63 mm). 132" metallic sheathed cable. Cover, surface support and ceiling plate included. Must be installed by an electrician.

Code	Price (\$)
EC2-8CPOLE120	873

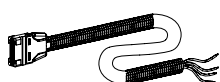
8-Trac floor feed

72" long cable. Must be installed by an electrician.

Code	Price (\$)
EC2-8FFFEED72	344

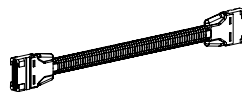
8-Trac connector cables

To connect duplex receptacles to each other.

Code	Price (\$)	Code	Price (\$)
EC2-8PASS12	204	EC2-8PASS48	252
EC2-8PASS18	211	EC2-8PASS54	260
EC2-8PASS24	216	EC2-8PASS60	266
EC2-8PASS30	226	EC2-8PASS66	276
EC2-8PASS36	237	EC2-8PASS72	287
EC2-8PASS42	244		

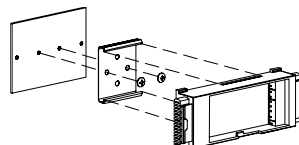
8-Trac blocks

Single block with required hardware to fix on the raceway. Can receive one duplex receptacle.

Code	Price (\$)
EC2-8SBLOC	175

Double block with required hardware to fix on the raceway. Can receive two duplex receptacles.

Code	Price (\$)
EC2-8DBLOC	216

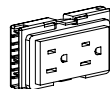
8-Trac duplex

2 outlets per duplex receptacle. 15 amp.

Code	Price (\$)
EC2-8DUPLEX__	136

Specify circuit 1, 2, 3 or 4.

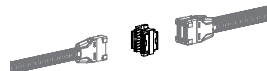
8-Trac connector

H connector. Allows up to 4 cables to be connected together.

Code	Price (\$)
EC2-8HC	136

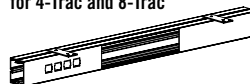
Electrical / communication raceways for 4-Trac and 8-Trac

Silver anodized aluminum raceway, covers, communication adaptors and 2 surface supports included.

Code	Length (in)	Length (mm)	Price (\$)
EC2-RACE60	60	1500	434
EC2-RACE48	48	1200	418
EC2-RACE36	36	900	404
EC2-RACE24	24	600	387
EC2-RACE18	18	450	361

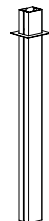
Pole

Silver anodized aluminum, 120" H (3000 mm) pole. Cover, surface support and ceiling cap included.

Code	Price (\$)
EC2-POLE120	629

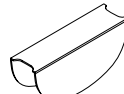
LCO Leg cap

To cover unused wire openings in a thermofused laminate leg panel. Package of 2. Anthracite Grey metal.

Code	Price (\$)
LGC-LCO	101