

Office Doctor Discount Office Furniture

www.OfficeDr.com 856-368-9085

Groupe Lacasse Half Price Sale On Now

Take Half Off the List Prices in this PDF

Call 856-368-9085 Now

Free Layout & Design Service

Think Smart Educational Series





FEBRUARY 2025

EDUCATIONAL FURNITURE PRICE LIST - USA

THINK SMART

THE LEARNING ENVIRONMENT SOLUTION

LACASSE

NICER FOR THE ENVIRONMENT

It's our corporate responsibility to contribute to the preservation of natural resources and to ensure that our operations have the least possible impact on the environment. We choose suppliers who support our efforts to reduce deforestation. The majority of our products are manufactured from particleboard, made from 100% post-industrial recycled materials. We recover the cuttings from all our activities and even sawdust for power cogeneration. What's more, we sort and recycle plastic, steel and aluminum.

Our Saint-Pie, QC facilities are certified ISO 9001 and ISO 14 001.

We're proud to say that all Lacasse products are GREENGUARD® Gold certified. Which means that North Americans can be sure that these products will not affect the air quality of their working environments. And other groups, like architects, designers and specifiers who use Lacasse products can benefit from their GREENGUARD® certification to earn points towards meeting LEED® standards.

For more information on Groupe Lacasse sustainable development practices, visit www.groupelacasse.com.



Think Smart has achieved GREENGUARD GOLD Certification.
GREENGUARD Certified products are certified to GREENGUARD standards for low chemical emissions into indoor air during product usage. For more information, visit ul.com/gg.

ENVIRONMENTAL TOOLS

A variety of informative tools which detail how Groupe Lacasse products help support green initiatives are available. All documents are routinely updated and placed on the Groupe Lacasse website in the **Environment** section. Please check this page regularly for the most up-to-date documents.

Available documents: the corporate **Sustainability Policy**, how our products support **LEED Credits** (these documents include information on the percentage of recycled material in each product) and a listing of Groupe Lacasse products that are **GREENGUARD Certified**.

GREENGUARD CERTIFICATES

The GREENGUARD certificates can be uploaded from www.groupelacasse.com by clicking on the **Documents** tab of the certified collections/product pages.

FURTHER INFORMATION

For more information on environmental and sustainable procedures in the manufacturing of our products, contact Communications@groupelacasse.com.

TABLE OF CONTENTS

ENVIRONMENTAL INITIATIVES	2	WALL-MOUNTED SYSTEM	16
GENERAL SPECIFICATIONS	3	SHELVINGS	18
THINK SMART EDUCATIONAL FURNITURE	6	CIRCULATION DESKS	18
DESKS	6	BENCHES	21
CARRELS	8	LOCKERS	21
TABLES	11	ACCESSORIES	22
COMPLEMENTARY FURNITURE	12	ELECTRIFICATION	22
STORAGE UNITS	14	TECHNICAL PERFORMANCES	23
MODULAR CABINETS	15		

THINK SMART

EDUCATIONAL FURNITURE

EDGEBOARDING

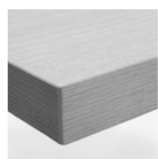

N EDGE

Furniture with 1" and 1½" (25 and 38 mm) thick tops.

Smooth, ¼" (1,5 mm) thick edge.

The **N** edge is **matched with the finish specified for the surface.**

DOOR INSERTS

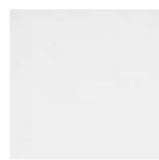

T – TRANSLUCENT

HANDLES



L – LINEAR



Q – SQUARE



V – ROUND

Exceptions: L handle is not compatible on furniture with aluminum framed translucent doors or on the metal doors of laptop carts.

Exceptions: The modular cabinets with single door are only available with Q and V handles.

LEGS



Q – SQUARE



V – ROUND

ACCENT COLORS



S – SILVER



A – ANTHRACITE GREY

The accent color applies to non-laminate components such as bases, handles, grommets, ventilation grids, laptop cart metal doors and wall cabinet hardware.

Exceptions: Power units, translucent doors and aluminum legs on benches are available in Silver anodized aluminum only.

Steel shelves are available painted Anthracite grey only.

CODIFICATION

SERIES	OPTIONS			
	THICKNESS	HANDLES	ACCENT COLORS	LEGS
E	1 Thermofused laminate 1"	N N/A	N N/A	Q Square
	2 High-pressure laminate 1"	L Linear	A Anthracite grey	V Round
	5 Thermofused laminate 1½"	Q Square	S Silver	
	6 High-pressure laminate 1½"	V Round		

GENERAL SPECIFICATIONS

WITH GROUPE LACASSE DESIGN AND MANUFACTURING CAPABILITIES, THERE IS VERY LITTLE THAT WE CANNOT DO WITH THERMOFUSED LAMINATES – AND WE BELIEVE THAT WE CAN QUOTE AND WIN MOST ARCHITECT AND DESIGNER SPECIFIC PROJECTS.

ALL STANDARD PRODUCTS MEET OR EXCEED ANSI/BIFMA REQUIREMENTS.

SURFACES

Work surfaces and tops are made of 1" (25 mm) or 1½" (38 mm) thick mar-resistant high-performance laminate (45 lbs/ft³) laminated on both faces, also called TFL.

High-pressure laminate work surfaces are available, also called HPL, for certain units, adding ¼" (1,6 mm) to the overall thickness of the work surface.

Side panels are 1" (25 mm) thick.

EDGEBOARDING

Work surfaces are finished with a ¼" (1,5 mm) ABS smooth edgebanding.

CONSTRUCTION

In a majority of cases, products are assembled with metal-to-metal hardware to facilitate the replacement of parts in case of damage.

DRAWERS AND DOORS

All drawers built for trouble-free performance.

- Black full extension ball bearing suspensions.
- 100 lbs (45 kg) load capacity for box and file drawers.
- 150 lbs (68 kg) load capacity for lateral file drawers.
- Five sided drawer construction including bottom in ¼" (11 mm) black particleboard. Reinforced rod on 36" (914 mm) wide drawers.
- PVC top rails for lateral file folders.
- Standard interlock system where required.
- 135° hinges on doors.
- 270° hinges are available upon request (contact Groupe Lacasse Quotations Department).

LOCKS

Cam lock is available on drawers and doors and will match the specified accent color; Black or Silver. Key-alike option is available upon request (contact Groupe Lacasse Customer Service).

LEVELERS

Levelers allow up to 1/4" (32 mm) height adjustment unless otherwise specified.

CASTERS

Mobile units have 3" (75 mm) diameter heavy-duty casters made of non-marking synthetic rubber. Load capacity of 176 lbs (80 kg) per caster.

PROTECTIVE RUBBER BUMPER

Grey rubber bumpers are available for mobile units. Bumpers are sold separately; please refer to the Accessories section, p. 23.

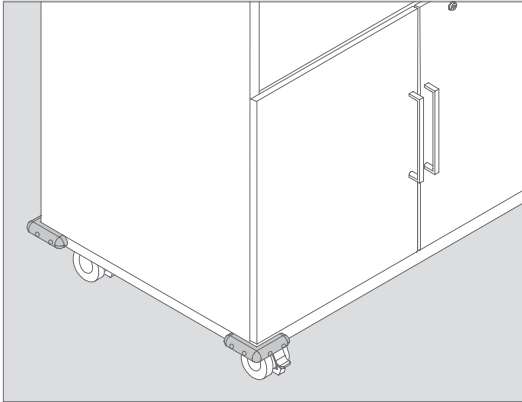

SHELVES

- 1" (25 mm) thick thermofused laminate shelves have a hidden anti-tip device when there is no door in front of them.
- Metal shelves are made of 18 gauge steel with a load capacity of 150 lbs (68 kg).

HANDLES

Three choices of handles available in Silver or Anthracite grey finish: Linear (L) thermoplastic (exceptions in some cases) polymer handle, Square (Q) or Round (V) metal pulls.

The LGC-PULL17 handle for mobile units only is sold separately; please refer to p. 16.

LEGS

Two choices of legs available in Silver or Anthracite grey finish: Square (Q) or Round (V) metal legs.

BENCH CUSHIONS

2" (51 mm) thick foam cushion installs on bench with Velcro (included). Cushions comply with Cal. 117 requirements.

TECHNOLOGY INTEGRATION

- Matching Anthracite grey or Silver grommets included on most furniture units.
- Certain teachers' desks include CPU storage units and ventilation grids to accommodate a variety of electronic devices.
- Wire management raceways included on computer carrels, laptop and CPU tables.
- For optional electrical/communication modules; please refer to Accessories section, p. 23.

DIMENSIONS

Metric dimensions are exact; imperial dimensions are nominal (unless otherwise specified).

OTHER FINISHES (SPECIAL)

Other finishes (i.e., non standard) may be ordered at an upcharge. Minimum quantity may be required. Please check with our Quotations Department. Delivery may vary depending on the choice of finish or type of material.

MODULAR CABINETRY

All modular cabinetry must be attached to a wall to ensure stability and security.

WALL-MOUNTED LAMINATE HANGING SYSTEM

The wall-mounted laminate panel should be installed by a professional. Appropriate hardware must be used to ensure a good and secure installation of the laminate panel to the wall. Panel mount hardware is not included and may vary depending on wall type. The laminate panel should be equal or longer than the length of all of the hanging component(s); i.e., white board, cabinet, etc.

CABINETS AND ACCESSORIES FOR WALL-MOUNTED HANGING SYSTEM

Hanging components such as white boards, cabinets, bookcases must be securely attached to the wall-mounted laminate panel with the supplied mounting hardware.

THE SYSTEM IS VERY FLEXIBLE AND ALLOWS MANY CONFIGURATIONS, PLANS BELOW ILLUSTRATE THE RECOMMENDED POSITION OF THE STORAGE UNITS.

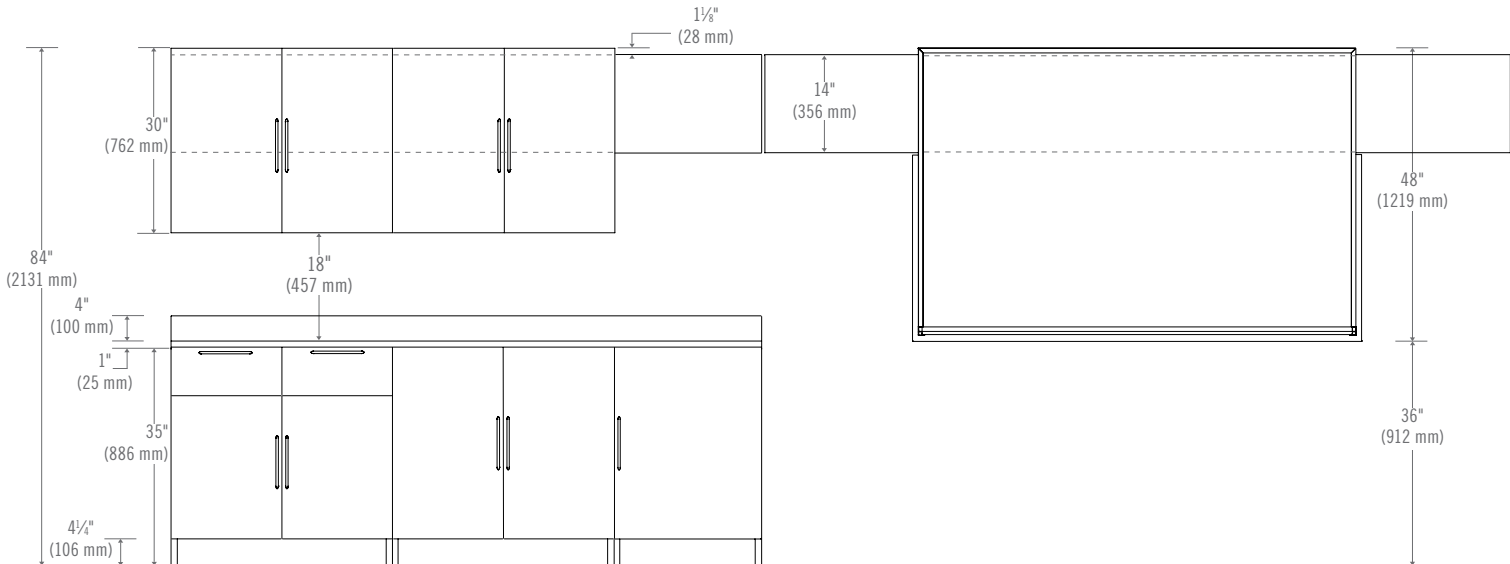

POWER BAR (LGC-POWERBAR)

To be used with laptop carts; installs on the back portion of the cart. Maximum input current; 15 AMP, 10 outlets. Surge and overload protection.

A separate wall circuit is recommended for each surge and overload-protected 10-outlet electrical unit.

When the units are plugged into wall outlets, make sure not to exceed circuit capacity (15 to 20 AMP per circuit).

Using a timer to recharge laptops is recommended or using different wall outlets to prevent tripping breaker when all power bar outlets are in use.

UL Recognized - UL 1363
RoHS Compliancy.

Power bar is sold separately; please refer to p. 13.

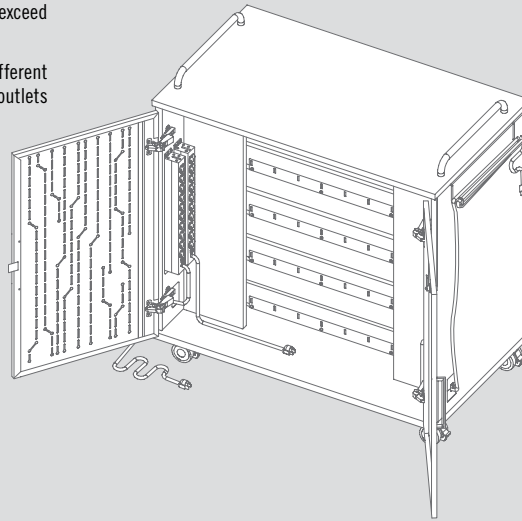

ELECTRICITY

4-Trac System is compatible with laptop and CPU tables, as well as all types of carrels.

4-TRAC SYSTEM FEATURES:

- 4-wires, 2 circuits, 20 AMP each.
- 13 duplex receptacles per circuit. Maximum of 26 duplex receptacles of 15 AMP per power infeed.
- Easy to specify, install and reconfigure.
- UL listed as a Manufactured Wiring System.
- RoHS Compliancy available upon request; Cradle to Cradle.
- Will work in all locations except for Chicago. Manufactured Wiring Systems are not permitted in Chicago.
- Chicago code compliancy and many other options (8-wire system, etc.) are available upon request; contact Groupe Lacasse Quotations Department.

HOW TO SPECIFY

EXAMPLE USING A CONFIGURATION OF LAPTOP TABLES (E_N_RLP2460J)

STEP 1

Determine the number of users in function of the length of the surface and their electrical requirements (1 or 2 duplex receptacles per workstation are usually sufficient).

LGC-DUPLEXC_

STEP 2

Determine whether 1 or 2 circuits are needed, accordingly to the quantity of duplex receptacles.

STEP 3

Determine pass cable lengths in function of duplex receptacle positioning and surface lengths.

LGC-PASS_ _

STEP 4

Determine electrical feed cable length, between the duplex receptacle and wall power source. The electrical installation must be made by a professional electrician.

LGC-FFEED_ _

STEP 1 & 2

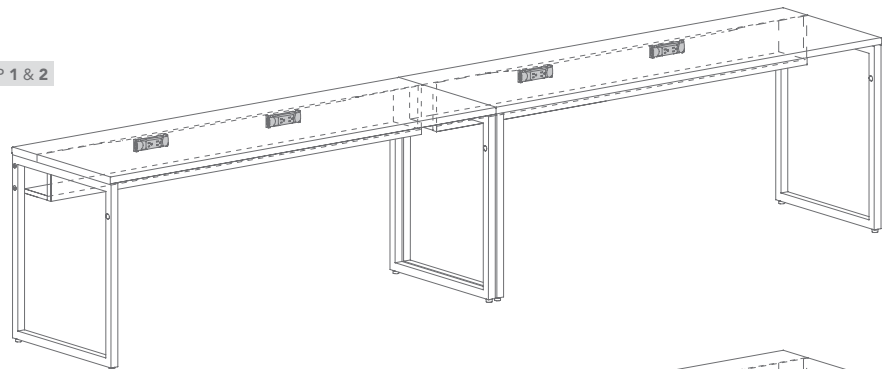

STEP 3

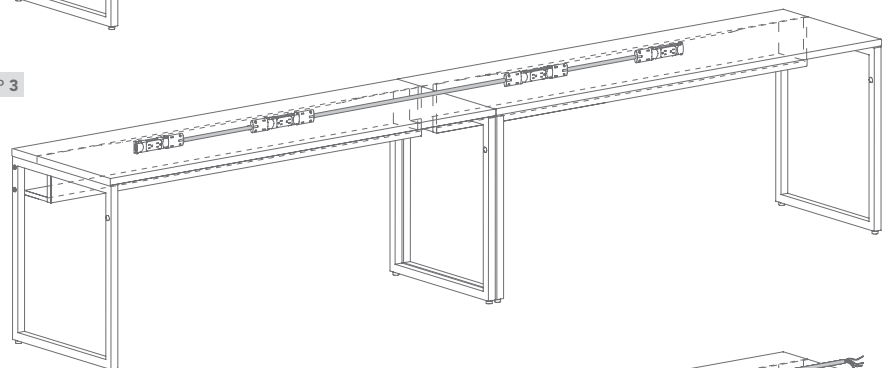

STEP 4

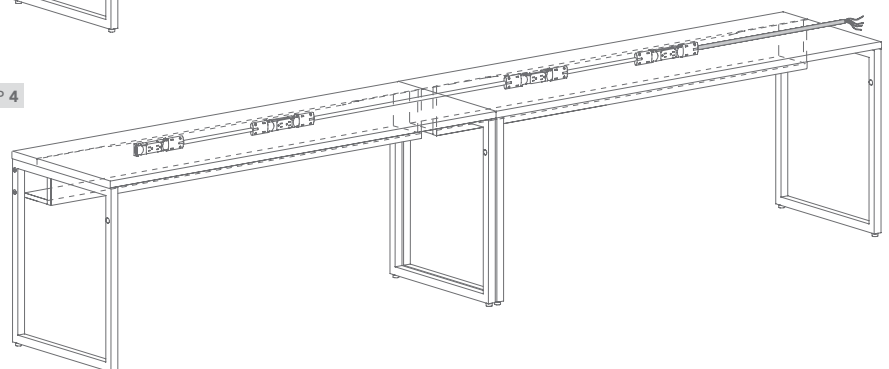

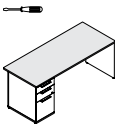
	W x D x H (")	W x D x H (mm)	Code	All Laminate (\$)	HPL Surfaces (\$)
TEACHER'S DESKS					
Left single pedestal desks	<i>1 pedestal on left with lock. 2 box drawers and 1 file drawer with suspension bar. Lock controls all drawers. Pencil tray. Recessed half-height modesty panel.</i>				
	72 x 30 x 29	1800 x 750 x 735	E___-UF3072S	2,287	2,565
	60 x 30 x 29	1500 x 750 x 735	E___-UF3060S	2,247	2,471
	48 x 30 x 29	1200 x 750 x 735	E___-UF3048S	2,203	2,388
	Specify the surface type (1, 2). Specify the handle code (L, Q, V). Specify the accent color (A, S).				

Packaged in 2 boxes.

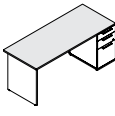
Right single pedestal desks	<i>1 pedestal on right with lock. 2 box drawers and 1 file drawer with suspension bar. Lock controls all drawers. Pencil tray. Recessed half-height modesty panel.</i>				
	72 x 30 x 29	1800 x 750 x 735	E___-S3072UF	2,287	2,565
	60 x 30 x 29	1500 x 750 x 735	E___-S3060UF	2,247	2,471
	48 x 30 x 29	1200 x 750 x 735	E___-S3048UF	2,203	2,388
	Specify the surface type (1, 2). Specify the handle code (L, Q, V). Specify the accent color (A, S).				

Packaged in 2 boxes.

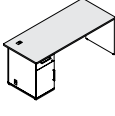
Left single pedestal desks	<i>1 pedestal on left with lock. 1 box drawer and 1 CPU storage with door and ventilation grid. Lock controls drawer and CPU storage door. Grommet on desk surface and on sides of CPU storage. Pencil tray. Recessed half-height modesty panel. CPU storage space: 14" W x 24 1/4" D x 21 1/2" H (356 x 617 x 544 mm).</i>				
	72 x 30 x 29	1800 x 750 x 735	E___-UC3072S	1,995	2,262
	60 x 30 x 29	1500 x 750 x 735	E___-UC3060S	1,952	2,179
	48 x 30 x 29	1200 x 750 x 735	E___-UC3048S	1,912	2,088
	Specify the surface type (1, 2). Specify the handle code (L, Q, V). Specify the accent color (A, S).				

Packaged in 2 boxes.

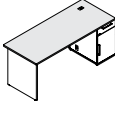
Right single pedestal desks	<i>1 pedestal on right with lock. 1 box drawer and 1 CPU storage with door and ventilation grid. Lock controls drawer and CPU storage door. Grommet on desk surface and on sides of CPU storage. Pencil tray. Recessed half-height modesty panel. CPU storage space: 14" W x 24 1/4" D x 21 1/2" H (356 x 617 x 544 mm).</i>				
	72 x 30 x 29	1800 x 750 x 735	E___-S3072UC	1,995	2,262
	60 x 30 x 29	1500 x 750 x 735	E___-S3060UC	1,952	2,179
	48 x 30 x 29	1200 x 750 x 735	E___-S3048UC	1,912	2,088
	Specify the surface type (1, 2). Specify the handle code (L, Q, V). Specify the accent color (A, S).				

Packaged in 2 boxes.

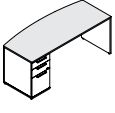
Left single pedestal bow front desks	<i>1 pedestal on left with lock. 2 box drawers and 1 file drawer with suspension bar. Lock controls all drawers. Pencil tray. Recessed half-height modesty panel.</i>				
	72 x 30 x 29	1800 x 750 x 735	E___-UF3072SA	2,355	2,680
	60 x 30 x 29	1500 x 750 x 735	E___-UF3060SA	2,313	2,580
	48 x 30 x 29	1200 x 750 x 735	E___-UF3048SA	2,262	2,482
	Specify the surface type (1, 2). Specify the handle code (L, Q, V). Specify the accent color (A, S).				

Packaged in 2 boxes.

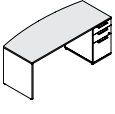
Right single pedestal bow front desks	<i>1 pedestal on right with lock. 2 box drawers and 1 file drawer with suspension bar. Lock controls all drawers. Pencil tray. Recessed half-height modesty panel.</i>				
	72 x 30 x 29	1800 x 750 x 735	E___-S3072UFA	2,355	2,680
	60 x 30 x 29	1500 x 750 x 735	E___-S3060UFA	2,313	2,580
	48 x 30 x 29	1200 x 750 x 735	E___-S3048UFA	2,262	2,482
	Specify the surface type (1, 2). Specify the handle code (L, Q, V). Specify the accent color (A, S).				

Packaged in 2 boxes.

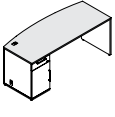
Left single pedestal bow front desks	<i>1 pedestal on left with lock. 1 box drawer and 1 CPU storage with door and ventilation grid. Lock controls drawer and CPU storage door. Grommet on desk surface and on sides of CPU storage. Pencil tray. Recessed half-height modesty panel. CPU storage space: 14" W x 24 1/4" D x 21 1/2" H (356 x 617 x 544 mm).</i>				
	72 x 30 x 29	1800 x 750 x 735	E___-UC3072SA	2,028	2,355
	60 x 30 x 29	1500 x 750 x 735	E___-UC3060SA	1,980	2,247
	48 x 30 x 29	1200 x 750 x 735	E___-UC3048SA	1,928	2,144
	Specify the surface type (1, 2). Specify the handle code (L, Q, V). Specify the accent color (A, S).				

Packaged in 2 boxes.

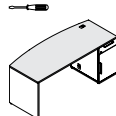
	W x D x H (")	W x D x H (mm)	Code	All Laminate (\$)	HPL Surfaces (\$)
Right single pedestal bow front desks					
	<i>1 pedestal on right with lock. 1 box drawer and 1 CPU storage with door and ventilation grid. Lock controls drawer and CPU storage door. Grommet on desk surface and on sides of CPU storage. Pencil tray. Recessed half-height modesty panel. CPU storage space: 14" W x 24 1/4" D x 21 1/2" H (356 x 617 x 544 mm).</i>				
	72 x 30 x 29	1800 x 750 x 735	E___-S3072UCA	2,028	2,355
	60 x 30 x 29	1500 x 750 x 735	E___-S3060UCA	1,980	2,247
	48 x 30 x 29	1200 x 750 x 735	E___-S3048UCA	1,928	2,144
	Specify the surface type (1, 2). Specify the handle code (L, Q, V). Specify the accent color (A, S).				

Packaged in 2 boxes.

D-SHAPED TEACHER'S DESKS

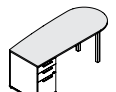
Left single pedestal D-shaped desks	<i>1 pedestal on left with lock. 2 box drawers and 1 file drawer with suspension bar. Lock controls all drawers. Pencil tray. Recessed half-height modesty panel. 2 steel legs.</i>				
	72 x 30 x 29	1800 x 750 x 735	E___-UF3072D	2,632	2,898
	60 x 30 x 29	1500 x 750 x 735	E___-UF3060D	2,597	2,825
	Specify the surface type (1, 2). Specify the handle code (L, Q, V). Specify the accent color (A, S).				

Specify the leg selection at the end of the product code (Q, V).
Packaged in 3 boxes.

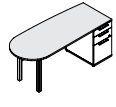
Right single pedestal D-shaped desks	<i>1 pedestal on right with lock. 2 box drawers and 1 file drawer with suspension bar. Lock controls all drawers. Pencil tray. Recessed half-height modesty panel. 2 steel legs.</i>				
	72 x 30 x 29	1800 x 750 x 735	E___-3072UFD	2,632	2,898
	60 x 30 x 29	1500 x 750 x 735	E___-3060UFD	2,597	2,825
	Specify the surface type (1, 2). Specify the handle code (L, Q, V). Specify the accent color (A, S).				

Specify the leg selection at the end of the product code (Q, V).
Packaged in 3 boxes.

Left single pedestal D-shaped mobile desks	<i>1 pedestal on left with lock. 2 box drawers and 1 file drawer with suspension bar. Lock controls all drawers. Pencil tray. Recessed half-height modesty panel. 2 steel legs. 6 swivel casters, 4 with brakes.</i>				
	72 x 30 x 29	1800 x 750 x 735	E___-MUF3072D	2,732	3,000
	60 x 30 x 29	1500 x 750 x 735	E___-MUF3060D	2,698	2,924
	Specify the surface type (1, 2). Specify the handle code (L, Q, V). Specify the accent color (A, S).				

Specify the leg selection at the end of the product code (Q, V).
Packaged in 3 boxes.

Right single pedestal D-shaped mobile desks	<i>1 pedestal on right with lock. 2 box drawers and 1 file drawer with suspension bar. Lock controls all drawers. Pencil tray. Recessed half-height modesty panel. 2 steel legs. 6 swivel casters, 4 with brakes.</i>				
	72 x 30 x 29	1800 x 750 x 735	E___-M3072UFD	2,732	3,000
	60 x 30 x 29	1500 x 750 x 735	E___-M3060UFD	2,698	2,924
	Specify the surface type (1, 2). Specify the handle code (L, Q, V). Specify the accent color (A, S).				

Specify the leg selection at the end of the product code (Q, V).
Packaged in 3 boxes.

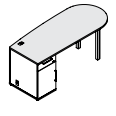
Left single pedestal D-shaped desks	<i>1 pedestal on left with lock. 1 box drawer and 1 CPU storage with door and ventilation grid. Lock controls drawer and CPU storage door. Grommet on desk surface and on sides of CPU storage. Pencil tray. Recessed half-height modesty panel. CPU storage space: 14" W x 24 1/4" D x 21 1/2" H (356 x 617 x 544 mm).</i>				
	72 x 30 x 29	1800 x 750 x 735	E___-UC3072D	2,565	2,833
	60 x 30 x 29	1500 x 750 x 735	E___-UC3060D	2,530	2,757
	Specify the surface type (1, 2). Specify the handle code (L, Q, V). Specify the accent color (A, S).				

Specify the leg selection at the end of the product code (Q, V).
Packaged in 3 boxes.

W x D x H (")	W x D x H (mm)	Code	All Laminate (\$)	HPL Surfaces (\$)
72 x 30 x 29	1800 x 750 x 735	E___-3072UCD	2,565	2,833
60 x 30 x 29	1500 x 750 x 735	E___-3060UCD	2,530	2,757

Right single pedestal D-shaped desks



Specify the leg selection at the end of the product code (Q, V).
Packaged in 3 boxes.

1 pedestal on right with lock. 1 box drawer and 1 CPU storage with door and ventilation grid. Lock controls drawer and CPU storage door. Grommet on desk surface and on sides of CPU storage. Pencil tray. Recessed half-height modesty panel. 2 steel legs. CPU storage space: 14" W x 24 1/4" D x 21 1/2" H (356 x 617 x 544 mm).

Specify the surface type (1, 2). Specify the handle code (L, Q, V).
Specify the accent color (A, S).

Left single pedestal D-shaped mobile desks



Specify the leg selection at the end of the product code (Q, V).
Packaged in 3 boxes.

1 pedestal on left with lock. 1 box drawer and 1 CPU storage with door and ventilation grid. Lock controls drawer and CPU storage door. Swivel wire supports. Grommet on desk surface and on sides of CPU storage. Pencil tray. Recessed half-height modesty panel. 2 steel legs. 6 swivel casters, 4 with brakes. CPU storage space: 14" W x 24 1/4" D x 18 3/8" H (356 x 617 x 467 mm).

Specify the surface type (1, 2). Specify the handle code (L, Q, V).
Specify the accent color (A, S).

Right single pedestal D-shaped mobile desks



Specify the leg selection at the end of the product code (Q, V).
Packaged in 3 boxes.

1 pedestal on right with lock. 1 box drawer and 1 CPU storage with door and ventilation grid. Lock controls drawer and CPU storage door. Swivel wire supports. Grommet on desk surface and on sides of CPU storage. Pencil tray. Recessed half-height modesty panel. 2 steel legs. 6 swivel casters, 4 with brakes. CPU storage space: 14" W x 24 1/4" D x 18 3/8" H (356 x 617 x 467 mm).

Specify the surface type (1, 2). Specify the handle code (L, Q, V).
Specify the accent color (A, S).

P-SHAPED TEACHER'S DESKS

Left single pedestal P-shaped desks



Specify the leg selection at the end of the product code (Q, V).
Packaged in 3 boxes.

1 pedestal on left with lock. 2 box drawers and 1 file drawer with suspension bar. Lock controls all drawers. Pencil tray. Recessed half-height modesty panel. 2 steel legs. CPU storage space: 14" W x 24 1/4" D x 18 3/8" H (356 x 617 x 467 mm).

Specify the surface type (1, 2). Specify the handle code (L, Q, V).
Specify the accent color (A, S).

Right single pedestal P-shaped desks



Specify the leg selection at the end of the product code (Q, V).
Packaged in 3 boxes.

1 pedestal on right with lock. 2 box drawers and 1 file drawer with suspension bar. Lock controls all drawers. Pencil tray. Recessed half-height modesty panel. 2 steel legs. CPU storage space: 14" W x 24 1/4" D x 18 3/8" H (356 x 617 x 467 mm).

Specify the surface type (1, 2). Specify the handle code (L, Q, V).
Specify the accent color (A, S).

Left single pedestal P-shaped mobile desks



Specify the leg selection at the end of the product code (Q, V).
Packaged in 3 boxes.

1 pedestal on left with lock. 2 box drawers and 1 file drawer with suspension bar. Lock controls all drawers. Pencil tray. Recessed half-height modesty panel. 2 steel legs. 6 swivel casters, 4 with brakes.

72 x 36 x 29	1800 x 900 x 735	E___-MUF3672P	2,859	3,186
66 x 36 x 29	1650 x 900 x 735	E___-MUF3666P	2,841	3,111

Specify the surface type (1, 2). Specify the handle code (L, Q, V).
Specify the accent color (A, S).

Right single pedestal P-shaped mobile desks

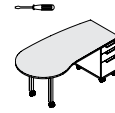

Specify the leg selection at the end of the product code (Q, V).
Packaged in 3 boxes.

1 pedestal on right with lock. 2 box drawers and 1 file drawer with suspension bar. Lock controls all drawers. Pencil tray. Recessed half-height modesty panel. 2 steel legs. 6 swivel casters, 4 with brakes.

72 x 36 x 29	1800 x 900 x 735	E___-M3672UFP	2,859	3,186
66 x 36 x 29	1650 x 900 x 735	E___-M3666UFP	2,841	3,111

Specify the surface type (1, 2). Specify the handle code (L, Q, V).
Specify the accent color (A, S).

Left single pedestal P-shaped desks

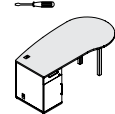

Specify the leg selection at the end of the product code (Q, V).
Packaged in 3 boxes.

1 pedestal on left with lock. 1 box drawer and 1 CPU storage with door and ventilation grid. Lock controls drawer and CPU storage door. Grommet on desk surface and on sides of CPU storage. Pencil tray. Recessed half-height modesty panel. 2 steel legs. CPU storage space: 14" W x 24 1/4" D x 21 1/2" H (356 x 617 x 544 mm).

72 x 36 x 29	1800 x 900 x 735	E___-UC3672P	2,298	2,624
66 x 36 x 29	1650 x 900 x 735	E___-UC3666P	2,262	2,530

Specify the surface type (1, 2). Specify the handle code (L, Q, V).
Specify the accent color (A, S).

Right single pedestal P-shaped desks

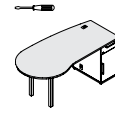

Specify the leg selection at the end of the product code (Q, V).
Packaged in 3 boxes.

1 pedestal on right with lock. 1 box drawer and 1 CPU storage with door and ventilation grid. Lock controls drawer and CPU storage door. Grommet on desk surface and on sides of CPU storage. Pencil tray. Recessed half-height modesty panel. 2 steel legs. CPU storage space: 14" W x 24 1/4" D x 21 1/2" H (356 x 617 x 544 mm).

72 x 36 x 29	1800 x 900 x 735	E___-3672UCP	2,298	2,624
66 x 36 x 29	1650 x 900 x 735	E___-3666UCP	2,262	2,530

Specify the surface type (1, 2). Specify the handle code (L, Q, V).
Specify the accent color (A, S).

Left single pedestal P-shaped mobile desks

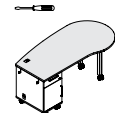

Specify the leg selection at the end of the product code (Q, V).
Packaged in 3 boxes.

1 pedestal on left with lock. 1 box drawer and 1 CPU storage with door and ventilation grid. Lock controls drawer and CPU storage door. Swivel wire supports. Grommet on desk surface and on sides of CPU storage. Pencil tray. Recessed half-height modesty panel. 2 steel legs. 6 swivel casters, 4 with brakes. CPU storage space: 14" W x 24 1/4" D x 18 3/8" H (356 x 617 x 467 mm).

72 x 36 x 29	1800 x 900 x 735	E___-MUC3672P	2,397	2,725
66 x 36 x 29	1650 x 900 x 735	E___-MUC3666P	2,362	2,632

Specify the surface type (1, 2). Specify the handle code (L, Q, V).
Specify the accent color (A, S).

Right single pedestal P-shaped mobile desks

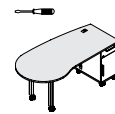

Specify the leg selection at the end of the product code (Q, V).
Packaged in 3 boxes.

1 pedestal on right with lock. 1 box drawer and 1 CPU storage with door and ventilation grid. Lock controls drawer and CPU storage door. Swivel wire supports. Grommet on desk surface and on sides of CPU storage. Pencil tray. Recessed half-height modesty panel. 2 steel legs. 6 swivel casters, 4 with brakes. CPU storage space: 14" W x 24 1/4" D x 18 3/8" H (356 x 617 x 467 mm).

72 x 36 x 29	1800 x 900 x 735	E___-M3672UCP	2,397	2,725
66 x 36 x 29	1650 x 900 x 735	E___-M3666UCP	2,362	2,632

Specify the surface type (1, 2). Specify the handle code (L, Q, V).
Specify the accent color (A, S).

LECTERN-DESKS

Left lectern-desks single pedestal

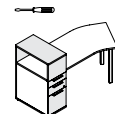

Specify the leg selection at the end of the product code (Q, V).
Packaged in 3 boxes.

11 7/8" H (300 mm) storage opening under lectern surface. Pedestal on left with lock. 2 box drawers and 1 file drawer with suspension bar. Lock controls all drawers. Pencil tray. Recessed half-height modesty panel. 2 steel legs.

72 x 30 x 42	1800 x 750 x 1063	E___-LUF3072	2,932	3,261
66 x 30 x 42	1650 x 750 x 1063	E___-LUF3066	2,898	3,126

Specify the surface type (1, 2). Specify the handle code (L, Q, V).
Specify the accent color (A, S).

	W x D x H (*)	W x D x H (mm)	Code	All Laminate (\$)	HPL Surfaces (\$)
Right lectern-desks single pedestal	<i>11 7/8" H (300 mm) storage opening under lectern surface. Pedestal on right with lock. 2 box drawers and 1 file drawer with suspension bar. Lock controls all drawers. Pencil tray. Recessed half-height modesty panel. 2 steel legs.</i>				
	72 x 30 x 42	1800 x 750 x 1063	E___-3072LUF_	2,932	3,261
	66 x 30 x 42	1650 x 750 x 1063	E___-3066LUF_	2,898	3,126

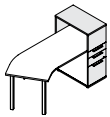

Specify the leg selection at the end of the product code (Q, V).
Packaged in 3 boxes.

	W x D x H (*)	W x D x H (mm)	Code	All Laminate (\$)	HPL Surfaces (\$)
Left lectern-desks single pedestal, mobile	<i>11 7/8" H (300 mm) storage opening under lectern surface. Pedestal on left with lock. 2 box drawers and 1 file drawer with suspension bar. Lock controls all drawers. Pencil tray. Recessed half-height modesty panel. 2 steel legs. 6 swivel casters, 4 with brakes.</i>				
	72 x 30 x 42	1800 x 750 x 1063	E___-MLUF3072_	3,035	3,362
	66 x 30 x 42	1650 x 750 x 1063	E___-MLUF3066_	3,000	3,226



Specify the leg selection at the end of the product code (Q, V).
Packaged in 3 boxes.

	W x D x H (*)	W x D x H (mm)	Code	All Laminate (\$)	HPL Surfaces (\$)
Right lectern-desks single pedestal, mobile	<i>11 7/8" H (300 mm) storage opening under lectern surface. Pedestal on right with lock. 2 box drawers and 1 file drawer with suspension bar. Lock controls all drawers. Pencil tray. Recessed half-height modesty panel. 2 steel legs. 6 swivel casters, 4 with brakes.</i>				
	72 x 30 x 42	1800 x 750 x 1063	E___-M3072LUF_	3,035	3,362
	66 x 30 x 42	1650 x 750 x 1063	E___-M3066LUF_	3,000	3,226



Specify the leg selection at the end of the product code (Q, V).
Packaged in 3 boxes.

	W x D x H (*)	W x D x H (mm)	Code	All Laminate (\$)	HPL Surfaces (\$)
Left lectern-desks single pedestal	<i>11 7/8" H (300 mm) storage opening under lectern surface. 1 pedestal on left with lock. 1 box drawer and 1 CPU storage with door and ventilation grid. Lock controls drawer and CPU storage door. Grommet on lectern surface, desk surface and on sides of CPU storage. Pencil tray. Recessed half-height modesty panel. 2 steel legs. CPU storage space: 14" W x 24 1/4" D x 21 1/2" H (356 x 617 x 544 mm).</i>				
	72 x 30 x 42	1800 x 750 x 1063	E___-LUC3072_	2,674	3,043
	66 x 30 x 42	1650 x 750 x 1063	E___-LUC3066_	2,641	2,877

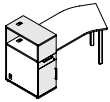

Specify the leg selection at the end of the product code (Q, V).
Packaged in 3 boxes.

	W x D x H (*)	W x D x H (mm)	Code	All Laminate (\$)	HPL Surfaces (\$)
Right lectern-desks single pedestal	<i>11 7/8" H (300 mm) storage opening under lectern surface. 1 pedestal on right with lock. Storage with door and ventilation grid. Lock controls drawer and CPU storage door. Grommet on lectern surface, desk surface and on sides of CPU storage. Pencil tray. Recessed half-height modesty panel. 2 steel legs. CPU storage space: 14" W x 24 1/4" D x 21 1/2" H (356 x 617 x 544 mm).</i>				
	72 x 30 x 42	1800 x 750 x 1063	E___-3072LUC_	2,674	3,043
	66 x 30 x 42	1650 x 750 x 1063	E___-3066LUC_	2,641	2,877

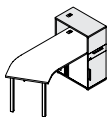

Specify the leg selection at the end of the product code (Q, V).
Packaged in 3 boxes.

	W x D x H (*)	W x D x H (mm)	Code	All Laminate (\$)	HPL Surfaces (\$)
Left lectern-desks single pedestal, mobile	<i>11 7/8" H (300 mm) storage opening under lectern surface. 1 pedestal on left with lock. 1 box drawer and 1 CPU storage with door and ventilation grid. Lock controls drawer and CPU storage door. Swivel wire supports. Grommet on lectern surface, desk surface and on sides of CPU storage. Pencil tray. Recessed half-height modesty panel. 2 steel legs. 6 swivel casters, 4 with brakes. CPU storage space: 14" W x 24 1/4" D x 18 3/8" H (356 x 617 x 467 mm).</i>				
	72 x 30 x 42	1800 x 750 x 1063	E___-MLUC3072_	2,775	3,142
	66 x 30 x 42	1650 x 750 x 1063	E___-MLUC3066_	2,740	2,974

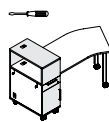

Specify the leg selection at the end of the product code (Q, V).
Packaged in 3 boxes.

	W x D x H (*)	W x D x H (mm)	Code	All Laminate (\$)	HPL Surfaces (\$)
Right lectern-desks single pedestal, mobile	<i>11 7/8" H (300 mm) storage opening under lectern surface. 1 pedestal on right with lock. 1 box drawer and 1 CPU storage with door and ventilation grid. Lock controls drawer and CPU storage door. Swivel wire supports. Grommet on lectern surface, desk surface and on sides of CPU storage. Pencil tray. Recessed half-height modesty panel. 2 steel legs. 6 swivel casters, 4 with brakes. CPU storage space: 14" W x 24 1/4" D x 18 3/8" H (356 x 617 x 467 mm).</i>				
	72 x 30 x 42	1800 x 750 x 1063	E___-M3072LUC_	2,775	3,142
	66 x 30 x 42	1650 x 750 x 1063	E___-M3066LUC_	2,740	2,974

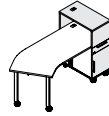

Specify the leg selection at the end of the product code (Q, V).
Packaged in 3 boxes.

CARRELS – 29" H WORK SURFACE

	W x D x H (*)	W x D x H (mm)	Code	All Laminate (\$)	HPL Surfaces (\$)
Individual single-sided carrels, 33" H	<i>Wire opening on top. 3/4 height modesty panel. Levelers with 1 1/2" (38 mm) height adjustment.</i>				
	Starter				
	37 x 34 1/2 x 33	925 x 869 x 834	E_NN-CS343733	963	1,089
Add-on					
<i>Wire access on side panel.</i>					
	36 x 34 1/2 x 33	900 x 869 x 834	E_NN-CA343633	782	905

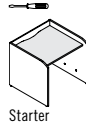

	W x D x H (*)	W x D x H (mm)	Code	All Laminate (\$)	HPL Surfaces (\$)
Shared single-sided carrels, 33" H	<i>Wire opening on top. 3/4 height modesty panel. Levelers with 1 1/2" (38 mm) height adjustment.</i>				
	Starter				
	73 x 34 1/2 x 33	1825 x 869 x 834	E_NN-CS347333	1,229	1,483
Add-on					
<i>Wire access on side panel.</i>					
	72 x 34 1/2 x 33	1800 x 869 x 834	E_NN-CA347233	1,048	1,299

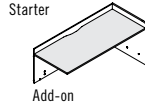
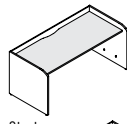

	W x D x H (*)	W x D x H (mm)	Code	All Laminate (\$)	HPL Surfaces (\$)
Individual single-sided carrels, 53" H	<i>Wire opening on top. 3/4 height modesty panel. Levelers with 1 1/2" (38 mm) height adjustment. 8" (200 mm) deep fixed accessory shelf. Clearance 15 5/8" H (390 mm).</i>				
	Starter				
	37 x 34 1/2 x 53	925 x 869 x 1342	E_NN-CS343753	1,241	1,370
Add-on					
<i>Wire access on side panel.</i>					
	36 x 34 1/2 x 53	900 x 869 x 1342	E_NN-CA343653	1,006	1,132

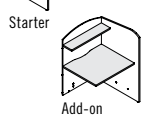
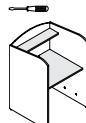

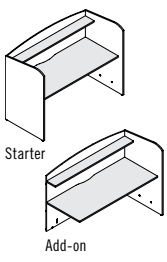
	W x D x H (")	W x D x H (mm)	Code	All Laminate (\$)	HPL Surfaces (\$)
Shared single-sided carrels, 53" H 	<i>Wire opening on top. 3/4 height modesty panel. Levelers with 1 1/2" (38 mm) height adjustment. 8" (200 mm) deep fixed accessory shelf. Clearance 15 3/8" H (390 mm).</i>				
	Starter				
	73 x 34 1/2 x 53	1825 x 869 x 1342	E_NN-CS347353	1,648	1,912
Add-on <i>Wire access on side panel.</i>	Starter				
	72 x 34 1/2 x 53	1800 x 869 x 1342	E_NN-CA347253	1,409	1,669
Specify the surface type (1, 2).					

Packaged in 2 boxes.

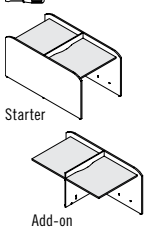
	W x D x H (")	W x D x H (mm)	Code	All Laminate (\$)	HPL Surfaces (\$)
Individual double-sided carrels, 33" H 	<i>Wire opening on top. 3/4 height modesty panel. Levelers with 1 1/2" (38 mm) height adjustment.</i>				
	Starter				
	37 x 67 1/2 x 33	925 x 1716 x 834	E_NN-CS673733	1,388	1,526
Add-on <i>Wire access on side panel.</i>	Starter				
	36 x 67 1/2 x 33	900 x 1716 x 834	E_NN-CA673633	1,048	1,172
Specify the surface type (1, 2).					

Starter:
Packaged in 2 boxes.

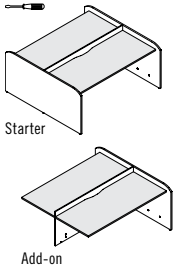
	W x D x H (")	W x D x H (mm)	Code	All Laminate (\$)	HPL Surfaces (\$)
Shared double-sided carrels, 33" H 	<i>Wire opening on top. 3/4 height modesty panel. Levelers with 1 1/2" (38 mm) height adjustment.</i>				
	Starter				
	73 x 67 1/2 x 33	1825 x 1716 x 834	E_NN-CS677333	1,851	2,110
Add-on <i>Wire access on side panel.</i>	Starter				
	72 x 67 1/2 x 33	1800 x 1716 x 834	E_NN-CA677233	1,608	1,870
Specify the surface type (1, 2).					

Packaged in 2 boxes.

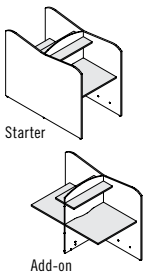
	W x D x H (")	W x D x H (mm)	Code	All Laminate (\$)	HPL Surfaces (\$)
Individual double-sided carrels, 53" H 	<i>Wire opening on top. 3/4 height modesty panel. Levelers with 1 1/2" (38 mm) height adjustment. 8" (200 mm) deep fixed accessory shelf. Clearance 15 3/8" H (390 mm).</i>				
	Starter				
	37 x 67 1/2 x 53	925 x 1716 x 1342	E_NN-CS673753	1,938	2,062
Add-on <i>Wire access on side panel.</i>	Starter				
	36 x 67 1/2 x 53	900 x 1716 x 1342	E_NN-CA673653	1,579	1,700
Specify the surface type (1, 2).					

Packaged in 2 boxes.

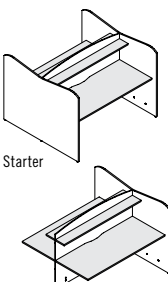
	W x D x H (")	W x D x H (mm)	Code	All Laminate (\$)	HPL Surfaces (\$)
Shared double-sided carrels, 53" H 	<i>Wire opening on top. 3/4 height modesty panel. Levelers with 1 1/2" (38 mm) height adjustment. 8" (200 mm) deep fixed accessory shelf. Clearance 15 3/8" H (390 mm).</i>				
	Starter				
	73 x 67 1/2 x 53	1825 x 1716 x 1342	E_NN-CS677353	2,522	2,775
Add-on <i>Wire access on side panel.</i>	Starter				
	72 x 67 1/2 x 53	1800 x 1716 x 1342	E_NN-CA677253	2,164	2,422
Specify the surface type (1, 2).					

Packaged in 2 boxes.

	W x D x H (")	W x D x H (mm)	Code	All Laminate (\$)	HPL Surfaces (\$)
ADA bracket kit 	<i>Kit includes metal brackets and hardware to raise the surface of a carrel to ADA height (from 29" to 32" H/735 to 813 mm). Package of 6 brackets. Order one package per carrel.</i>				
	1 x 1 x 4	25 x 25 x 104	ENNN-CADAKIT	166	-

COMPUTER CARRELS – 29" H WORK SURFACE

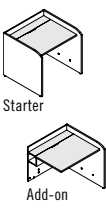
	W x D x H (")	W x D x H (mm)	Code	All Laminate (\$)	HPL Surfaces (\$)
Individual single-sided carrels, 33" H 	<i>Wire management raceway accessible by a lockable cover on hinges. Grommet on back. 3/4 height modesty panel. Levelers with 1 1/2" (38 mm) height adjustment.</i>				
	Starter				
	37 x 67 1/2 x 33	925 x 869 x 834	E_NN-CCS343733	1,388	1,517
Add-on <i>Wire access on side panel.</i>	Starter				
	36 x 34 1/2 x 33	900 x 869 x 834	E_NN-CCA343633	1,172	1,306
Specify the surface type (1, 2).					

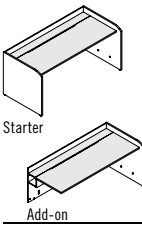
	W x D x H (")	W x D x H (mm)	Code	All Laminate (\$)	HPL Surfaces (\$)
Shared single-sided carrels, 33" H 	<i>Wire management raceway accessible by a lockable cover on hinges. Grommet on back. 3/4 height modesty panel. Levelers with 1 1/2" (38 mm) height adjustment.</i>				
	Starter				
	73 x 34 1/2 x 33	1825 x 869 x 834	E_NN-CCS347333	1,700	1,957
Add-on <i>Wire access on side panel.</i>	Starter				
	72 x 34 1/2 x 33	1800 x 869 x 834	E_NN-CCA347233	1,483	1,743
Specify the surface type (1, 2).					

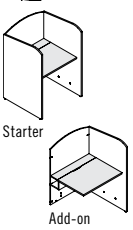
	W x D x H (")	W x D x H (mm)	Code	All Laminate (\$)	HPL Surfaces (\$)
Individual single-sided carrels, 53" H 	<i>Wire management raceway accessible by a lockable cover on hinges. Grommet on back. 3/4 height modesty panel. Levelers with 1 1/2" (38 mm) height adjustment.</i>				
	Starter				
	37 x 34 1/2 x 53	925 x 869 x 1342	E_NN-CCS343753	1,669	1,794
Add-on <i>Wire access on side panel.</i>	Starter				
	36 x 34 1/2 x 53	900 x 869 x 1342	E_NN-CCA343653	1,388	1,526
Specify the surface type (1, 2).					

	W x D x H (")	W x D x H (mm)	Code	All Laminate (\$)	HPL Surfaces (\$)
Shared single-sided carrels, 53" H	<i>Wire management raceway accessible by a lockable cover on hinges. Grommet on back. 3/4 height modesty panel. Levelers with 1 1/2" (38 mm) height adjustment.</i>				
Starter	73 x 34 1/2 x 53	1825 x 869 x 1342	E_NN-CCS347353	2,046	2,306
Add-on	<i>Wire access on side panel.</i>				
	72 x 34 1/2 x 53	1800 x 869 x 1342	E_NN-CCA347253	1,777	2,037

Packaged in 2 boxes.

	W x D x H (")	W x D x H (mm)	Code	All Laminate (\$)	HPL Surfaces (\$)
Individual double-sided carrels, 33" H	<i>Wire management raceway accessible by a lockable cover on hinges. Grommet on back. 3/4 height modesty panel. Levelers with 1 1/2" (38 mm) height adjustment.</i>				
Starter	37 x 67 1/2 x 33	925 x 1716 x 834	E_NN-CCS673733	1,801	1,928
Add-on	<i>Wire access on side panel.</i>				
	36 x 67 1/2 x 33	900 x 1716 x 834	E_NN-CCA673633	1,503	1,627

Packaged in 2 boxes.

	W x D x H (")	W x D x H (mm)	Code	All Laminate (\$)	HPL Surfaces (\$)
Shared double-sided carrels, 33" H	<i>Wire management raceway accessible by a lockable cover on hinges. Grommet on back. 3/4 height modesty panel. Levelers with 1 1/2" (38 mm) height adjustment.</i>				
Starter	73 x 67 1/2 x 33	1825 x 1716 x 834	E_NN-CCS677333	2,355	2,604
Add-on	<i>Wire access on side panel.</i>				
	72 x 67 1/2 x 33	1800 x 1716 x 834	E_NN-CCA677233	2,081	2,337

Packaged in 2 boxes.

	W x D x H (")	W x D x H (mm)	Code	All Laminate (\$)	HPL Surfaces (\$)
Individual double-sided carrels, 53" H	<i>Wire management raceway accessible by a lockable cover on hinges. Grommet on back. 3/4 height modesty panel. Levelers with 1 1/2" (38 mm) height adjustment.</i>				
Starter	37 x 67 1/2 x 53	925 x 1716 x 1342	E_NN-CCS673753	2,337	2,466
Add-on	<i>Wire access on side panel.</i>				
	36 x 67 1/2 x 53	900 x 1716 x 1342	E_NN-CCA673653	1,952	2,081

Packaged in 2 boxes.

	W x D x H (")	W x D x H (mm)	Code	All Laminate (\$)	HPL Surfaces (\$)
Shared double-sided carrels, 53" H	<i>Wire management raceway accessible by a lockable cover on hinges. Grommet on back. 3/4 height modesty panel. Levelers with 1 1/2" (38 mm) height adjustment.</i>				
Starter	73 x 67 1/2 x 53	1825 x 1716 x 1342	E_NN-CCS677353	3,016	3,278
Add-on	<i>Wire access on side panel.</i>				
	72 x 67 1/2 x 53	1800 x 1716 x 1342	E_NN-CCA677253	2,632	2,891

Packaged in 2 boxes.

COMPUTER CARRELS – 42" H WORK SURFACE

	W x D x H (")	W x D x H (mm)	Code	All Laminate (\$)	HPL Surfaces (\$)
Individual single-sided carrels, 53" H	<i>42" H (1063 mm) work surface. Wire management raceway accessible by a lockable cover on hinges. Grommet on back. 3/4 height modesty panel. Levelers with 1 1/2" (38 mm) height adjustment.</i>				
Starter	37 x 34 1/2 x 53	925 x 869 x 1342	E_NN-CSS343753	1,648	1,777
Add-on	<i>Wire access on side panel.</i>				
	36 x 34 1/2 x 53	900 x 869 x 1342	E_NN-CSA343653	1,382	1,510

	W x D x H (")	W x D x H (mm)	Code	All Laminate (\$)	HPL Surfaces (\$)
Shared single-sided carrels, 53" H	<i>42" H (1063 mm) work surface. Wire management raceway accessible by a lockable cover on hinges. Grommet on back. 3/4 height modesty panel. Levelers with 1 1/2" (38 mm) height adjustment.</i>				
Starter	73 x 34 1/2 x 53	1825 x 869 x 1342	E_NN-CSS347353	2,020	2,271
Add-on	<i>Wire access on side panel.</i>				
	72 x 34 1/2 x 53	1800 x 869 x 1342	E_NN-CSA347253	1,743	2,003

Packaged in 2 boxes.

	W x D x H (")	W x D x H (mm)	Code	All Laminate (\$)	HPL Surfaces (\$)
Individual double-sided carrels, 53" H	<i>42" H (1063 mm) work surface. Wire management raceway accessible by a lockable cover on hinges. Grommet on back. 3/4 height modesty panel. Levelers with 1 1/2" (38 mm) height adjustment.</i>				
Starter	37 x 67 1/2 x 53	925 x 1716 x 1342	E_NN-CSS673753	2,313	2,438
Add-on	<i>Wire access on side panel.</i>				
	36 x 67 1/2 x 53	900 x 1716 x 1342	E_NN-CSA673653	1,921	2,046

Packaged in 2 boxes.

	W x D x H (")	W x D x H (mm)	Code	All Laminate (\$)	HPL Surfaces (\$)
Shared double-sided carrels, 53" H	<i>42" H (1063 mm) work surface. Wire management raceway accessible by a lockable cover on hinges. Grommet on back. ¼ height modesty panel. Levelers with 1½" (38 mm) height adjustment.</i>				
Starter	73 x 67½ x 53	1825 x 1716 x 1342	E_NN-CSS677353	2,960	3,219
Add-on	<i>Wire access on side panel.</i>				
	72 x 67½ x 53	1800 x 1716 x 1342	E_NN-CSA677253	2,573	2,825

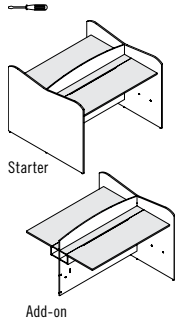

Packaged in 2 boxes.

	W x D x H (")	W x D x H (mm)	Code	All Laminate (\$)	HPL Surfaces (\$)
CPU support for carrels	<i>Laminate CPU support. Compatible with all carrels. Reversible.</i>				
	10 x 26 x 6	255 x 650 x 150	ENNN-SCPU	252	-



RECTANGULAR TABLES

	W x D x H (")	W x D x H (mm)	Code	All Laminate (\$)	HPL Surfaces (\$)
Rectangular tables, incremental height adjustment	<i>Metal legs. 1" (25 mm) incremental height adjustment. 6" (150 mm) range. Lowest position is 25" (635 mm) and highest position is 31" (785 mm) high. 6" (150 mm) high modesty panel.</i>				
	72 x 24 x 25-31	1800 x 600 x 635-785	E_N-RCM2472I	1,451	1,669
	66 x 24 x 25-31	1650 x 600 x 635-785	E_N-RCM2466I	1,434	1,635
	60 x 24 x 25-31	1500 x 600 x 635-785	E_N-RCM2460I	1,419	1,600
	54 x 24 x 25-31	1350 x 600 x 635-785	E_N-RCM2454I	1,399	1,566
	48 x 24 x 25-31	1200 x 600 x 635-785	E_N-RCM2448I	1,382	1,534
	42 x 24 x 25-31	1050 x 600 x 635-785	E_N-RCM2442I	1,375	1,503
	36 x 24 x 25-31	900 x 600 x 635-785	E_N-RCM2436I	1,358	1,467
	30 x 24 x 25-31	750 x 600 x 635-785	E_N-RCM2430I	1,341	1,434



	W x D x H (")	W x D x H (mm)	Code	All Laminate (\$)	HPL Surfaces (\$)
Rectangular tables with shelf, incremental height adjustment	<i>Metal legs. 1 fixed shelf. 1" (25 mm) incremental height adjustment. 6" (150 mm) range. Lowest position is 25" (635 mm) and highest position is 31" (785 mm) high. 6" (150 mm) high modesty panel.</i>				
	72 x 24 x 25-31	1800 x 600 x 635-785	E_N-RCM2472SI	1,686	1,902
	66 x 24 x 25-31	1650 x 600 x 635-785	E_N-RCM2466SI	1,661	1,851
	60 x 24 x 25-31	1500 x 600 x 635-785	E_N-RCM2460SI	1,627	1,837
	54 x 24 x 25-31	1350 x 600 x 635-785	E_N-RCM2454SI	1,600	1,770
	48 x 24 x 25-31	1200 x 600 x 635-785	E_N-RCM2448SI	1,579	1,720
	42 x 24 x 25-31	1050 x 600 x 635-785	E_N-RCM2442SI	1,550	1,676
	36 x 24 x 25-31	900 x 600 x 635-785	E_N-RCM2436SI	1,517	1,627
	30 x 24 x 25-31	750 x 600 x 635-785	E_N-RCM2430SI	1,491	1,586

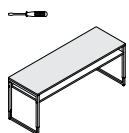

	W x D x H (")	W x D x H (mm)	Code	All Laminate (\$)	HPL Surfaces (\$)
Rectangular tables, fixed height	<i>Metal legs. 6" (150 mm) high modesty panel.</i>				
	72 x 24 x 29	1800 x 600 x 735	E_N-RCM2472J	1,146	1,370
	66 x 24 x 29	1650 x 600 x 735	E_N-RCM2466J	1,132	1,333
	60 x 24 x 29	1500 x 600 x 735	E_N-RCM2460J	1,114	1,299
	54 x 24 x 29	1350 x 600 x 735	E_N-RCM2454J	1,096	1,268
	48 x 24 x 29	1200 x 600 x 735	E_N-RCM2448J	1,089	1,229
	42 x 24 x 29	1050 x 600 x 735	E_N-RCM2442J	1,074	1,198
	36 x 24 x 29	900 x 600 x 735	E_N-RCM2436J	1,056	1,164
	30 x 24 x 29	750 x 600 x 735	E_N-RCM2430J	1,038	1,132

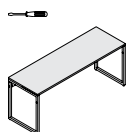

	W x D x H (")	W x D x H (mm)	Code	All Laminate (\$)	HPL Surfaces (\$)
Rectangular tables with shelf, fixed height	<i>Metal legs. 1 fixed shelf. 6" (150 mm) high modesty panel.</i>				
	72 x 24 x 29	1800 x 600 x 735	E_N-RCM2472SJ	1,382	1,600
	66 x 24 x 29	1650 x 600 x 735	E_N-RCM2466SJ	1,358	1,559
	60 x 24 x 29	1500 x 600 x 735	E_N-RCM2460SJ	1,333	1,534
	54 x 24 x 29	1350 x 600 x 735	E_N-RCM2454SJ	1,299	1,467
	48 x 24 x 29	1200 x 600 x 735	E_N-RCM2448SJ	1,274	1,419
	42 x 24 x 29	1050 x 600 x 735	E_N-RCM2442SJ	1,249	1,375
	36 x 24 x 29	900 x 600 x 735	E_N-RCM2436SJ	1,223	1,333
	30 x 24 x 29	750 x 600 x 735	E_N-RCM2430SJ	1,190	1,281

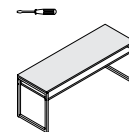

Specify the surface type (1, 2). Specify the accent color (A, S).

LAPTOP TABLES

	W x D x H (")	W x D x H (mm)	Code	All Laminate (\$)	HPL Surfaces (\$)
Laptop tables, 30" D, incremental height adjustment	<i>Metal legs. 1" (25 mm) incremental height adjustment. 6" (150 mm) range. Lowest position is 25" H (635 mm). Highest position is 31" (785 mm) H. 6" (150 mm) high modesty panel. Wire management raceway accessible by a lockable cover on hinges.</i>				
	72 x 30 x 25-31	1800 x 750 x 635-785	E_N-RLP3072I	1,843	2,120
	66 x 30 x 25-31	1650 x 750 x 635-785	E_N-RLP3066I	1,830	2,068
	60 x 30 x 25-31	1500 x 750 x 635-785	E_N-RLP3060I	1,801	2,028
	54 x 30 x 25-31	1350 x 750 x 635-785	E_N-RLP3054I	1,777	1,980
	48 x 30 x 25-31	1200 x 750 x 635-785	E_N-RLP3048I	1,751	1,938
	42 x 30 x 25-31	1050 x 750 x 635-785	E_N-RLP3042I	1,726	1,887
	36 x 30 x 25-31	900 x 750 x 635-785	E_N-RLP3036I	1,700	1,837

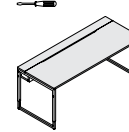

Specify the surface type (1, 2). Specify the accent color (A, S).

	W x D x H (")	W x D x H (mm)	Code	All Laminate (\$)	HPL Surfaces (\$)
Laptop tables, 24" D, incremental height adjustment	<i>Metal legs. 1" (25 mm) incremental height adjustment. 6" (150 mm) range. Lowest position is 25" H (635 mm). Highest position is 31" (785 mm) H. 6" (150 mm) high modesty panel. Wire management raceway accessible by a lockable cover on hinges.</i>				
	72 x 24 x 25-31	1800 x 600 x 635-785	E_N-RLP2472I	1,808	2,028
	66 x 24 x 25-31	1650 x 600 x 635-785	E_N-RLP2466I	1,794	1,986
	60 x 24 x 25-31	1500 x 600 x 635-785	E_N-RLP2460I	1,770	1,952
	54 x 24 x 25-31	1350 x 600 x 635-785	E_N-RLP2454I	1,751	1,912
	48 x 24 x 25-31	1200 x 600 x 635-785	E_N-RLP2448I	1,726	1,870
	42 x 24 x 25-31	1050 x 600 x 635-785	E_N-RLP2442I	1,700	1,837
	36 x 24 x 25-31	900 x 600 x 635-785	E_N-RLP2436I	1,686	1,794

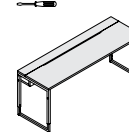

Specify the surface type (1, 2). Specify the accent color (A, S).

	W x D x H (")	W x D x H (mm)	Code	All Laminate (\$)	HPL Surfaces (\$)
Laptop tables, 30" D, fixed height	<i>Metal legs. 6" (150 mm) high modesty panel. Wire management raceway accessible by a lockable cover on hinges.</i>				
	72 x 30 x 29	1800 x 750 x 735	E_N-RLP3072J	1,550	1,819
	66 x 30 x 29	1650 x 750 x 735	E_N-RLP3066J	1,526	1,777
	60 x 30 x 29	1500 x 750 x 735	E_N-RLP3060J	1,503	1,726
	54 x 30 x 29	1350 x 750 x 735	E_N-RLP3054J	1,476	1,676
	48 x 30 x 29	1200 x 750 x 735	E_N-RLP3048J	1,451	1,635
	42 x 30 x 29	1050 x 750 x 735	E_N-RLP3042J	1,426	1,586
	36 x 30 x 29	900 x 750 x 735	E_N-RLP3036J	1,399	1,541

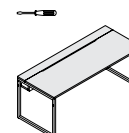

Specify the surface type (1, 2). Specify the accent color (A, S).

	W x D x H (")	W x D x H (mm)	Code	All Laminate (\$)	HPL Surfaces (\$)
Laptop tables, 24" D, fixed height	<i>Metal legs. 6" (150 mm) high modesty panel. Wire management raceway accessible by a lockable cover on hinges.</i>				
	72 x 24 x 29	1800 x 600 x 735	E_N-RLP2472J	1,510	1,726
	66 x 24 x 29	1650 x 600 x 735	E_N-RLP2466J	1,491	1,693
	60 x 24 x 29	1500 x 600 x 735	E_N-RLP2460J	1,467	1,648
	54 x 24 x 29	1350 x 600 x 735	E_N-RLP2454J	1,451	1,608
	48 x 24 x 29	1200 x 600 x 735	E_N-RLP2448J	1,426	1,566
	42 x 24 x 29	1050 x 600 x 735	E_N-RLP2442J	1,409	1,534
	36 x 24 x 29	900 x 600 x 735	E_N-RLP2436J	1,382	1,491

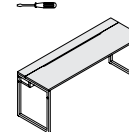

Specify the surface type (1, 2). Specify the accent color (A, S).

EDUCATIONAL FURNITURE

	W x D x H (*)	W x D x H (mm)	Code	All Laminates (\$)	HPL Surfaces (\$)
--	---------------	----------------	------	--------------------	-------------------

CPU TABLES

Left CPU tables *Open CPU storage on left: 8¾" W x 20½" H (222 x 522 mm). Half-height modesty panel. Grommet on sides. Wire management raceway accessible by a lockable cover on hinges.*



42 x 30 x 36	1050 x 750 x 911	E_N_-CPU3042S	1,887	2,003
42 x 24 x 36	1050 x 600 x 911	E_N_-CPU2442S	1,801	1,894

Specify the surface type (1, 2). Specify the accent color (A, S).

Packaged in 2 boxes.

Right CPU tables *Open CPU storage on left: 8¾" W x 20½" H (222 x 522 mm). Half-height modesty panel. Grommet on sides. Wire management raceway accessible by a lockable cover on hinges.*



42 x 30 x 36	1050 x 750 x 911	E_N_-S3042CPU	1,887	2,003
42 x 24 x 36	1050 x 600 x 911	E_N_-S2442CPU	1,801	1,894

Specify the surface type (1, 2). Specify the accent color (A, S).

Packaged in 2 boxes.

ALL-PURPOSE TABLES

Rectangular tables

Disc bases.

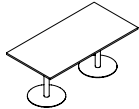

72 x 42 x 29	1800 x 1050 x 738	E_N_-RC4272D	2,814	3,193
72 x 36 x 29	1800 x 900 x 738	E_N_-RC3672D	2,783	3,111
60 x 30 x 29	1500 x 750 x 738	E_N_-RC3060D	2,719	2,942

Specify the surface type (1, 2). Specify the accent color (A, S).

Packaged in 5 boxes.

Rectangular café height tables

Disc bases.

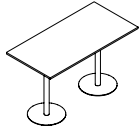

72 x 42 x 42	1800 x 1050 x 1067	E_N_-RC427242D	2,960	3,333
72 x 36 x 42	1800 x 900 x 1067	E_N_-RC367242D	2,924	3,253
60 x 30 x 42	1500 x 750 x 1067	E_N_-RC306042D	2,859	3,084

Specify the surface type (1, 2). Specify the accent color (A, S).

Packaged in 5 boxes.

Round tables

Disc base.



48 x 48 x 29	1200 x 1200 x 738	E_N_-R48D	1,857	2,154
42 x 42 x 29	1050 x 1050 x 738	E_N_-R42D	1,819	2,037
36 x 36 x 29	900 x 900 x 738	E_N_-R36D	1,534	1,693

Specify the surface type (1, 2). Specify the accent color (A, S).

Packaged in 3 boxes.

Round café height tables

Disc base.

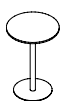

36 x 36 x 42	900 x 900 x 1067	E_N_-R3642D	1,467	1,693
30 x 30 x 42	750 x 750 x 1067	E_N_-R3042D	1,419	1,566

Specify the surface type (1, 2). Specify the accent color (A, S).

Packaged in 3 boxes.

COMPLEMENTARY FURNITURE

Pedestal *2 box drawers and 1 file drawer with suspension bar. Pencil tray. Lock controls all drawers.*



16¾ x 26 x 29	409 x 650 x 735	E1_-P1626UF	1,635	-
---------------	-----------------	-------------	-------	---

Specify the handle code (L, Q, V). Specify the accent color (A, S).

Pedestal *2 file drawers with suspension bar. Lock controls all drawers.*



16¾ x 26 x 29	409 x 650 x 735	E1_-P1626FF	1,399	-
---------------	-----------------	-------------	-------	---

Specify the handle code (L, Q, V). Specify the accent color (A, S).

Bookcase unit

1 adjustable shelf. 1 tone only.



W x D x H (*)	W x D x H (mm)	Code	All Laminates (\$)	HPL Surfaces (\$)
12 x 26 x 28	300 x 650 x 710	ENNN-B262812	782	-

Teacher's cart

Handle on left side. 1 adjustable shelf. 1 fixed shelf with 22½" W x 21⅝" D x 5¼" H (572 x 551 x 134 mm) open storage space. Swivel wire supports. 1 grommet on top and 1 grommet on back. 4 swivel casters, 2 with brakes.



25 x 24 x 39	625 x 600 x 988	E_N_-M242539	1,388	1,467
--------------	-----------------	--------------	-------	-------

Specify the surface type (1, 2). Specify the accent color (A, S).

Teacher's cart

Handle on left side. 1 adjustable shelf. 1 fixed shelf with 22½" W x 21⅝" D x 5¼" H (572 x 551 x 134 mm) open storage space. Swivel wire supports. 1 grommet on top and 1 grommet on back. Flipper shelf on right side. 4 swivel casters, 2 with brakes.



37¼ x 24 x 39	945 x 600 x 988	E_N_-M242539W	1,686	1,758
---------------	-----------------	---------------	-------	-------

Specify the surface type (1, 2). Specify the accent color (A, S).

Teacher's cart with doors

Handle on left side. 1 adjustable shelf. 1 fixed shelf with 22½" W x 21⅝" D x 5¼" H (572 x 551 x 134 mm) open storage space. Lock. Swivel wire supports. 1 grommet on top and 1 grommet on back. 4 swivel casters, 2 with brakes.



25 x 24 x 39	625 x 600 x 988	E_-M242539B	1,808	1,887
--------------	-----------------	-------------	-------	-------

Specify the surface type (1, 2). Specify the handle code (L, Q, V). Specify the accent color (A, S).

Teacher's cart with doors

Handle on left side. 1 adjustable shelf. 1 fixed shelf with 22½" W x 21⅝" D x 5¼" H (572 x 551 x 134 mm) open storage space. Lock. Swivel wire supports. 1 grommet on top and 1 grommet on back. Flipper shelf on right side. 4 swivel casters, 2 with brakes.



37¼ x 24 x 39	945 x 600 x 988	E_-M242539BW	2,037	2,110
---------------	-----------------	--------------	-------	-------

Specify the surface type (1, 2). Specify the handle code (L, Q, V). Specify the accent color (A, S).

Lectern

Small acrylic screen. 1 fixed shelf. 1 adjustable shelf. 1 storage space. Wiring access. 4 swivel casters, 2 with brakes. 1 tone only.



24 x 18 x 47	600 x 448 x 1177	ENNN-LC241846	1,526	-
--------------	------------------	---------------	-------	---

Laptop cart, 30 units

Can accommodate 30 laptops. 2 handles on top. Laminate door fronts with lock. Swivel wire supports. Perforated back metal doors with lock for ventilation. Storage space for wire management and transformers. Grommet on sides. 4 swivel casters, 2 with brakes. Surge and protection power bar sold separately.



43 x 25 x 42	1075 x 625 x 1063	E_-M254342LP	4,668	4,804
--------------	-------------------	--------------	-------	-------

Specify the surface type (1, 2). Specify the handle code (Q, V). Specify the accent color (A, S).

Laptop cart, 20 units

Can accommodate 20 laptops. 2 handles on top. Laminate door fronts with lock. Swivel wire supports. Perforated back metal doors with lock for ventilation. Storage space for wire management and transformers. Grommet on sides. 4 swivel casters, 2 with brakes. Surge and protection power bar sold separately.



30 x 25 x 42	750 x 625 x 1063	E_-M253042LP	4,300	4,401
--------------	------------------	--------------	-------	-------

Specify the surface type (1, 2). Specify the handle code (Q, V). Specify the accent color (A, S).

Power bar

10 electrical outlets. Black. Mounting brackets included. 12' electrical cord (3658 mm).



1¾ x 2¼ x 17½	44 x 57 x 447	LGC-POWERBAR	664	-
---------------	---------------	--------------	-----	---

Flat screen carts

Laminate doors with locks. 2 adjustable shelves. Recessed back panel for wire management. Grommets on back. 6 swivel casters, 4 with brakes. 1 tone only. Flat screen support sold separately.

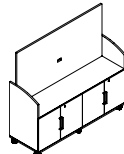

72 x 24 x 64	1800 x 600 x 1625	EN_-MTV2472	2,917	-
--------------	-------------------	-------------	-------	---

54 x 24 x 64	1350 x 600 x 1625	EN_-MTV2454	2,674	-
--------------	-------------------	-------------	-------	---

Specify the handle code (L, Q, V). Specify the accent color (A, S).

72" W accommodates 37" to 65" flat screens.
54" W accommodates 37" to 50" flat screens.

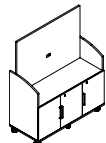

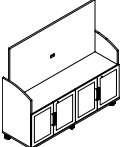

ASSEMBLY REQUIRED

USA - FEBRUARY 2025

	W x D x H (")	W x D x H (mm)	Code	All Laminate (\$)	HPL Surfaces (\$)
Flat screen carts with translucent doors 	<i>Silver anodized frame doors and translucent insert with locks. 2 adjustable shelves. Recessed back panel for wire management. Grommets on back. 6 swivel casters, 4 with brakes. 1 tone only. Flat screen support sold separately. S Silver accent only.</i>				
	72 x 24 x 64	1800 x 600 x 1625	EN_S-MTV2472T	3,756	—
	54 x 24 x 64	1350 x 600 x 1625	EN_S-MTV2454T	3,304	—
Specify the handle code (Q, V).					
72" W accommodates 37" to 65" flat screens. 54" W accommodates 37" to 50" flat screens.					

	W x D x H (")	W x D x H (mm)	Code	All Laminate (\$)	HPL Surfaces (\$)
Flat screen support 	<i>Silver metal support. Can accommodate screens from 37" to 65". 15° tilt angle. Maximum weight capacity: 176 lbs (80 kg). Install on a flat screen carts.</i>				
	33 3/8 x 4 x 19 3/4	859 x 102 x 500	LGC-SUPFLATSC	747	—

	W x D x H (")	W x D x H (mm)	Code	All Laminate (\$)	HPL Surfaces (\$)
Mobile white boards 	<i>Non-magnetic surface for use with dry-erase markers on both sides. Brakes on swivel casters.</i>				
	55 x 28 x 64	1375 x 700 x 1610	ENN_-MWB542865	2,632	—
	43 x 28 x 64	1075 x 700 x 1610	ENN_-MWB422865	2,580	—
Specify the accent color (A, S).					

	W x D x H (")	W x D x H (mm)	Code	All Laminate (\$)	HPL Surfaces (\$)
Pencil tray 	<i>For mobile white board. Specify the metal finish Silver or Anthracite grey.</i>				
	12 x 3 1/2 x 2	300 x 90 x 50	LGC-PH12_	127	—
Specify the accent color (A, S).					

STORAGE UNITS, 72" H

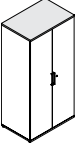
	W x D x H (")	W x D x H (mm)	Code	All Laminate (\$)	HPL Surfaces (\$)
Storage unit with doors 	<i>3 adjustable shelves and 1 fixed shelf. Lock.</i>				
	36 x 24 x 72	900 x 600 x 1825	E1__-B243672	2,456	—
Specify the handle code (L, Q, V). Specify the accent color (A, S).					

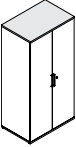
	W x D x H (")	W x D x H (mm)	Code	All Laminate (\$)	HPL Surfaces (\$)
Combined wardrobe/storage unit with doors 	<i>Clothes hanger bar and 1 fixed shelf on right side. 4 adjustable shelves on left side. Lock.</i>				
	36 x 24 x 72	900 x 600 x 1825	E1__-243672BC	2,708	—
Specify the handle code (L, Q, V). Specify the accent color (A, S).					

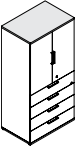
	W x D x H (")	W x D x H (mm)	Code	All Laminate (\$)	HPL Surfaces (\$)
Storage unit with drawers 	<i>2 adjustable shelves. 4 box drawers. Interlock system. Locks.</i>				
	36 x 24 x 72	900 x 600 x 1825	E1__-243672BU	4,207	—
Specify the handle code (L, Q, V). Specify the accent color (A, S).					

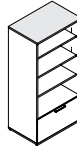
	W x D x H (")	W x D x H (mm)	Code	All Laminate (\$)	HPL Surfaces (\$)
Open bookcase with drawer 	<i>2 adjustable shelves and 1 fixed shelf. Lateral file drawer with suspension bars. Lock.</i>				
	36 x 24 x 72	900 x 600 x 1825	E1__-B243672F	2,415	—
Specify the handle code (L, Q, V). Specify the accent color (A, S).					

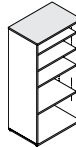
	W x D x H (")	W x D x H (mm)	Code	All Laminate (\$)	HPL Surfaces (\$)
Open bookcase 	<i>3 adjustable shelves and 1 fixed shelf.</i>				
	36 x 24 x 72	900 x 600 x 1825	E1NN-B243672	1,928	—

STORAGE UNITS, 36" H

	W x D x H (")	W x D x H (mm)	Code	All Laminate (\$)	HPL Surfaces (\$)
Bookcase with doors 	<i>1 adjustable shelf. Lock.</i>				
	36 x 24 x 36	900 x 600 x 911	E___-243636B	1,669	1,777
Specify the surface type (1, 2). Specify the handle code (L, Q, V). Specify the accent color (A, S).					

	W x D x H (")	W x D x H (mm)	Code	All Laminate (\$)	HPL Surfaces (\$)
Mobile bookcase with doors 	<i>1 adjustable shelf. Lock. 4 swivel casters, 2 with brakes.</i>				
	36 x 24 x 36	900 x 600 x 911	E___-M243636B	1,736	1,843
Specify the surface type (1, 2). Specify the handle code (L, Q, V). Specify the accent color (A, S).					

	W x D x H (")	W x D x H (mm)	Code	All Laminate (\$)	HPL Surfaces (\$)
Storage unit with drawers 	<i>4 box drawers. Interlock system. Lock.</i>				
	36 x 24 x 36	900 x 600 x 911	E___-243636U	2,942	3,051
Specify the surface type (1, 2). Specify the handle code (L, Q, V). Specify the accent color (A, S).					

	W x D x H (")	W x D x H (mm)	Code	All Laminate (\$)	HPL Surfaces (\$)
Mobile storage unit with drawers 	<i>4 box drawers. Interlock system. Lock. 4 swivel casters, 2 with brakes.</i>				
	36 x 24 x 36	900 x 600 x 911	E___-M243636U	3,010	3,117
Specify the surface type (1, 2). Specify the handle code (L, Q, V). Specify the accent color (A, S).					

	W x D x H (")	W x D x H (mm)	Code	All Laminate (\$)	HPL Surfaces (\$)
Combined storage unit 	<i>4 box drawers on left. Bookcase with door on right. 1 adjustable shelf. Locks.</i>				
	36 x 24 x 36	900 x 600 x 911	E___-243636UB	3,253	3,362
Specify the surface type (1, 2). Specify the handle code (Q, V). Specify the accent color (A, S).					

	W x D x H (")	W x D x H (mm)	Code	All Laminate (\$)	HPL Surfaces (\$)
Mobile combined storage unit 	<i>4 box drawers on left. Bookcase with door on right. 1 adjustable shelf. Locks. 4 swivel casters, 2 with brakes.</i>				
	36 x 24 x 36	900 x 600 x 911	E___-M243636UB	3,319	3,428
Specify the surface type (1, 2). Specify the handle code (Q, V). Specify the accent color (A, S).					

	W x D x H (")	W x D x H (mm)	Code	All Laminate (\$)	HPL Surfaces (\$)
Combined storage unit 	<i>4 box drawers on right. Bookcase with door on left. 1 adjustable shelf. Locks.</i>				
	36 x 24 x 36	900 x 600 x 911	E___-243636BU	3,253	3,362
Specify the surface type (1, 2). Specify the handle code (Q, V). Specify the accent color (A, S).					

	W x D x H (")	W x D x H (mm)	Code	All Laminate (\$)	HPL Surfaces (\$)
Mobile combined storage unit	<i>4 box drawers on right. Bookcase with door on left. 1 adjustable shelf. Locks. 4 swivel casters, 2 with brakes.</i>				
	36 x 24 x 36	900 x 600 x 911	E___-M243636BU	3,319	3,428
	Specify the surface type (1, 2). Specify the handle code (Q, V). Specify the accent color (A, S).				

Combined storage unit	<i>2 box drawers. Bookcase with doors. 1 adjustable shelf. Locks.</i>				
	36 x 24 x 36	900 x 600 x 911	E___-243636T	2,597	2,708
	Specify the surface type (1, 2). Specify the handle code (L, Q, V). Specify the accent color (A, S).				

Mobile combined storage unit	<i>2 box drawers. Bookcase with doors. 1 adjustable shelf. Locks. 4 swivel casters, 2 with brakes.</i>				
	36 x 24 x 36	900 x 600 x 911	E___-M243636T	2,669	2,775
	Specify the surface type (1, 2). Specify the handle code (L, Q, V). Specify the accent color (A, S).				

STORAGE UNITS, 29" H

Bookcase with doors	<i>1 adjustable shelf. Lock.</i>				
	36 x 24 x 29	900 x 600 x 735	E___-243629B	1,600	1,706
	Specify the surface type (1, 2). Specify the handle code (L, Q, V). Specify the accent color (A, S).				

Mobile bookcase with doors	<i>1 adjustable shelf. Lock. 4 swivel casters, 2 with brakes.</i>				
	36 x 24 x 29	900 x 600 x 735	E___-M243629B	1,669	1,777
	Specify the surface type (1, 2). Specify the handle code (L, Q, V). Specify the accent color (A, S).				

Bookcase with door, opens left	<i>1 adjustable shelf. Lock.</i>				
	24 x 24 x 29	600 x 600 x 735	E___-242429BL	1,476	1,550
	Specify the surface type (1, 2). Specify the handle code (Q, V). Specify the accent color (A, S).				

Bookcase with door, opens right	<i>1 adjustable shelf. Lock.</i>				
	24 x 24 x 29	600 x 600 x 735	E___-242429BR	1,476	1,550
	Specify the surface type (1, 2). Specify the handle code (Q, V). Specify the accent color (A, S).				

Mobile bookcase with door, opens left	<i>1 adjustable shelf. 4 swivel casters, 2 with brakes. Lock.</i>				
	24 x 24 x 29	600 x 600 x 735	E___-M242429BL	1,541	1,619
	Specify the surface type (1, 2). Specify the handle code (Q, V). Specify the accent color (A, S).				

Mobile bookcase with door, opens right	<i>1 adjustable shelf. 4 swivel casters, 2 with brakes. Lock.</i>				
	24 x 24 x 29	600 x 600 x 735	E___-M242429BR	1,541	1,619
	Specify the surface type (1, 2). Specify the handle code (Q, V). Specify the accent color (A, S).				

Storage units with drawers	<i>3 box drawers. Interlock system. Lock.</i>				
	36 x 24 x 29	900 x 600 x 735	E___-243629U	2,669	2,775
	24 x 24 x 29	600 x 600 x 735	E___-242429U	2,573	2,680
	Specify the surface type (1, 2). Specify the handle code (L, Q, V). Specify the accent color (A, S).				

	W x D x H (")	W x D x H (mm)	Code	All Laminate (\$)	HPL Surfaces (\$)
Mobile storage units with drawers	<i>3 box drawers. Interlock system. Lock. 4 swivel casters, 2 with brakes.</i>				
	36 x 24 x 29	900 x 600 x 735	E___-M243629U	2,732	2,841
	24 x 24 x 29	600 x 600 x 735	E___-M242429U	2,641	2,750
	Specify the surface type (1, 2). Specify the handle code (L, Q, V). Specify the accent color (A, S).				

Combined storage unit	<i>3 box drawers on left. Bookcase with door on right. 1 adjustable shelf. Locks.</i>				
	36 x 24 x 29	900 x 600 x 735	E___-243629UB	2,641	2,750
	Specify the surface type (1, 2). Specify the handle code (Q, V). Specify the accent color (A, S).				

Mobile combined storage unit	<i>3 box drawers on left. Bookcase with door on right. 1 adjustable shelf. Locks. 4 swivel casters, 2 with brakes.</i>				
	36 x 24 x 29	900 x 600 x 735	E___-M243629UB	2,708	2,814
	Specify the surface type (1, 2). Specify the handle code (Q, V). Specify the accent color (A, S).				

Combined storage unit	<i>3 box drawers on right. Bookcase with door on left. 1 adjustable shelf. Locks.</i>				
	36 x 24 x 29	900 x 600 x 735	E___-243629BU	2,641	2,750
	Specify the surface type (1, 2). Specify the handle code (Q, V). Specify the accent color (A, S).				

Mobile combined storage unit	<i>3 box drawers on right. Bookcase with door on left. 1 adjustable shelf. Locks. 4 swivel casters, 2 with brakes.</i>				
	36 x 24 x 29	900 x 600 x 735	E___-M243629BU	2,708	2,814
	Specify the surface type (1, 2). Specify the handle code (Q, V). Specify the accent color (A, S).				

BOOKCASE UNITS, 36" H

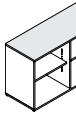
Bookcase units	<i>2 adjustable shelves.</i>				
	60 x 24 x 36	1500 x 600 x 911	E_NN-B246036	1,434	1,579
	48 x 24 x 36	1200 x 600 x 911	E_NN-B244836	1,281	1,409
	<i>1 adjustable shelf.</i>				
	36 x 24 x 36	900 x 600 x 911	E_NN-B243636	1,146	1,259
	Specify the surface type (1, 2).				

Mobile bookcase units	<i>2 adjustable shelves. 6 swivel casters, 4 with brakes.</i>				
	60 x 24 x 36	1500 x 600 x 911	E_NN-MB246036	1,534	1,676
	48 x 24 x 36	1200 x 600 x 911	E_NN-MB244836	1,382	1,510
	<i>1 adjustable shelf. 4 swivel casters, 2 with brakes.</i>				
	36 x 24 x 36	900 x 600 x 911	E_NN-MB243636	1,216	1,325
	Specify the surface type (1, 2).				

BOOKCASE UNITS, 29" H

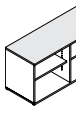
Bookcase units	<i>2 adjustable shelves.</i>				
	60 x 24 x 29	1500 x 600 x 735	E_NN-B246029	1,399	1,534
	48 x 24 x 29	1200 x 600 x 735	E_NN-B244829	1,259	1,370
	<i>1 adjustable shelf.</i>				
	36 x 24 x 29	900 x 600 x 735	E_NN-B243629	1,114	1,223
	Specify the surface type (1, 2).				

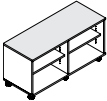

	W x D x H (")	W x D x H (mm)	Code	All Laminate (\$)	HPL Surfaces (\$)
Mobile bookcase units	<i>2 adjustable shelves. 6 swivel casters, 4 with brakes.</i>				
	60 x 24 x 29	1500 x 600 x 735	E_NN-MB246029	1,503	1,635
	48 x 24 x 29	1200 x 600 x 735	E_NN-MB244829	1,358	1,467
	<i>1 adjustable shelf. 4 swivel casters, 2 with brakes.</i>				
	36 x 24 x 29	900 x 600 x 735	E_NN-MB243629	1,184	1,292

Specify the surface type (1, 2).



Handle



For mobile units. Specify the metal finish Silver or Anthracite grey.

17¼ x ¾ x 2¾	438 x 22 x 60	LGC-PULL17_	159	-
--------------	---------------	-------------	-----	---

Specify the accent color (A, S).

Bookcases

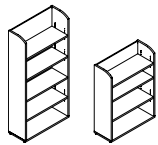

3 adjustable shelves. 1 fixed shelf. 1 tone only.

36 x 14 x 72	900 x 350 x 1825	ENNN-B367214	1,375	-
--------------	------------------	--------------	-------	---

2 adjustable shelves. 1 fixed shelf. 1 tone only.

36 x 14 x 48	900 x 350 x 1215	ENNN-B364814	1,146	-
--------------	------------------	--------------	-------	---

MODULAR CABINETRY

Modular cabinet with doors

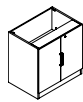

Installs under a countertop. 1 adjustable shelf. 4¼" H (106 mm) kick plate. Lock. 1 tone only.

36 x 25 x 35	900 x 625 x 886	EN__-253635BL	1,669	-
--------------	-----------------	---------------	-------	---

Specify the handle code (L, Q, V). Specify the accent color (A, S).

Modular cabinets with door, opens left

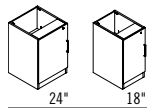

Installs under a countertop. 1 adjustable shelf. 4¼" H (106 mm) kick plate. Lock. 1 tone only.

24 x 25 x 35	600 x 625 x 886	EN__-252435BLL	1,541	-
--------------	-----------------	----------------	-------	---

18 x 25 x 35	450 x 625 x 886	EN__-251835BLL	1,184	-
--------------	-----------------	----------------	-------	---

Specify the handle code (Q, V). Specify the accent color (A, S).

Modular cabinets with door, opens right

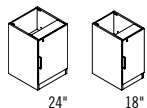

Installs under a countertop. 1 adjustable shelf. 4¼" H (106 mm) kick plate. Lock. 1 tone only.

24 x 25 x 35	600 x 625 x 886	EN__-252435BLR	1,541	-
--------------	-----------------	----------------	-------	---

18 x 25 x 35	450 x 625 x 886	EN__-251835BLR	1,184	-
--------------	-----------------	----------------	-------	---

Specify the handle code (Q, V). Specify the accent color (A, S).

Modular sink cabinet with doors

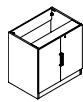

Installs under a countertop. 4¼" H (106 mm) kick plate. Open back to accommodate plumbing. Lock. 1 tone only.

36 x 25 x 35	900 x 625 x 886	EN__-253635KL	1,758	-
--------------	-----------------	---------------	-------	---

Specify the handle code (L, Q, V). Specify the accent color (A, S).

Modular sink cabinet with door, opens left



Installs under a countertop. 4¼" H (106 mm) kick plate. Open back to accommodate plumbing. Lock. 1 tone only.

24 x 25 x 35	600 x 625 x 886	EN__-252435KLL	1,635	-
--------------	-----------------	----------------	-------	---

Specify the handle code (Q, V). Specify the accent color (A, S).

Modular sink cabinet with door, opens right



Installs under a countertop. 4¼" H (106 mm) kick plate. Open back to accommodate plumbing. Lock. 1 tone only.

24 x 25 x 35	600 x 625 x 886	EN__-252435KLR	1,635	-
--------------	-----------------	----------------	-------	---

Specify the handle code (Q, V). Specify the accent color (A, S).

Modular cabinet with drawers



W x D x H (")	W x D x H (mm)	Code	All Laminate (\$)	HPL Surfaces (\$)
<i>Installs under a countertop. 4 drawers. 4¼" H (106 mm) kick plate. Lock. 1 tone only.</i>				
36 x 25 x 35	900 x 625 x 886	EN__-253635UL	2,540	-

Specify the handle code (L, Q, V). Specify the accent color (A, S).

Modular cabinets with drawers



<i>Installs under a countertop. 4 drawers. 4¼" H (106 mm) kick plate. Lock. 1 tone only.</i>				
24 x 25 x 35	600 x 625 x 886	EN__-252435UL	2,415	-
18 x 25 x 35	450 x 625 x 886	EN__-251835UL	2,195	-

Specify the handle code (L, Q, V). Specify the accent color (A, S).

Modular cabinet with drawers



Installs under a countertop. 3 box drawers and 1 file drawer. 4¼" H (106 mm) kick plate. Locks. 1 tone only.

36 x 25 x 35	900 x 625 x 886	EN__-253635UFL	2,497	-
--------------	-----------------	----------------	-------	---

Specify the handle code (L, Q, V). Specify the accent color (A, S).

Modular cabinet with drawers



Installs under a countertop. 2 box drawers and 1 file drawer. 4¼" H (106 mm) kick plate. Lock. 1 tone only.

24 x 25 x 35	600 x 625 x 886	EN__-252435UFL	2,372	-
--------------	-----------------	----------------	-------	---

Specify the handle code (L, Q, V). Specify the accent color (A, S).

Modular cabinet with doors and drawers



Installs under a countertop. 2 box drawers. 1 adjustable shelf. 4¼" H (106 mm) kick plate. Locks. 1 tone only.

36 x 25 x 35	900 x 625 x 886	EN__-253635TL	2,103	-
--------------	-----------------	---------------	-------	---

Specify the handle code (L, Q, V). Specify the accent color (A, S).

Modular cabinet with door and drawer, opens left



Installs under a countertop. 1 box drawer. 1 adjustable shelf. 4¼" H (106 mm) kick plate. Lock. 1 tone only.

24 x 25 x 35	600 x 625 x 886	EN__-252435TLL	1,980	-
--------------	-----------------	----------------	-------	---

Specify the handle code (Q, V). Specify the accent color (A, S).

Modular cabinet with door and drawer, opens right



Installs under a countertop. 1 box drawer. 1 adjustable shelf. 4¼" H (106 mm) kick plate. Lock. 1 tone only.

24 x 25 x 35	600 x 625 x 886	EN__-252435TLR	1,980	-
--------------	-----------------	----------------	-------	---

Specify the handle code (Q, V). Specify the accent color (A, S).

Modular bookcases

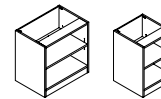

Installs under a countertop. 1 adjustable shelf. 4¼" H (106 mm) kick plate. 1 tone only.

36 x 25 x 35	900 x 625 x 886	ENNN-B253635L	1,229	-
--------------	-----------------	---------------	-------	---

24 x 25 x 35	600 x 625 x 886	ENNN-B252435L	1,108	-
--------------	-----------------	---------------	-------	---

Open modules



Installs under a countertop. 1 tone only.

36 x 25 x 35	900 x 625 x 886	ENNN-253635SL	797	-
--------------	-----------------	---------------	-----	---

24 x 25 x 35	600 x 625 x 886	ENNN-252435SL	747	-
--------------	-----------------	---------------	-----	---

ADA sink module



Installs under a countertop. Open back to accommodate plumbing. Pivoting front panel for plumbing accessibility. 1 tone only.

36 x 25 x 35	900 x 625 x 886	ENNN-AD253635L	1,074	-
--------------	-----------------	----------------	-------	---

EDUCATIONAL FURNITURE

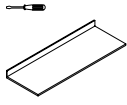
	W x D x H (")	W x D x H (mm)	Code	All Laminate (\$)	HPL Surfaces (\$)
Rectangular counter tops	<i>Installs on modular cabinets. 4" H (100 mm) back splash. 1 tone only.</i>				
	96 x 26 x 5	2400 x 650 x 125	E_NN-TOBS2696	671	1,012
	90 x 26 x 5	2250 x 650 x 125	E_NN-TOBS2690	654	989
	84 x 26 x 5	2100 x 650 x 125	E_NN-TOBS2684	638	963
	78 x 26 x 5	1950 x 650 x 125	E_NN-TOBS2678	620	938
	72 x 26 x 5	1800 x 650 x 125	E_NN-TOBS2672	603	912
	66 x 26 x 5	1650 x 650 x 125	E_NN-TOBS2666	586	890
	60 x 26 x 5	1500 x 650 x 125	E_NN-TOBS2660	571	864
	54 x 26 x 5	1350 x 650 x 125	E_NN-TOBS2654	553	837
	48 x 26 x 5	1200 x 650 x 125	E_NN-TOBS2648	538	823
	42 x 26 x 5	1050 x 650 x 125	E_NN-TOBS2642	518	804
	36 x 26 x 5	900 x 650 x 125	E_NN-TOBS2636	503	788
	24 x 26 x 5	600 x 650 x 125	E_NN-TOBS2624	495	772
	18 x 26 x 5	450 x 650 x 125	E_NN-TOBS2618	488	753
	Specify the surface type (1, 2).				

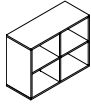
Open storage module	<i>Installs on a countertop. 2 adjustable shelves. 2 grommets. 1 tone only.</i>				
	48 x 20 x 36	1200 x 500 x 911	ENNN-M0483620	1,358	-

Open storage module	<i>Installs on a countertop. 1 adjustable shelf. 1 grommet. 1 tone only.</i>				
	24 x 20 x 36	600 x 500 x 911	ENNN-M0243620	1,114	-

WALL-MOUNTED SYSTEM FOR ACCESSORIES

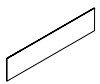
Laminate hanging systems	<i>5/8" (16 mm) thick laminate panel. Installation requires appropriate fastening hardware (not included) depending on wall type. 1 tone only.</i>				
	96 x 5/8 x 14	2400 x 16 x 356	ENNN-WMS96	488	-
	90 x 5/8 x 14	2250 x 16 x 356	ENNN-WMS90	477	-
	84 x 5/8 x 14	2100 x 16 x 356	ENNN-WMS84	469	-
	78 x 5/8 x 14	1950 x 16 x 356	ENNN-WMS78	462	-
	72 x 5/8 x 14	1800 x 16 x 356	ENNN-WMS72	454	-
	66 x 5/8 x 14	1650 x 16 x 356	ENNN-WMS66	444	-
	60 x 5/8 x 14	1500 x 16 x 356	ENNN-WMS60	434	-
	54 x 5/8 x 14	1350 x 16 x 356	ENNN-WMS54	426	-
	48 x 5/8 x 14	1200 x 16 x 356	ENNN-WMS48	418	-
	42 x 5/8 x 14	1050 x 16 x 356	ENNN-WMS42	412	-
	36 x 5/8 x 14	900 x 16 x 356	ENNN-WMS36	404	-
	30 x 5/8 x 14	750 x 16 x 356	ENNN-WMS30	394	-

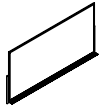
Porcelain white boards	<i>Porcelain magnetic surface for use with dry-erase markers. Pencil tray. Silver anodized aluminum frame. To be used with the Laminate hanging system (sold separately). 1 tone only.</i>				
	96 x 4 1/8 x 48	2400 x 104 x 1219	ENNS-WB9648	2,932	-
	72 x 4 1/8 x 48	1800 x 104 x 1219	ENNS-WB7248	2,347	-
	48 x 4 1/8 x 48	1200 x 104 x 1219	ENNS-WB4848	1,878	-
	96 x 4 1/8 x 42	2400 x 104 x 1067	ENNS-WB9642	2,859	-
	72 x 4 1/8 x 42	1800 x 104 x 1067	ENNS-WB7242	2,287	-
	48 x 4 1/8 x 42	1200 x 104 x 1067	ENNS-WB4842	1,830	-
	96 x 4 1/8 x 36	2400 x 104 x 914	ENNS-WB9636	2,790	-
	72 x 4 1/8 x 36	1800 x 104 x 914	ENNS-WB7236	2,230	-
	48 x 4 1/8 x 36	1200 x 104 x 914	ENNS-WB4836	1,785	-

Tackboards

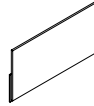

	W x D x H (")	W x D x H (mm)	Code	All Laminate (\$)	HPL Surfaces (\$)
<i>Natural cork. To be used with the Laminate hanging system (sold separately). 1 tone only.</i>					
	96 x 1 3/4 x 48	2400 x 44 x 1219	ENN_-TKC9648	1,370	-
	72 x 1 3/4 x 48	1800 x 44 x 1219	ENN_-TKC7248	1,184	-
	48 x 1 3/4 x 48	1200 x 44 x 1219	ENN_-TKC4848	1,006	-
	96 x 1 3/4 x 42	2400 x 44 x 1067	ENN_-TKC9642	1,281	-
	72 x 1 3/4 x 42	1800 x 44 x 1067	ENN_-TKC7242	1,123	-
	48 x 1 3/4 x 42	1200 x 44 x 1067	ENN_-TKC4842	963	-
	96 x 1 3/4 x 36	2400 x 44 x 914	ENN_-TKC9636	1,198	-
	72 x 1 3/4 x 36	1800 x 44 x 914	ENN_-TKC7236	1,056	-
	48 x 1 3/4 x 36	1200 x 44 x 914	ENN_-TKC4836	920	-

Specify the accent color (A, S).

Cabinets with laminate doors, 16" D



<i>Lock. To be used with the Laminate hanging system (sold separately). 1 tone only.</i>					
	36 x 16 x 48	900 x 400 x 1219	EN__-H364816P	1,887	-
	36 x 16 x 36	900 x 400 x 914	EN__-H363616P	1,837	-
	36 x 16 x 30	900 x 400 x 762	EN__-H363016P	1,794	-
	36 x 16 x 24	900 x 400 x 609	EN__-H362416P	1,751	-

Specify the handle code (L, Q, V). Specify the accent color (A, S).

48"-30" H:
2 adjustable shelves.
24" H:
1 adjustable shelf.

Cabinets with laminate door, 16" D

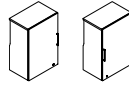

<i>Lock. To be used with the Laminate hanging system (sold separately). 1 tone only.</i>					
	24 x 16 x 48	600 x 400 x 1219	EN__-H244816PL	1,661	-
	24 x 16 x 48	600 x 400 x 1219	EN__-H244816PR	1,661	-
	24 x 16 x 36	600 x 400 x 914	EN__-H243616PL	1,619	-
	24 x 16 x 36	600 x 400 x 914	EN__-H243616PR	1,619	-
	24 x 16 x 30	600 x 400 x 762	EN__-H243016PL	1,579	-
	24 x 16 x 30	600 x 400 x 762	EN__-H243016PR	1,579	-
	24 x 16 x 24	600 x 400 x 609	EN__-H242416PL	1,534	-
	24 x 16 x 24	600 x 400 x 609	EN__-H242416PR	1,534	-
	18 x 16 x 48	450 x 400 x 1219	EN__-H184816PL	1,491	-
	18 x 16 x 48	450 x 400 x 1219	EN__-H184816PR	1,491	-
	18 x 16 x 36	450 x 400 x 914	EN__-H183616PL	1,458	-
	18 x 16 x 36	450 x 400 x 914	EN__-H183616PR	1,458	-
	18 x 16 x 30	450 x 400 x 762	EN__-H183016PL	1,426	-
	18 x 16 x 30	450 x 400 x 762	EN__-H183016PR	1,426	-
	18 x 16 x 24	450 x 400 x 609	EN__-H182416PL	1,388	-
	18 x 16 x 24	450 x 400 x 609	EN__-H182416PR	1,388	-

Specify the handle code (Q, V). Specify the accent color (A, S).

Cabinets with laminate doors, 13" D



<i>Lock. To be used with the Laminate hanging system (sold separately). 1 tone only.</i>					
	36 x 13 x 48	900 x 325 x 1219	EN__-H364813P	1,851	-
	36 x 13 x 36	900 x 325 x 914	EN__-H363613P	1,801	-
	36 x 13 x 30	900 x 325 x 762	EN__-H363013P	1,758	-
	36 x 13 x 24	900 x 325 x 609	EN__-H362413P	1,720	-

Specify the handle code (L, Q, V). Specify the accent color (A, S).

48"-30" H:
2 adjustable shelves.
24" H:
1 adjustable shelf.

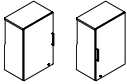
	W x D x H (")	W x D x H (mm)	Code	All Laminate (\$)	HPL Surfaces (\$)
Cabinets with laminate door, 13" D					
	<i>Lock. To be used with the Laminate hanging system (sold separately). 1 tone only.</i>				
	24 x 13 x 48	600 x 325 x 1219	EN__-H244813PL	1,627	—
	24 x 13 x 48	600 x 325 x 1219	EN__-H244813PR	1,627	—
	24 x 13 x 36	600 x 325 x 914	EN__-H243613PL	1,586	—
	24 x 13 x 36	600 x 325 x 914	EN__-H243613PR	1,586	—
	24 x 13 x 30	600 x 325 x 762	EN__-H243013PL	1,541	—
	24 x 13 x 30	600 x 325 x 762	EN__-H243013PR	1,541	—
	24 x 13 x 24	600 x 325 x 609	EN__-H242413PL	1,503	—
	24 x 13 x 24	600 x 325 x 609	EN__-H242413PR	1,503	—
	18 x 13 x 48	450 x 325 x 1219	EN__-H184813PL	1,458	—
	18 x 13 x 48	450 x 325 x 1219	EN__-H184813PR	1,458	—
	18 x 13 x 36	450 x 325 x 914	EN__-H183613PL	1,426	—
	18 x 13 x 36	450 x 325 x 914	EN__-H183613PR	1,426	—
	18 x 13 x 30	450 x 325 x 762	EN__-H183013PL	1,388	—
	18 x 13 x 30	450 x 325 x 762	EN__-H183013PR	1,388	—
	18 x 13 x 24	450 x 325 x 609	EN__-H182413PL	1,358	—
	18 x 13 x 24	450 x 325 x 609	EN__-H182413PR	1,358	—

48"-30" H:
2 adjustable shelves.
24" H:
1 adjustable shelf.
L at the end of the code: opens left.
R at the end of the code: opens right.

Specify the handle code (Q, V). Specify the accent color (A, S).

	W x D x H (")	W x D x H (mm)	Code	All Laminate (\$)	HPL Surfaces (\$)
Cabinets with translucent doors, 16" D					
	<i>With Silver anodized frame doors and translucent insert. Lock. To be used with the Laminate hanging system (sold separately). 1 tone only.</i>				
	36 x 16 x 48	900 x 400 x 1219	EN_S-H364816T	2,306	—
	36 x 16 x 36	900 x 400 x 914	EN_S-H363616T	2,254	—
	36 x 16 x 30	900 x 400 x 762	EN_S-H363016T	2,214	—
	36 x 16 x 24	900 x 400 x 609	EN_S-H362416T	2,170	—

48"-30" H:
2 adjustable shelves.
24" H:
1 adjustable shelf.

Specify the handle code (Q, V).

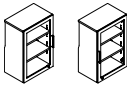
	W x D x H (")	W x D x H (mm)	Code	All Laminate (\$)	HPL Surfaces (\$)
Cabinets with translucent door, 16" D					
	<i>With Silver anodized frame door and translucent insert. Lock. To be used with the Laminate hanging system (sold separately). 1 tone only.</i>				
	24 x 16 x 48	600 x 400 x 1219	EN_S-H244816TL	1,870	—
	24 x 16 x 48	600 x 400 x 1219	EN_S-H244816TR	1,870	—
	24 x 16 x 36	600 x 400 x 914	EN_S-H243616TL	1,830	—
	24 x 16 x 36	600 x 400 x 914	EN_S-H243616TR	1,830	—
	24 x 16 x 30	600 x 400 x 762	EN_S-H243016TL	1,785	—
	24 x 16 x 30	600 x 400 x 762	EN_S-H243016TR	1,785	—
	24 x 16 x 24	600 x 400 x 609	EN_S-H242416TL	1,743	—
	24 x 16 x 24	600 x 400 x 609	EN_S-H242416TR	1,743	—
	18 x 16 x 48	450 x 400 x 1219	EN_S-H184816TL	1,700	—
	18 x 16 x 48	450 x 400 x 1219	EN_S-H184816TR	1,700	—
	18 x 16 x 36	450 x 400 x 914	EN_S-H183616TL	1,669	—
	18 x 16 x 36	450 x 400 x 914	EN_S-H183616TR	1,669	—
	18 x 16 x 30	450 x 400 x 762	EN_S-H183016TL	1,635	—
	18 x 16 x 30	450 x 400 x 762	EN_S-H183016TR	1,635	—
	18 x 16 x 24	450 x 400 x 609	EN_S-H182416TL	1,600	—
	18 x 16 x 24	450 x 400 x 609	EN_S-H182416TR	1,600	—

48"-30" H:
2 adjustable shelves.
24" H:
1 adjustable shelf.
L at the end of the code: opens left.
R at the end of the code: opens right.

Specify the handle code (Q, V).

	W x D x H (")	W x D x H (mm)	Code	All Laminate (\$)	HPL Surfaces (\$)
Cabinets with translucent doors, 13" D					
	<i>With Silver anodized frame doors and translucent insert. Lock. To be used with the Laminate hanging system (sold separately). 1 tone only.</i>				
	36 x 13 x 48	900 x 325 x 1219	EN_S-H364813T	2,271	—
	36 x 13 x 36	900 x 325 x 914	EN_S-H363613T	2,220	—
	36 x 13 x 30	900 x 325 x 762	EN_S-H363013T	2,179	—
	36 x 13 x 24	900 x 325 x 609	EN_S-H362413T	2,139	—

48"-30" H:
2 adjustable shelves.
24" H:
1 adjustable shelf.

Specify the handle code (Q, V).

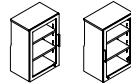
	W x D x H (")	W x D x H (mm)	Code	All Laminate (\$)	HPL Surfaces (\$)
Cabinets with translucent door, 13" D					
	<i>With Silver anodized frame door and translucent insert. Lock. To be used with the Laminate hanging system (sold separately). 1 tone only.</i>				
	24 x 13 x 48	600 x 325 x 1219	EN_S-H244813TL	1,837	—
	24 x 13 x 48	600 x 325 x 1219	EN_S-H244813TR	1,837	—
	24 x 13 x 36	600 x 325 x 914	EN_S-H243613TL	1,794	—
	24 x 13 x 36	600 x 325 x 914	EN_S-H243613TR	1,794	—
	24 x 13 x 30	600 x 325 x 762	EN_S-H243013TL	1,751	—
	24 x 13 x 30	600 x 325 x 762	EN_S-H243013TR	1,751	—
	24 x 13 x 24	600 x 325 x 609	EN_S-H242413TL	1,706	—
	24 x 13 x 24	600 x 325 x 609	EN_S-H242413TR	1,706	—
	18 x 13 x 48	450 x 325 x 1219	EN_S-H184813TL	1,669	—
	18 x 13 x 48	450 x 325 x 1219	EN_S-H184813TR	1,669	—
	18 x 13 x 36	450 x 325 x 914	EN_S-H183613TL	1,635	—
	18 x 13 x 36	450 x 325 x 914	EN_S-H183613TR	1,635	—
	18 x 13 x 30	450 x 325 x 762	EN_S-H183013TL	1,600	—
	18 x 13 x 30	450 x 325 x 762	EN_S-H183013TR	1,600	—
	18 x 13 x 24	450 x 325 x 609	EN_S-H182413TL	1,566	—
	18 x 13 x 24	450 x 325 x 609	EN_S-H182413TR	1,566	—

48"-30" H:
2 adjustable shelves.
24" H:
1 adjustable shelf.
L at the end of the code: opens left.
R at the end of the code: opens right.

Specify the handle code (Q, V).

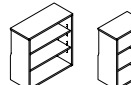
	W x D x H (")	W x D x H (mm)	Code	All Laminate (\$)	HPL Surfaces (\$)
Open cabinets, 16" D					
	<i>To be used with the Laminate hanging system (sold separately). 1 tone only.</i>				
	36 x 16 x 48	900 x 400 x 1219	ENN_-H364816	1,550	—
	24 x 16 x 48	600 x 400 x 1219	ENN_-H244816	1,491	—
	18 x 16 x 48	450 x 400 x 1219	ENN_-H184816	1,325	—
	36 x 16 x 36	900 x 400 x 914	ENN_-H363616	1,503	—
	24 x 16 x 36	600 x 400 x 914	ENN_-H243616	1,451	—
	18 x 16 x 36	450 x 400 x 914	ENN_-H183616	1,292	—
	36 x 16 x 30	900 x 400 x 762	ENN_-H363016	1,458	—
	24 x 16 x 30	600 x 400 x 762	ENN_-H243016	1,409	—
	18 x 16 x 30	450 x 400 x 762	ENN_-H183016	1,259	—
	36 x 16 x 24	900 x 400 x 609	ENN_-H362416	1,419	—
	24 x 16 x 24	600 x 400 x 609	ENN_-H242416	1,370	—
	18 x 16 x 24	450 x 400 x 609	ENN_-H182416	1,223	—

48" to 30" H:
2 adjustable shelves.
24" H:
1 adjustable shelf.

Specify the accent color (A, S).

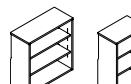
	W x D x H (")	W x D x H (mm)	Code	All Laminate (\$)	HPL Surfaces (\$)
Open cabinets, 13" D					
	<i>To be used with the Laminate hanging system (sold separately). 1 tone only.</i>				
	36 x 13 x 48	900 x 325 x 1219	ENN_-H364813	1,534	—
	24 x 13 x 48	600 x 325 x 1219	ENN_-H244813	1,476	—
	18 x 13 x 48	450 x 325 x 1219	ENN_-H184813	1,306	—
	36 x 13 x 36	900 x 325 x 914	ENN_-H363613	1,483	—
	24 x 13 x 36	600 x 325 x 914	ENN_-H243613	1,434	—
	18 x 13 x 36	450 x 325 x 914	ENN_-H183613	1,274	—
	36 x 13 x 30	900 x 325 x 762	ENN_-H363013	1,439	—
	24 x 13 x 30	600 x 325 x 762	ENN_-H243013	1,388	—
	18 x 13 x 30	450 x 325 x 762	ENN_-H183013	1,241	—
	36 x 13 x 24	900 x 325 x 609	ENN_-H362413	1,399	—
	24 x 13 x 24	600 x 325 x 609	ENN_-H242413	1,350	—
	18 x 13 x 24	450 x 325 x 609	ENN_-H182413	1,207	—

48" to 30" H:
2 adjustable shelves.
24" H:
1 adjustable shelf.

Specify the accent color (A, S).

W x D x H (")	W x D x H (mm)	Code	All Laminate (\$)	HPL Surfaces (\$)
---------------	----------------	------	-------------------	-------------------

SHELVINGS

Thermofused laminate frame. Levelers with 1½" (38 mm) height adjustment. Shelves: 18-gauge steel, Anthracite grey paint, load capacity 150 lbs (86 kg). Anti-tip shelves can be individually positioned flat or angled at 45° for display. Shelves are packaged separately.

Single-sided shelvings – open back

Single-faced shelvings must be anchored to a wall for safety and stability.

Starter

37 x 14 x 84	925 x 344 x 2130	E5NN-BOS1484	2,110	–
37 x 14 x 72	925 x 344 x 1825	E5NN-BOS1472	1,912	–
37 x 14 x 60	925 x 344 x 1520	E5NN-BOS1460	1,676	–

Add-on

Height must be equal to the starter unit.

36 x 14 x 84	900 x 344 x 2130	E5NN-BOA1484	1,944	–
36 x 14 x 72	900 x 344 x 1825	E5NN-BOA1472	1,736	–
36 x 14 x 60	900 x 344 x 1520	E5NN-BOA1460	1,476	–

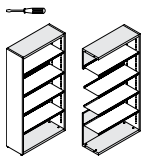

Starter Add-on
84" H:
5 adjustable shelves.
72" H:
4 adjustable shelves.
60" H:
3 adjustable shelves.

Single-sided shelvings – closed back

Single-faced shelvings must be anchored to a wall for safety and stability.

Starter

37 x 14 x 84	925 x 344 x 2130	E5NN-BCS1484	2,331	–
37 x 14 x 72	925 x 344 x 1825	E5NN-BCS1472	2,120	–
37 x 14 x 60	925 x 344 x 1520	E5NN-BCS1460	1,837	–
37 x 14 x 48	925 x 344 x 1215	E5NN-BCS1448	1,451	–
37 x 14 x 42	925 x 344 x 1063	E5NN-BCS1442	1,325	–

Add-on

Height must be equal to the starter unit.

36 x 14 x 84	900 x 344 x 2130	E5NN-BCA1484	2,110	–
36 x 14 x 72	900 x 344 x 1825	E5NN-BCA1472	1,887	–
36 x 14 x 60	900 x 344 x 1520	E5NN-BCA1460	1,591	–
36 x 14 x 48	900 x 344 x 1215	E5NN-BCA1448	1,306	–
36 x 14 x 42	900 x 344 x 1063	E5NN-BCA1442	1,223	–

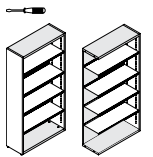

Starter Add-on
84" H:
5 adjustable shelves.
72" H:
4 adjustable shelves.
60" H:
3 adjustable shelves.
48" H-42" H:
2 adjustable shelves.

Double-sided shelvings – open back

Starter

37 x 26 x 84	925 x 665 x 2130	E5NN-BOS2684	3,587	–
37 x 26 x 72	925 x 665 x 1825	E5NN-BOS2672	3,151	–
37 x 26 x 60	925 x 665 x 1520	E5NN-BOS2660	2,719	–

Add-on

Height must be equal to the starter unit.

36 x 26 x 84	900 x 665 x 2130	E5NN-BOA2684	3,213	–
36 x 26 x 72	900 x 665 x 1825	E5NN-BOA2672	2,833	–
36 x 26 x 60	900 x 665 x 1520	E5NN-BOA2660	2,456	–

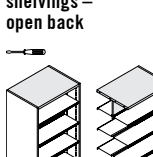

Starter Add-on
84" H:
10 adjustable shelves.
72" H:
8 adjustable shelves.
60" H:
6 adjustable shelves.

Double-sided shelvings – closed back

Starter

37 x 26 x 84	925 x 665 x 2130	E5NN-BCS2684	3,773	–
37 x 26 x 72	925 x 665 x 1825	E5NN-BCS2672	3,337	–
37 x 26 x 60	925 x 665 x 1520	E5NN-BCS2660	2,901	–

Add-on

Height must be equal to the starter unit.

36 x 26 x 84	900 x 665 x 2130	E5NN-BCA2684	3,327	–
36 x 26 x 72	900 x 665 x 1825	E5NN-BCA2672	2,932	–
36 x 26 x 60	900 x 665 x 1520	E5NN-BCA2660	2,497	–
36 x 26 x 48	900 x 665 x 1215	E5NN-BCA2648	2,062	–
36 x 26 x 42	900 x 665 x 1063	E5NN-BCA2642	1,957	–



Starter Add-on
84" H:
10 adjustable shelves.
72" H:
8 adjustable shelves.
60" H:
6 adjustable shelves.

W x D x H (")	W x D x H (mm)	Code	All Laminate (\$)	HPL Surfaces (\$)
---------------	----------------	------	-------------------	-------------------

Double-sided shelvings – closed back

Starter

37 x 26 x 84	925 x 665 x 2130	E5NN-BCS2684	3,703	–
37 x 26 x 72	925 x 665 x 1825	E5NN-BCS2672	3,269	–
37 x 26 x 60	925 x 665 x 1520	E5NN-BCS2660	2,775	–
37 x 26 x 48	925 x 665 x 1215	E5NN-BCS2648	2,347	–
37 x 26 x 42	925 x 665 x 1063	E5NN-BCS2642	2,230	–

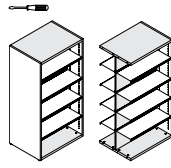

Starter Add-on
84" H:
10 adjustable shelves.
72" H:
8 adjustable shelves.
60" H:
6 adjustable shelves.
48" H-42" H:
4 adjustable shelves.

Add-on

Height must be equal to the starter unit.

36 x 26 x 84	900 x 665 x 2130	E5NN-BCA2684	3,327	–
36 x 26 x 72	900 x 665 x 1825	E5NN-BCA2672	2,932	–
36 x 26 x 60	900 x 665 x 1520	E5NN-BCA2660	2,497	–
36 x 26 x 48	900 x 665 x 1215	E5NN-BCA2648	2,062	–
36 x 26 x 42	900 x 665 x 1063	E5NN-BCA2642	1,957	–

Additional shelf

Anthracite grey 18-gauge steel with anti-tip device. Shelf can be positioned flat or angled for display.

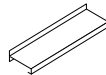

35 x 12 x 2	873 x 308 x 51	ENNN-BSHM	166	–
-------------	----------------	------------------	------------	---

Wire supports for books

Steel. Installs under the shelves.

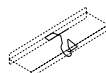

Package of 2.

8 ½ x 13 x 9	210 x 330 x 225	ENNN-BDIVM2	141	–
--------------	-----------------	--------------------	------------	---

Package of 10.

8 ½ x 13 x 9	210 x 330 x 225	ENNN-BDIVM10	426	–
--------------	-----------------	---------------------	------------	---

Mobile book cart

2 double-faced slanted shelves. 1 fixed flat shelf. 4 swivel casters, 2 with brakes. Lower and middle shelf clearance 10 13/16".



30 x 18 x 36	750 x 450 x 911	ENNN-MA183036	1,957	–
--------------	-----------------	----------------------	--------------	---

Specify the accent color (A, S).

CIRCULATION DESKS – 39" H

Full height 2-tone modesty panel. Levelers with 1½" (38 mm) height adjustment. All side panels come with wire access unless otherwise specified. End panel (ENNN-GFP2839) may be required to complete a circulation desk layout.

Rectangular counters

84 x 28 x 39	2100 x 700 x 987	E_N_-G288439	1,503	1,736
78 x 28 x 39	1950 x 700 x 987	E_N_-G287839	1,458	1,693
72 x 28 x 39	1800 x 700 x 987	E_N_-G287239	1,409	1,635
66 x 28 x 39	1650 x 700 x 987	E_N_-G286639	1,382	1,600
60 x 28 x 39	1500 x 700 x 987	E_N_-G286039	1,358	1,579
54 x 28 x 39	1350 x 700 x 987	E_N_-G285439	1,325	1,534
48 x 28 x 39	1200 x 700 x 987	E_N_-G284839	1,299	1,510
42 x 28 x 39	1050 x 700 x 987	E_N_-G284239	1,268	1,467
36 x 28 x 39	900 x 700 x 987	E_N_-G283639	1,241	1,439

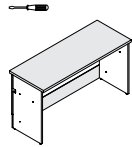

Surface grommet option, add H at the end of the code.
84" to 48": 2 grommets.
42" to 36": 1 grommet.

Specify the surface type (1, 2). Grommet option, specify the accent color (A, S) or specify N for no grommet.

84" to 78": Packaged in 2 boxes.

84 x 28 x 39½	2100 x 700 x 1000	E_N_-G288439	1,600	1,851
78 x 28 x 39½	1950 x 700 x 1000	E_N_-G287839	1,559	1,808
72 x 28 x 39½	1800 x 700 x 1000	E_N_-G287239	1,526	1,770
66 x 28 x 39½	1650 x 700 x 1000	E_N_-G286639	1,483	1,726
60 x 28 x 39½	1500 x 700 x 1000	E_N_-G286039	1,451	1,676
54 x 28 x 39½	1350 x 700 x 1000	E_N_-G285439	1,399	1,627
48 x 28 x 39½	1200 x 700 x 1000	E_N_-G284839	1,375	1,591
42 x 28 x 39½	1050 x 700 x 1000	E_N_-G284239	1,341	1,559
36 x 28 x 39½	900 x 700 x 1000	E_N_-G283639	1,315	1,526

Specify the surface type (5, 6). Grommet option, specify the accent color (A, S) or specify N for no grommet.

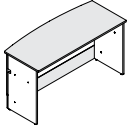
	W x D x H (")	W x D x H (mm)	Code	All Laminate (\$)	HPL Surfaces (\$)
Bow front counters	84 x 31 x 39	2100 x 775 x 987	E_N_-G288439A	1,736	2,011
	78 x 31 x 39	1950 x 775 x 987	E_N_-G287839A	1,693	1,968
	72 x 31 x 39	1800 x 775 x 987	E_N_-G287239A	1,635	1,902
	66 x 31 x 39	1650 x 775 x 987	E_N_-G286639A	1,600	1,851
	60 x 31 x 39	1500 x 775 x 987	E_N_-G286039A	1,579	1,830
	54 x 31 x 39	1350 x 775 x 987	E_N_-G285439A	1,534	1,777
	48 x 31 x 39	1200 x 775 x 987	E_N_-G284839A	1,510	1,743
	42 x 31 x 39	1050 x 775 x 987	E_N_-G284239A	1,467	1,700
	36 x 31 x 39	900 x 775 x 987	E_N_-G283639A	1,439	1,669
	Specify the surface type (1, 2). Grommet option, specify the accent color (A, S) or specify N for no grommet.				
	84 x 31 x 39½	2100 x 775 x 1000	E_N_-G288439A	1,851	2,154
	78 x 31 x 39½	1950 x 775 x 1000	E_N_-G287839A	1,808	2,103
	72 x 31 x 39½	1800 x 775 x 1000	E_N_-G287239A	1,770	2,053
	66 x 31 x 39½	1650 x 775 x 1000	E_N_-G286639A	1,726	1,995
	60 x 31 x 39½	1500 x 775 x 1000	E_N_-G286039A	1,676	1,944
	54 x 31 x 39½	1350 x 775 x 1000	E_N_-G285439A	1,627	1,894
	48 x 31 x 39½	1200 x 775 x 1000	E_N_-G284839A	1,591	1,843
	42 x 31 x 39½	1050 x 775 x 1000	E_N_-G284239A	1,559	1,808
	36 x 31 x 39½	900 x 775 x 1000	E_N_-G283639A	1,526	1,770
	Specify the surface type (5, 6). Grommet option, specify the accent color (A, S) or specify N for no grommet.				

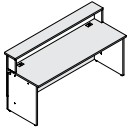
	9" (228 mm) deep transaction shelf. Grommet.				
Reception desks	84 x 28 x 39	2100 x 700 x 987	E_N_-GS2884H	1,720	1,944
	78 x 28 x 39	1950 x 700 x 987	E_N_-GS2878H	1,676	1,902
	72 x 28 x 39	1800 x 700 x 987	E_N_-GS2872H	1,635	1,851
	66 x 28 x 39	1650 x 700 x 987	E_N_-GS2866H	1,608	1,819
	60 x 28 x 39	1500 x 700 x 987	E_N_-GS2860H	1,586	1,794
	54 x 28 x 39	1350 x 700 x 987	E_N_-GS2854H	1,550	1,751
	48 x 28 x 39	1200 x 700 x 987	E_N_-GS2848H	1,526	1,726
	42 x 28 x 39	1050 x 700 x 987	E_N_-GS2842H	1,503	1,686
	36 x 28 x 39	900 x 700 x 987	E_N_-GS2836H	1,467	1,661
	Specify the surface type (1, 2). Specify the accent color (A, S).				
	84 x 28 x 39½	2100 x 700 x 1000	E_N_-GS2884H	1,819	2,062
	78 x 28 x 39½	1950 x 700 x 1000	E_N_-GS2878H	1,777	2,020
	72 x 28 x 39½	1800 x 700 x 1000	E_N_-GS2872H	1,743	1,980
	66 x 28 x 39½	1650 x 700 x 1000	E_N_-GS2866H	1,700	1,938
	60 x 28 x 39½	1500 x 700 x 1000	E_N_-GS2860H	1,669	1,887
	54 x 28 x 39½	1350 x 700 x 1000	E_N_-GS2854H	1,627	1,843
	48 x 28 x 39½	1200 x 700 x 1000	E_N_-GS2848H	1,600	1,808
	42 x 28 x 39½	1050 x 700 x 1000	E_N_-GS2842H	1,579	1,777
	36 x 28 x 39½	900 x 700 x 1000	E_N_-GS2836H	1,541	1,743
	Specify the surface type (5, 6). Specify the accent color (A, S).				

84" to 48": 2 grommets.
42" to 36": 1 grommet.
84" to 54": Packaged in 2 boxes.

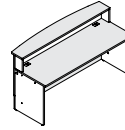
	W x D x H (")	W x D x H (mm)	Code	All Laminate (\$)	HPL Surfaces (\$)
Reception desks, bow transaction shelf	<i>13" (330 mm) deep bow front transaction shelf. Grommet.</i>				
	84 x 31 x 39	2100 x 775 x 987	E_N_-GS2884AH	1,843	2,088
	78 x 31 x 39	1950 x 775 x 987	E_N_-GS2878AH	1,801	2,046
	72 x 31 x 39	1800 x 775 x 987	E_N_-GS2872AH	1,758	1,995
	66 x 31 x 39	1650 x 775 x 987	E_N_-GS2866AH	1,736	1,952
	60 x 31 x 39	1500 x 775 x 987	E_N_-GS2860AH	1,700	1,921
	54 x 31 x 39	1350 x 775 x 987	E_N_-GS2854AH	1,669	1,887
	48 x 31 x 39	1200 x 775 x 987	E_N_-GS2848AH	1,635	1,851
	42 x 31 x 39	1050 x 775 x 987	E_N_-GS2842AH	1,608	1,808
	36 x 31 x 39	900 x 775 x 987	E_N_-GS2836AH	1,586	1,777
	Specify the surface type (1, 2). Specify the accent color (A, S).				
	84 x 31 x 39½	2100 x 775 x 1000	E_N_-GS2884AH	1,952	2,214
	78 x 31 x 39½	1950 x 775 x 1000	E_N_-GS2878AH	1,912	2,170
	72 x 31 x 39½	1800 x 775 x 1000	E_N_-GS2872AH	1,878	2,129
	66 x 31 x 39½	1650 x 775 x 1000	E_N_-GS2866AH	1,837	2,068
	60 x 31 x 39½	1500 x 775 x 1000	E_N_-GS2860AH	1,794	2,028
	54 x 31 x 39½	1350 x 775 x 1000	E_N_-GS2854AH	1,751	1,986
	48 x 31 x 39½	1200 x 775 x 1000	E_N_-GS2848AH	1,726	1,944
	42 x 31 x 39½	1050 x 775 x 1000	E_N_-GS2842AH	1,686	1,912
	36 x 31 x 39½	900 x 775 x 1000	E_N_-GS2836AH	1,661	1,878
	Specify the surface type (5, 6). Specify the accent color (A, S).				

84" to 48": 2 grommets.
42" to 36": 1 grommet.
84" to 54": Packaged in 2 boxes.

CIRCULATION DESKS – 29" H

Full height 2-tone modesty panel. Levelers with 1½" (38 mm) height adjustment. All side panels come with wire access unless otherwise specified. End panel (ENNN-GFP2829) may be required to complete a circulation desk layout.

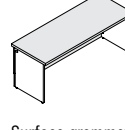
	Rectangular counters	W x D x H (")	W x D x H (mm)	Code	All Laminate (\$)	HPL Surfaces (\$)
	84 x 28 x 29	2100 x 700 x 735	E_N_-G288429	1,434	1,661	
	78 x 28 x 29	1950 x 700 x 735	E_N_-G287829	1,388	1,619	
	72 x 28 x 29	1800 x 700 x 735	E_N_-G287229	1,358	1,579	
	66 x 28 x 29	1650 x 700 x 735	E_N_-G286629	1,325	1,534	
	60 x 28 x 29	1500 x 700 x 735	E_N_-G286029	1,299	1,510	
	54 x 28 x 29	1350 x 700 x 735	E_N_-G285429	1,268	1,467	
	48 x 28 x 29	1200 x 700 x 735	E_N_-G284829	1,241	1,439	
	42 x 28 x 29	1050 x 700 x 735	E_N_-G284229	1,216	1,399	
	36 x 28 x 29	900 x 700 x 735	E_N_-G283629	1,184	1,375	
	Specify the surface type (1, 2). Grommet option, specify the accent color (A, S) or specify N for no grommet.					
	84 x 28 x 29½	2100 x 700 x 748	E_N_-G288429	1,534	1,777	
	78 x 28 x 29½	1950 x 700 x 748	E_N_-G287829	1,503	1,736	
	72 x 28 x 29½	1800 x 700 x 748	E_N_-G287229	1,458	1,693	
	66 x 28 x 29½	1650 x 700 x 748	E_N_-G286629	1,426	1,648	
	60 x 28 x 29½	1500 x 700 x 748	E_N_-G286029	1,382	1,600	
	54 x 28 x 29½	1350 x 700 x 748	E_N_-G285429	1,341	1,559	
	48 x 28 x 29½	1200 x 700 x 748	E_N_-G284829	1,315	1,526	
	42 x 28 x 29½	1050 x 700 x 748	E_N_-G284229	1,292	1,503	
	36 x 28 x 29½	900 x 700 x 748	E_N_-G283629	1,259	1,458	
	Specify the surface type (5, 6). Grommet option, specify the accent color (A, S) or specify N for no grommet.					

Surface grommet option, add H at the end of the code.
84" to 48": 2 grommets.
42" to 36": 1 grommet.

EDUCATIONAL FURNITURE

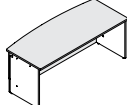
	W x D x H (")	W x D x H (mm)	Code	All Laminate (\$)	HPL Surfaces (\$)
Bow front counters 	84 x 31 x 29	2100 x 775 x 735	E_N_-G288429A	1,661	1,921
	78 x 31 x 29	1950 x 775 x 735	E_N_-G287829A	1,619	1,878
	72 x 31 x 29	1800 x 775 x 735	E_N_-G287229A	1,579	1,830
	66 x 31 x 29	1650 x 775 x 735	E_N_-G286629A	1,534	1,777
	60 x 31 x 29	1500 x 775 x 735	E_N_-G286029A	1,510	1,743
	54 x 31 x 29	1350 x 775 x 735	E_N_-G285429A	1,467	1,700
Surface grommet option, add H at the end of the code. 84" to 48": 2 grommets. 42" to 36": 1 grommet.	48 x 31 x 29	1200 x 775 x 735	E_N_-G284829A	1,439	1,669
	42 x 31 x 29	1050 x 775 x 735	E_N_-G284229A	1,399	1,627
	36 x 31 x 29	900 x 775 x 735	E_N_-G283629A	1,375	1,591
	Specify the surface type (1, 2). Grommet option, specify the accent color (A, S) or specify N for no grommet.				

84 x 31 x 29½	2100 x 775 x 748	E_N_-G288429A	1,777	2,062
78 x 31 x 29½	1950 x 775 x 748	E_N_-G287829A	1,736	2,011
72 x 31 x 29½	1800 x 775 x 748	E_N_-G287229A	1,693	1,968
66 x 31 x 29½	1650 x 775 x 748	E_N_-G286629A	1,648	1,912
60 x 31 x 29½	1500 x 775 x 748	E_N_-G286029A	1,600	1,851
54 x 31 x 29½	1350 x 775 x 748	E_N_-G285429A	1,559	1,808
48 x 31 x 29½	1200 x 775 x 748	E_N_-G284829A	1,526	1,770
42 x 31 x 29½	1050 x 775 x 748	E_N_-G284229A	1,503	1,736
36 x 31 x 29½	900 x 775 x 748	E_N_-G283629A	1,458	1,693
Specify the surface type (5, 6). Grommet option, specify the accent color (A, S) or specify N for no grommet.				

End panels 	1 panel. Reversible. Required to cover unused openings or to complete a circulation desk layout.			
1 x 28 x 42	25 x 700 x 1065	ENNN-GFP2839	361	-
1 x 28 x 32	25 x 700 x 815	ENNN-GFP2829	336	-

ADA rectangular counters, 32" H 	No wire access on side panel.			
36 x 28 x 32	900 x 700 x 813	E_NN-G283632	948	1,096
Specify the surface type (1, 2).				
36 x 28 x 32½	900 x 700 x 826	E_NN-G283632	998	1,159
Specify the surface type (5, 6).				

ADA bow front counters, 32" H 	No wire access on side panel.			
36 x 31 x 32	900 x 775 x 813	E_NN-G283632A	1,089	1,241
Specify the surface type (1, 2).				
36 x 31 x 32½	900 x 775 x 826	E_NN-G283632A	1,140	1,299
Specify the surface type (5, 6).				

Corner bookcase units, 39" H 	2 adjustable shelves. No wire access on side panel.			
28 x 28 x 39	700 x 700 x 987	E1NN-GB282839	1,370	-
1" (25 mm) thick laminate top.				
28 x 28 x 39½	700 x 700 x 1000	E5NN-GB282839	1,426	-
1½" (38 mm) thick laminate top.				

Corner bookcase units, 26" H 	1 adjustable shelf. No wire access on side panel.			
28 x 28 x 29	700 x 700 x 735	E1NN-GB282829	1,172	-
1" (25 mm) thick laminate top.				
28 x 28 x 29½	700 x 700 x 748	E5NN-GB282829	1,229	-
1½" (38 mm) thick laminate top.				

CIRCULATION DESK STORAGE UNITS – 39" H

Full height 2-tone modesty panel. Levelers with 1½" (38 mm) height adjustment. All side panels come with wire access unless otherwise specified. End panels (ENNN-GFP2839) may be required to complete a circulation desk layout.

	W x D x H (")	W x D x H (mm)	Code	All Laminate (\$)	HPL Surfaces (\$)
Bookcase units with doors 	<i>Bookcase with doors, 2 adjustable shelves. Lock.</i>				
	36 x 28 x 39	900 x 700 x 987	E___-G283639B	1,851	1,938
Specify the surface type (1, 2). Specify the handle code (L, Q, V). Specify the accent color (A, S).					
36 x 28 x 39½	900 x 700 x 1000	E___-G283639B	1,944	2,020	
Specify the surface type (5, 6). Specify the handle code (L, Q, V). Specify the accent color (A, S).					

Combined storage units 	2 box drawers. Bookcase with doors, 1 adjustable shelf. Locks.				
36 x 28 x 39	900 x 700 x 987	E___-G283639T	2,179	2,262	
Specify the surface type (1, 2). Specify the handle code (L, Q, V). Specify the accent color (A, S).					
36 x 28 x 39½	900 x 700 x 1000	E___-G283639T	2,271	2,372	
Specify the surface type (5, 6). Specify the handle code (L, Q, V). Specify the accent color (A, S).					

Combined storage units 	2 box drawers. 2 lateral file drawers with suspension bars. Interlock system. Locks.				
36 x 28 x 39	900 x 700 x 987	E___-G283639U	2,814	2,932	
Specify the surface type (1, 2). Specify the handle code (L, Q, V). Specify the accent color (A, S).					
36 x 28 x 39½	900 x 700 x 1000	E___-G283639U	2,859	2,993	
Specify the surface type (5, 6). Specify the handle code (L, Q, V). Specify the accent color (A, S).					

Open combined storage units 	1 open storage: 33¾" W x 23" D x 9¾" H (847 x 582 x 248 mm). 3 box drawers. 1 lateral file drawer with suspension bars. Locks.				
36 x 28 x 39	900 x 700 x 987	E___-GC283639	2,924	3,051	
Specify the surface type (1, 2). Specify the handle code (L, Q, V). Specify the accent color (A, S).					
36 x 28 x 39½	900 x 700 x 1000	E___-GC283639	2,984	3,111	
Specify the surface type (5, 6). Specify the handle code (L, Q, V). Specify the accent color (A, S).					

Open lateral file units 	1 open storage: 33¾" W x 23" D x 9¾" H (847 x 582 x 248 mm). 2 lateral file drawers with suspension bars. Interlock system. Lock.				
36 x 28 x 39	900 x 700 x 987	E___-GL283639	2,170	2,279	
Specify the surface type (1, 2). Specify the handle code (L, Q, V). Specify the accent color (A, S).					
36 x 28 x 39½	900 x 700 x 1000	E___-GL283639	2,214	2,347	
Specify the surface type (5, 6). Specify the handle code (L, Q, V). Specify the accent color (A, S).					

Storage units with drawers 	4 utility drawers. Interlock system. Lock.				
36 x 28 x 39	900 x 700 x 987	E___-GU283639	2,632	2,680	
Specify the surface type (1, 2). Specify the handle code (L, Q, V). Specify the accent color (A, S).					
36 x 28 x 39½	900 x 700 x 1000	E___-GU283639	2,750	2,814	
Specify the surface type (5, 6). Specify the handle code (L, Q, V). Specify the accent color (A, S).					

	W x D x H (")	W x D x H (mm)	Code	All Laminate (\$)	HPL Surfaces (\$)
Bookcase units	<i>2 adjustable shelves. Lock.</i>				
	36 x 28 x 39	900 x 700 x 987	E_NN-GB283639	1,608	1,726
	Specify the surface type (1, 2).				
	36 x 28 x 39½	900 x 700 x 1000	E_NN-GB283639	1,661	1,794
	Specify the surface type (5, 6).				

Lateral file units	<i>1 box drawer. 2 lateral file drawers with suspension bars. Interlock system. Lock.</i>				
	36 x 28 x 39	900 x 700 x 987	E___-GW283639	2,669	2,768
	Specify the surface type (1, 2). Specify the handle code (L, Q, V). Specify the accent color (A, S).				
	36 x 28 x 39½	900 x 700 x 1000	E___-GW283639	2,783	2,898
	Specify the surface type (5, 6). Specify the handle code (L, Q, V). Specify the accent color (A, S).				

Book return units	<i>Book slot opening: 14" W x 4" H (355 x 102 mm). Interior space: 33¼" W x 23" D x 37" H (847 x 582 x 940 mm).</i>				
	36 x 28 x 39	900 x 700 x 987	E_NN-GD283639	1,382	1,586
	Specify the surface type (1, 2).				
	36 x 28 x 39½	900 x 700 x 1000	E_NN-GD283639	1,458	1,669
	Specify the surface type (5, 6).				

Depressible book cart	<i>4 swivel casters, 2 with brakes. 1 tone only.</i>				
	31 x 22 x 29½	790 x 560 x 749	ENNN-GDBOX30	3,035	-

CIRCULATION DESK STORAGE UNITS – 29" H

Full height 2-tone modesty panel. Levelers with 1½" (38 mm) height adjustment. All side panels come with wire access unless otherwise specified. End panels (ENNN-GFP2829) may be required to complete a circulation desk layout.

Bookcase units with doors	<i>1 adjustable shelf. Lock.</i>				
	36 x 28 x 29	900 x 700 x 735	E___-G283629B	1,586	1,648
	Specify the surface type (1, 2). Specify the handle code (L, Q, V). Specify the accent color (A, S).				
	36 x 28 x 29½	900 x 700 x 748	E___-G283629B	1,661	1,726
	Specify the surface type (5, 6). Specify the handle code (L, Q, V). Specify the accent color (A, S).				

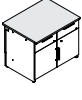
Combined storage units	<i>2 box drawers. Bookcase with doors, 1 adjustable shelf. Locks.</i>				
	36 x 28 x 29	900 x 700 x 735	E___-G283629T	1,995	2,068
	Specify the surface type (1, 2). Specify the handle code (L, Q, V). Specify the accent color (A, S).				
	36 x 28 x 29½	900 x 700 x 748	E___-G283629T	2,088	2,170
	Specify the surface type (5, 6). Specify the handle code (L, Q, V). Specify the accent color (A, S).				

Combined storage units	<i>3 box drawers. 1 lateral file drawer with suspension bars. Locks.</i>				
	36 x 28 x 29	900 x 700 x 735	E___-GC283629	2,641	2,768
	Specify the surface type (1, 2). Specify the handle code (L, Q, V). Specify the accent color (A, S).				
	36 x 28 x 29½	900 x 700 x 748	E___-GC283629	2,698	2,825
	Specify the surface type (5, 6). Specify the handle code (L, Q, V). Specify the accent color (A, S).				

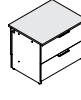
	W x D x H (")	W x D x H (mm)	Code	All Laminate (\$)	HPL Surfaces (\$)
Lateral file units	<i>2 lateral file drawers with suspension bars. Interlock system. Lock.</i>				
	36 x 28 x 29	900 x 700 x 735	E___-GL283629	1,887	2,011
	Specify the surface type (1, 2). Specify the handle code (L, Q, V). Specify the accent color (A, S).				
	36 x 28 x 29½	900 x 700 x 748	E___-GL283629	1,944	2,062
	Specify the surface type (5, 6). Specify the handle code (L, Q, V). Specify the accent color (A, S).				

Storage units with drawers	<i>4 utility drawers. Lock.</i>				
	36 x 28 x 29	900 x 700 x 735	E___-GU283629	2,497	2,615
	Specify the surface type (1, 2). Specify the handle code (L, Q, V). Specify the accent color (A, S).				
	36 x 28 x 29½	900 x 700 x 748	E___-GU283629	2,547	2,680
	Specify the surface type (5, 6). Specify the handle code (L, Q, V). Specify the accent color (A, S).				

Bookcase units	<i>1 adjustable shelf.</i>				
	36 x 28 x 29	900 x 700 x 735	E_NN-GB283629	1,451	1,550
	Specify the surface type (1, 2).				
	36 x 28 x 29½	900 x 700 x 748	E_NN-GB283629	1,503	1,608
	Specify the surface type (5, 6).				

BENCHES

Rectangular laminate benches	<i>Open storage space. Silver anodized aluminum feet. Can accommodate a cushion, order separately.</i>				
	48 x 20 x 20	1200 x 500 x 508	E1NS-BCH2048	864	-
	36 x 20 x 20	900 x 500 x 508	E1NS-BCH2036	810	-
	24 x 20 x 20	600 x 500 x 508	E1NS-BCH2024	696	-

Corner laminate bench	<i>Open storage space. Silver anodized aluminum feet. Must be attached to a rectangular laminate bench (E1NS-BCH20__).</i>				
	20 x 20 x 20	500 x 500 x 508	E1NS-BQR2020	664	-

Laminate magazine table	<i>Open storage space. Silver anodized aluminum feet.</i>				
	36 x 36 x 20	900 x 900 x 508	E1NS-STR3620	1,089	-

Cushions	<i>Installs on rectangular benches seat with Velcro. These prices are applicable for United Chair® Grade 1 and 2 standard fabrics. For other grades add: Grade 3: 15%, Grade 4: 20%, Grade 5: 25% and Grade 6: 30%.</i>				
	48 x 20 x 1½	1200 x 500 x 35	ENNN-CU2048	713	-
	36 x 20 x 1½	900 x 500 x 35	ENNN-CU2036	538	-
	24 x 20 x 1½	600 x 500 x 35	ENNN-CU2024	387	-
	All United Chair® standard fabrics, vinyls and leathers are available to coordinate on cushions.				
	Specify the fabric code after the product code.				

LOCKERS

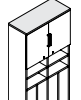
Storage cubbies with doors	<i>1 adjustable shelf. 8 hooks for clothes. Locks. Levelers with 1½" (38 mm) height adjustment. Single-faced shelvings must be anchored to a wall for safety and stability.</i>				
	36 x 15 x 84	900 x 375 x 2130	E1__-L153684P	2,680	-
	Specify the handle code (L, Q, V). Specify the accent color (A, S).				

EDUCATIONAL FURNITURE

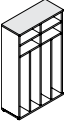
	W x D x H (")	W x D x H (mm)	Code	All Laminate (\$)	HPL Surfaces (\$)
Open storage cubbies	<i>8 hooks for clothes. Levelers with 1½" (38 mm) height adjustment.</i>				
	36 x 15 x 60	900 x 375 x 1520	E1NN-L153660	2,053	—

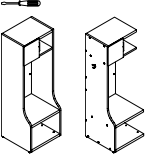
	W x D x H (")	W x D x H (mm)	Code	All Laminate (\$)	HPL Surfaces (\$)
Athletic lockers	<i>Open storage space. 1 door. 1½" (38 mm) thick integrated seat in thermofused laminate or high-pressure laminate. 2 hooks for clothes. Lock attachment included. Levelers with 1½" (38 mm) height adjustment. 1 tone only.</i>				
	Starter				
Starter	25 x 24 x 72	625 x 600 x 1825	E_N_-OLS2572P	2,287	2,383
Add-on	Add-on				
Add-on	24 x 24 x 72	600 x 600 x 1825	E_N_-OLA2472P	1,857	1,921

ACCESSORIES

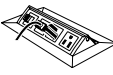
	W x D x H (")	W x D x H (mm)	Code	All Laminate (\$)	HPL Surfaces (\$)
Electrical/communication module	<i>Includes two electrical outlets. Can accommodate the couplers listed on page 177 of the Lacasse general list. 72" (1829 mm) cord included. Silver anodized aluminum. Field installed. UL and CUL certified. Adaptors included.</i>				
	8¼ x 4¾ x 3	212 x 110 x 75	LGC-PC2P	586	—

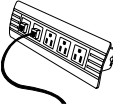
	W x D x H (")	W x D x H (mm)	Code	All Laminate (\$)	HPL Surfaces (\$)
Removable electrical/communication module	<i>3 electrical outlets. Can accommodate the couplers listed on page 177 of the Lacasse general list. 72" cord included. Silver anodized aluminum. UL and CUL certified.</i>				
	10 x 5½ x 3	255 x 140 x 75	LGC-PCS	518	—

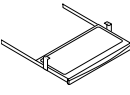
	W x D x H (")	W x D x H (mm)	Code	All Laminate (\$)	HPL Surfaces (\$)
Sliding keyboard trays	<i>Molded plastic on wood. Height adjustment 3", 3½", 4" (76, 89, 102 mm). Locks in extended position.</i>				
	28¾ x 15 x 3½	721 x 381 x 89	LGC-SKD27	294	—

	W x D x H (")	W x D x H (mm)	Code	All Laminate (\$)	HPL Surfaces (\$)
Horizontal wire channels	<i>Self-adhesive. Installs under the surface. Supports most power bars. Specify the plastic finish S Silver or A Anthracite grey.</i>				
	20 x 2¼ x 3¼	500 x 70 x 80	LGC-HWMC24_	114	—
	44 x 2¼ x 3¼	1100 x 70 x 80	LGC-HWMC48_	141	—
	68 x 2¼ x 3¼	1700 x 70 x 80	LGC-HWMC72_	166	—

	W x D x H (")	W x D x H (mm)	Code	All Laminate (\$)	HPL Surfaces (\$)
CPU holder	<i>Black metal CPU support. Mounts under a surface. Hardware included. Adjusts to CPU.</i>				
	5½ x 10 x 15	140 x 250 x 375	LGC-CCPU	244	—

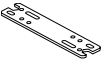
	W x D x H (")	W x D x H (mm)	Code	All Laminate (\$)	HPL Surfaces (\$)
Flush plates	<i>To link and level two surfaces. Package of 10. Black metal.</i>				
	7 x 1½ x 1⅞	175 x 38 x 3	LGC-FLP	93	—

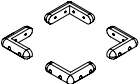
	W x D x H (")	W x D x H (mm)	Code	All Laminate (\$)	HPL Surfaces (\$)
Protective rubber bumpers	<i>For mobile units. Package of 4. Grey.</i>				
	3⅞ x 3⅞ x 1	76 x 76 x 25	LGC-BUMP	93	—

ELECTRIFICATION

	W x D x H (")	W x D x H (mm)	Code	All Laminate (\$)	HPL Surfaces (\$)
Duplex receptacles	<i>2 outlets. Black. Mounting bracket included.</i>				
	5½ x 1 x 5¾	142 x 25 x 146	LGC-4DUPLXC_	175	—

Specify circuit number at the end of the code (1, 2).

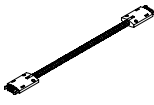
	W x D x H (")	W x D x H (mm)	Code	All Laminate (\$)	HPL Surfaces (\$)
Universal pass cables	<i>Connects 2 duplex receptacles.</i>				
	18	457	LGC-PASS18	175	—
	36	914	LGC-PASS36	201	—
	54	1372	LGC-PASS54	226	—
	72	1829	LGC-PASS72	252	—

	W x D x H (")	W x D x H (mm)	Code	All Laminate (\$)	HPL Surfaces (\$)
Electrical feeds	<i>72" (1829 mm) cable or 60" (1524 mm) long cable. Must be installed by an electrician.</i>				
	60	1524	LGC-FFEED60	327	—
	72	1829	LGC-FFEED72	329	—

2-TONE APPLICATION

TYPICAL TWO-TONE APPLICATION

SPECIFIC TWO-TONE APPLICATION

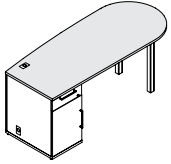
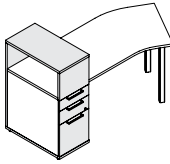
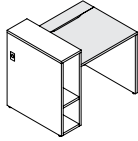
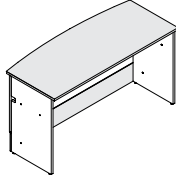
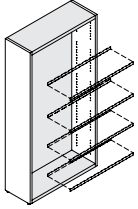
ALL PRODUCTS	LECTERN-DESKS	CPU TABLES	CIRCULATION DESKS	SHELVINGS
				
<p>The first finish specified will be applied to the top/surface of the unit.</p> <p>The second finish specified will be applied to the rest of the unit.</p>	<p>The first finish specified will be applied to the lectern top, front, base and drawers or doors of the unit.</p> <p>The second finish specified will be applied to the rest of the unit.</p>	<p>The first finish specified will be applied to the work surface of the unit.</p> <p>The second finish specified will be applied to the rest of the unit.</p>	<p>The first finish specified will be applied to the work surface and to the bottom portion of the modesty.</p> <p>The second finish specified will be applied to the rest of the unit.</p>	<p>The first finish specified will be applied to the top, base and back of the unit.</p> <p>The second finish specified will be applied to the rest of the unit.</p>

TYPICAL WOOD GRAIN DIRECTION FOR THINK SMART EDUCATIONAL FURNITURE

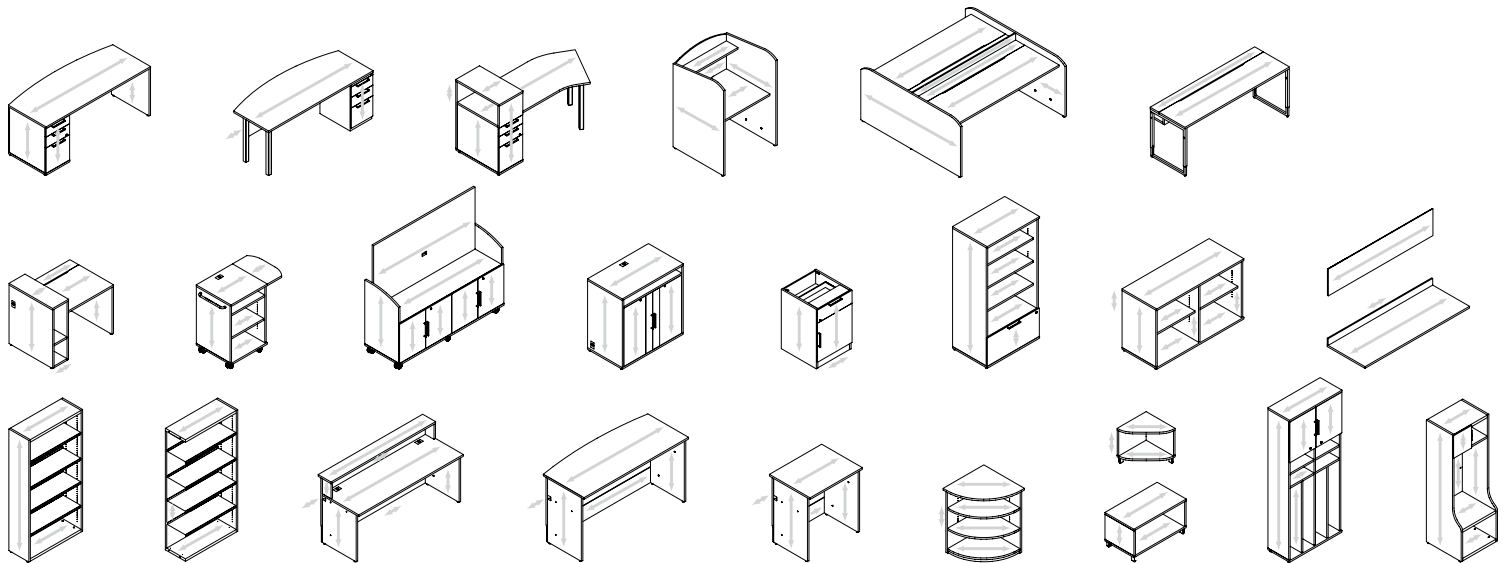

TECHNICAL PERFORMANCES

THERMOFUSED LAMINATE (TFL):

- Depending on the furniture collection, Lacasse casegoods have TFL surfaces and side panels made of particleboard panels of 1" (25.4 mm) or 1½" (38 mm) thick finished with a mar-resistant high-performance thermofused laminate (45 lbs/ft³). The particleboard panels are laminated on both sides for proper balance.
- TFL technology consists on a decorative paper impregnated with reactive melamine resins which is thermally fused to a substrate (particleboard). The heat and pressure produces a permanent thermal bond between the melamine resins, the decorative paper and the substrate. The bonding process results in a clear, hard and non-porous surface.
- TFL panels, unlike wood, will not gouge or dent.
- Delamination is not possible, due to the manufacturing process.
- TFL panels carry a 25-year warranty.

HIGH-PRESSURE LAMINATE (HPL):

- Certain collections are also available with HPL surfaces made of 1¼" (27 mm) or 1⅞" (40 mm) thick particleboard finished with high-pressure laminate (laminate plus a ½" [0.8 mm] black backing).
- HPL technology consists of multiple layers of Kraft paper saturated with phenolic resin, a decorative layer of paper saturated with melamine resin, and a very thin top sheet of heavily saturated melamine resin. The high-pressure laminate sheet is then glued to a substrate (particleboard).
- HPL panels offer a good wear and impact resistance.
- HPL panels carry a 5-year warranty.

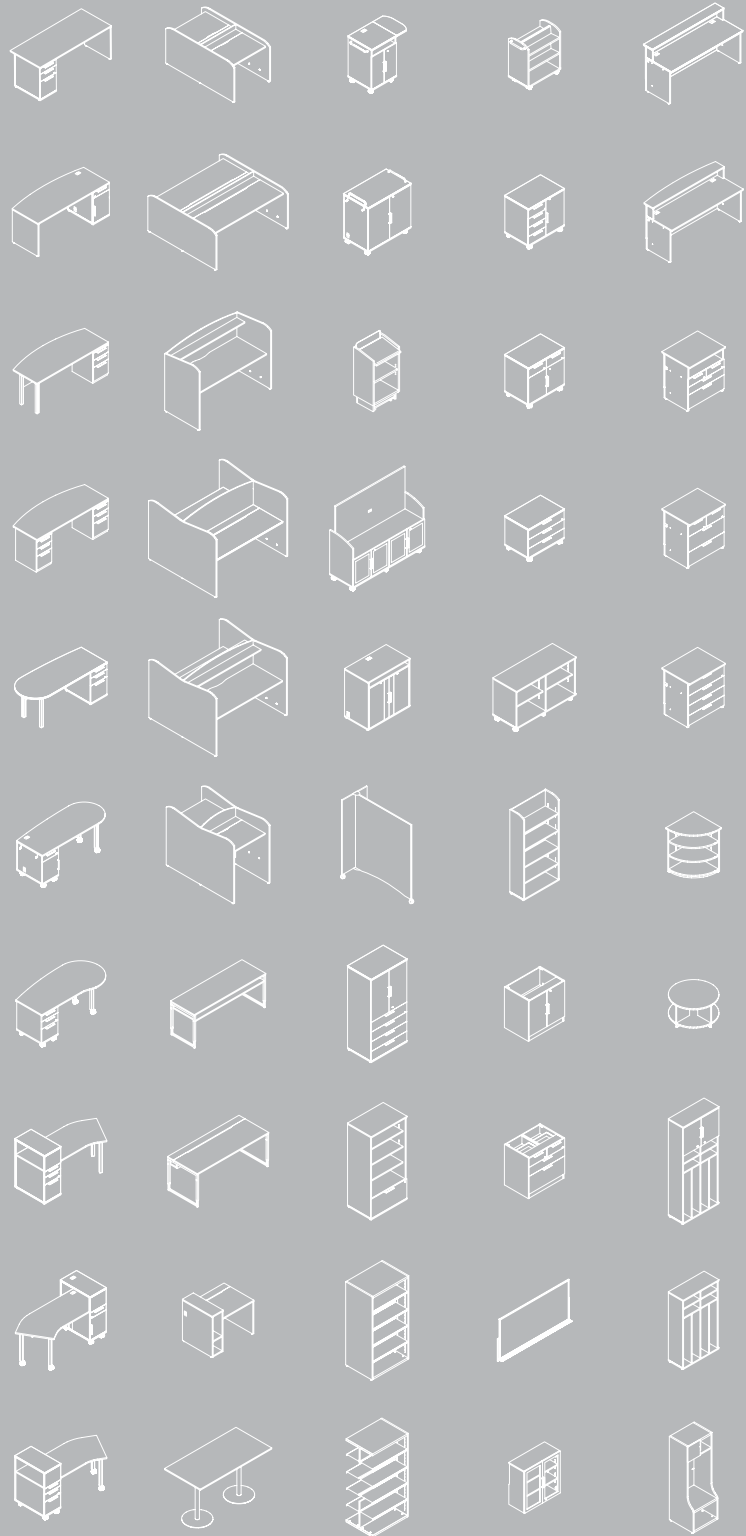

THE LEARNING ENVIRONMENT SOLUTION

Founded in 1956, Groupe Lacasse has manufacturing facilities throughout North America. We have the experience, expertise and capability to deliver incomparable design, exceptional quality, optimum service and outstanding value in Educational Furniture Solutions.

GROUPE
LACASSE

1-888-522-2773
www.groupelacasse.com



Think Smart has achieved GREENGUARD GOLD Certification.

GREENGUARD Certified products are certified to GREENGUARD standards for low chemical emissions into indoor air during product usage. For more information, visit ul.com/gg.