



Get Your Bespoke Office Design Today

We'll Get You The Right Office Furniture

Call Now (856)-368-9085

Call Now To Order (856) 368-9085

50% OFF Sale On Now

Nationwide Delivery and Installation

Office Doctor Discount Office Furniture

[www.OfficeDr.com](http://www.OfficeDr.com) 856-368-9085

Safco Sale On Now

Take 50% Off the List Prices in this PDF

**Call 856-368-9085 Now**

Free Layout & Design Service

Arc Rotary Files



The ARC™ Rotary File is a double faced unit that rotates easily to provide access to both sides. Using our flexible cantilever style shelving, the ARC provides the most unobstructed filing inches per level and the easiest installation possible. The Complete Starter includes everything needed to house a filing system including the specified number of shelves and dividers. See page 7 Corporate Color Program, paint colors and laminates or go to Safco website to view color swatches.

- Allow 5¼" (letter depth) or 6½" (legal depth) clearance from wall for rotating carriage
- Empty units can be configured in endless variations for mixed media storage solutions
- Alley clearance needed 36"
- Shelves adjust on 1½"H increments; 120 lb. weight capacity per shelf
- Complete Units are ideal for storing color-coded filing
- To order a fully assembled unit, add the letter "B" after the letter "C" in the part number (e.g. ARCB24403S)
- ARC top is unfinished. Work surfaces are available
- Complete units have slotted shelves with two (2) file dividers per 24" wide shelf; three (3) file dividers per 30" wide shelf
- S: Starter, A: Adder
- Standard Lock on all cabinets comes keyed alike
- Adder units attach to either right or left side of starter unit

**PRECONFIGURED IDEA STARTERS**

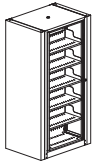

**GSA**

**6-Tier Complete**

**Letter (288 LFI)**

| Parent #  | W    | D    | H   | Wt. | Knockdown List Price | Assembled Model No. | Assembled List Price "B" |
|-----------|------|------|-----|-----|----------------------|---------------------|--------------------------|
| ARC24726S | 37¼" | 26¼" | 73" | 403 | 5,629.00             | ARCB24726S          | 6,418.00                 |
| ARC24726A | 31¾" | 26¼" | 73" | 347 | 5,162.00             | ARCB24726A          | 5,950.00                 |

**Legal (360 LFI)**

|           |      |      |     |     |          |            |          |
|-----------|------|------|-----|-----|----------|------------|----------|
| ARC30726S | 46"  | 32¼" | 73" | 542 | 7,113.00 | ARCB30726S | 7,910.00 |
| ARC30726A | 39¼" | 32¼" | 73" | 478 | 6,555.00 | ARCB30726A | 7,361.00 |

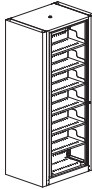

**GSA**

**7-Tier Complete**

**Letter (336 LFI)**

|           |      |      |      |     |          |            |          |
|-----------|------|------|------|-----|----------|------------|----------|
| ARC24827S | 37¼" | 26¼" | 83½" | 427 | 6,374.00 | ARCB24827S | 7,176.00 |
| ARC24827A | 31¾" | 26¼" | 83½" | 365 | 5,857.00 | ARCB24827A | 6,654.00 |

**Legal (420 LFI)**

|           |      |      |      |     |          |            |          |
|-----------|------|------|------|-----|----------|------------|----------|
| ARC30827S | 46"  | 32¼" | 83½" | 588 | 7,905.00 | ARCB30827S | 8,693.00 |
| ARC30827A | 39¼" | 32¼" | 83½" | 516 | 7,131.00 | ARCB30827A | 8,066.00 |

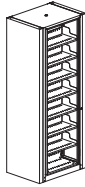

**GSA**

**8-Tier Complete**

**Letter (384 LFI)**

|           |      |      |     |     |          |     |     |
|-----------|------|------|-----|-----|----------|-----|-----|
| ARC24938S | 37¼" | 26¼" | 94" | 478 | 7,153.00 | N/A | N/A |
| ARC24938A | 31¾" | 26¼" | 94" | 408 | 6,592.00 | N/A | N/A |

**Legal (480 LFI)**

|           |      |      |     |     |          |     |     |
|-----------|------|------|-----|-----|----------|-----|-----|
| ARC30938S | 46"  | 32¼" | 94" | 632 | 8,726.00 | N/A | N/A |
| ARC30938A | 39¼" | 32¼" | 94" | 550 | 8,117.00 | N/A | N/A |

**ARC™ ROTARY FILE - EMPTY CABINET**

See page 7 for Safco Corporate Color Program, Laminates and Paint colors or go to Safco website to view color swatches. Contact your local Safco Sales Rep Group to discuss space planning specific application, obtain prior approval and quote.



**GSA**

**6-Tier Empty**

**Letter**

|            |      |      |     |     |          |             |          |
|------------|------|------|-----|-----|----------|-------------|----------|
| ARC24726ES | 37¼" | 26¼" | 73" | 303 | 4,381.00 | ARCB24726ES | 5,154.00 |
| ARC24726EA | 31¾" | 26¼" | 73" | 247 | 3,929.00 | ARCB24726EA | 4,798.00 |

**Legal**

|            |      |      |     |     |          |             |          |
|------------|------|------|-----|-----|----------|-------------|----------|
| ARC30726ES | 46"  | 32¼" | 73" | 399 | 5,403.00 | ARCB30726ES | 6,306.00 |
| ARC30726EA | 39¼" | 32¼" | 73" | 335 | 4,958.00 | ARCB30726EA | 5,757.00 |



**GSA**

**7-Tier Empty**

**Letter**

|            |      |      |      |     |          |             |          |
|------------|------|------|------|-----|----------|-------------|----------|
| ARC24827ES | 37¼" | 26¼" | 83½" | 323 | 5,010.00 | ARCB24827ES | 5,640.00 |
| ARC24827EA | 31¾" | 26¼" | 83½" | 261 | 4,495.00 | ARCB24827EA | 5,137.00 |

**Legal**

|            |      |      |      |     |          |             |          |
|------------|------|------|------|-----|----------|-------------|----------|
| ARC30827ES | 46"  | 32¼" | 83½" | 423 | 6,049.00 | ARCB30827ES | 6,767.00 |
| ARC30827EA | 39¼" | 32¼" | 83½" | 351 | 5,450.00 | ARCB30827EA | 6,174.00 |

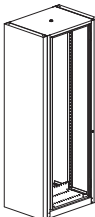

**GSA**

**8-Tier Empty**

**Letter**

|            |      |      |     |     |          |     |     |
|------------|------|------|-----|-----|----------|-----|-----|
| ARC24938ES | 37¼" | 26¼" | 94" | 345 | 5,579.00 | N/A | N/A |
| ARC24938EA | 31¾" | 26¼" | 94" | 275 | 5,034.00 | N/A | N/A |

**Legal**

|            |      |      |     |     |          |     |     |
|------------|------|------|-----|-----|----------|-----|-----|
| ARC30938ES | 46"  | 32¼" | 94" | 437 | 6,781.00 | N/A | N/A |
| ARC30938EA | 39¼" | 32¼" | 94" | 355 | 6,053.00 | N/A | N/A |

• Not available assembled

Contact your local Safco Sales Rep Group to discuss space planning specific application, obtain prior approval and quote.

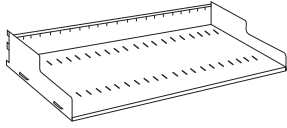

| Parent #                         | W   | H  | D   | Wt. | List Price |
|----------------------------------|-----|----|-----|-----|------------|
| <b>GSA Slotted Shelves (SLF)</b> |     |    |     |     |            |
| ARC2412SLF                       | 24" | 6" | 12" | 8   | 113.00     |
| ARC3015SLF                       | 30" | 6" | 15" | 12  | 138.00     |

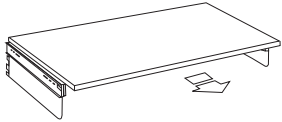

|  |     |   |     |    |        |
|--|-----|---|-----|----|--------|
| <b>GSA Pull Out Reference Shelves (RS)</b> |     |   |     |    |        |
| ARC2412RS                                  | 24" | — | 12" | 20 | 473.00 |
| ARC3015RS                                  | 30" | — | 15" | 23 | 496.00 |

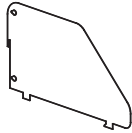

|  |   |    |     |     |       |
|--|---|----|-----|-----|-------|
| <b>GSA Adjustable File Dividers(DV) – Standard Pack of 6</b> |   |    |     |     |       |
| F12DV6   | — | 6" | 12" | 6   | 68.00 |
| F15DV6   | — | 6" | 15" | 7.5 | 78.00 |

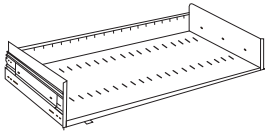

|                                    |     |    |     |    |        |
|------------------------------------|-----|----|-----|----|--------|
| <b>GSA Rollout Shelves (ROSLF)</b> |     |    |     |    |        |
| ARC2412ROSLF                       | 24" | 6" | 12" | 22 | 473.00 |
| ARC3015ROSLF                       | 30" | 6" | 15" | 25 | 539.00 |

**Note:** When ordering rollout accessories, **Upright Rollout Supports** must be ordered for each side of the ARC™ Rotary File with installed rollout accessories. (See page 104)

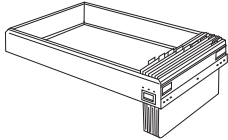

|  |     |   |     |      |        |
|--|-----|---|-----|------|--------|
| <b>GSA Rollout Hanging Frames (ROHF)</b> |     |   |     |      |        |
| ARC2412ROHF                              | 24" | — | 12" | 12.5 | 473.00 |
| ARC3015ROHF                              | 30" | — | 15" | 13.5 | 494.00 |

**Note:** When ordering rollout accessories, **Upright Rollout Supports** must be ordered for each side of the ARC™ Rotary File with installed rollout accessories. (See page 104)

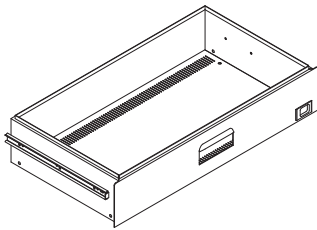

| <b>GSA Rollout Drawers (ROD)</b> |  |      |     |     |            |
|----------------------------------|--|------|-----|-----|------------|
| Parent #                         |  | H    | D   | Wt. | List Price |
| ARC2412ROD105                    |  | 10½" | 12" | 32  | 563.00     |
| ARC3015ROD105                    |  | 10½" | 15" | 36  | 601.00     |
| ARC2412ROD120                    |  | 12"  | 12" | 37  | 612.00     |
| ARC3015ROD120                    |  | 12"  | 15" | 41  | 656.00     |

**Note:** When ordering rollout accessories, **Upright Rollout Supports** must be ordered for each side of the ARC™ Rotary File with installed rollout accessories. (See page 151)

Contact your local Safco Sales Rep Group to discuss space planning specific application, obtain prior approval and quote.

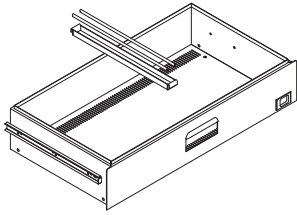

**GSA Converter Bar (CB)**

Use with rollout drawers or hanging frame kits  
To file front-to-back, use the following converter bars:

- Sold individually, not in pairs

| Parent # | D   | Wt. | List Price |
|----------|-----|-----|------------|
| ARC12CB  | 12" | 1   | 103.00     |
| ARC15CB  | 15" | 1   | 110.00     |

**GSA Upright Rollout Supports (sold in pairs)**

Required on each side of ARC™ Rotary File with Rollout Components

| Parent # | Description     | List Price |
|----------|-----------------|------------|
| URS6     | 6-Tier Supports | 135.00     |
| URS7     | 7-Tier Supports | 135.00     |
| URS8     | 8-Tier Supports | 135.00     |

Order 2 pair if filling both sides of the cabinet.

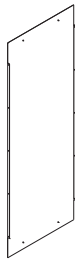

**GSA Center Panels (CP)**

Used as security or privacy panel between front and back sections of cabinet.

| Parent #  | W   | H      | Wt. | List Price |
|-----------|-----|--------|-----|------------|
| ARC2472CP | 23" | 6-tier | 19  | 274.00     |
| ARC3072CP | 29" | 6-tier | 24  | 291.00     |
| ARC2482CP | 23" | 7-tier | 22  | 296.00     |
| ARC3082CP | 29" | 7-tier | 28  | 318.00     |
| ARC2493CP | 23" | 8-tier | 25  | 343.00     |
| ARC3093CP | 29" | 8-tier | 32  | 370.00     |

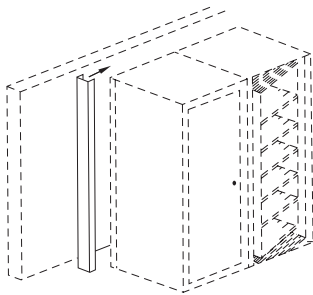

**GSA Wall Closure Strips (WCS)**

Closes space between ARC™ unit and wall. Letter: 5 1/4", Legal: 6 1/2".

| Parent #   | Size | H      | Wt. | List Price |
|------------|------|--------|-----|------------|
| ARC2472WCS | LTR  | 6-tier | 18  | 154.00     |
| ARC3072WCS | LGL  | 6-tier | 20  | 154.00     |
| ARC2482WCS | LTR  | 7-tier | 23  | 185.00     |
| ARC3082WCS | LGL  | 7-tier | 28  | 181.00     |
| ARC2493WCS | LTR  | 8-tier | 27  | 214.00     |
| ARC3093WCS | LGL  | 8-tier | 30  | 214.00     |

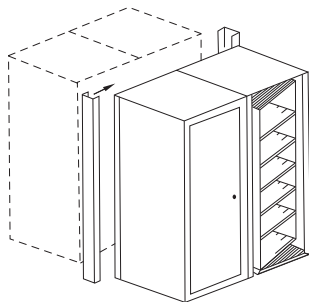

**GSA Back-to-Back Closure Strips (BTB)**

Used to enclose the space between two ARC™ units when placed back-to-back.  
Letter: 10 1/2", Legal: 13"

| Parent #   | Size | H      | Wt. | List Price |
|------------|------|--------|-----|------------|
| ARC2472BTB | LTR  | 6-tier | 32  | 185.00     |
| ARC3072BTB | LGL  | 6-tier | 32  | 185.00     |
| ARC2482BTB | LTR  | 7-tier | 40  | 214.00     |
| ARC3082BTB | LGL  | 7-tier | 40  | 210.00     |
| ARC2493BTB | LTR  | 8-tier | 48  | 238.00     |
| ARC3093BTB | LGL  | 8-tier | 48  | 243.00     |

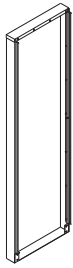

**GSA** End Panel Assemblies (EP)

| Parent #  | Size | H      | Wt. | List Price |
|-----------|------|--------|-----|------------|
| ARC2472EP | LTR  | 6-tier | 29  | 746.00     |
| ARC3072EP | LGL  | 6-tier | 33  | 854.00     |
| ARC2482EP | LTR  | 7-tier | 32  | 854.00     |
| ARC3082EP | LGL  | 7-tier | 37  | 866.00     |
| ARC2493EP | LTR  | 8-tier | 36  | 932.00     |
| ARC3093EP | LGL  | 8-tier | 42  | 1,014.00   |

Contact your local Safco Sales Rep Group to discuss space planning specific application, obtain prior approval and quote.

**FLIP-N-FILE™ CABINET**

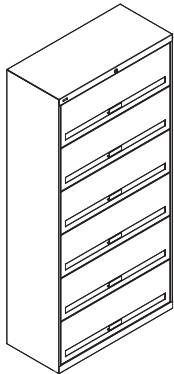

- The Flip-n-File™ Cabinet comes fully assembled and ready to use.
- Shelves are fixed with a 9¾" H clearance between shelves
- 120 lb. load capacity per shelf
- Inside width dimension of each shelf is 34"
- Accommodates letter or legal filing
- All units come with 4 file dividers per shelf
- Additional dividers are available
- Lock is located at the top of the cabinet
- Standard Finishes: Pebble Gray, Sand Beige and Black Only
- Inside depth is 15½"

| Parent # | Description         | W   | Size H | D   | Wt. | List Price | List Price Add "K" Suffix Keyed Alike |
|----------|---------------------|-----|--------|-----|-----|------------|---------------------------------------|
| FFD5     | 5 Tier with Doors   | 36" | 63½"   | 17" | 160 | 3,795.00   | 3,822.00                              |
| FFD6     | 6 Tier with Doors   | 36" | 75¼"   | 17" | 186 | 4,205.00   | 4,148.00                              |
| FFD7     | 7 Tier with Doors   | 36" | 87"    | 17" | 212 | 4,848.00   | 4,953.00                              |
| FFD      | Additional Dividers |     |        |     |     | 3.00       | -                                     |
| FFDMK    | Master Key          |     |        |     | 1   | 35.00      | -                                     |

Note: For keyed alike cabinets, add a "K" to the end of the model number. See final column for keyed alike pricing (with door only).

**FLIP-N-FILE™ CABINETS ON KWIK-TRACK**

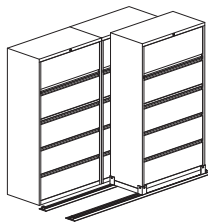

To increase filing density, Flip-n-File™ shelving can also mount to Kwik-Track systems creating either a bi-file or tri-file sliding shelving system. In either configuration, the rear row of cabinets are stationary with cabinets in front mounted on a sliding carriage on a track mounted to floor.

- Heavy-duty aluminum track construction supports 3,500 lbs. per carriage
- Anti-tip built into base for stability and easy installation
- Systems are complete with cabinets and track. Four dividers per shelf are included
- Track system has a Brushed Aluminum finish. Floor mounting hardware included
- Track adds 2¾" to overall height of system
- All configurations below have doors

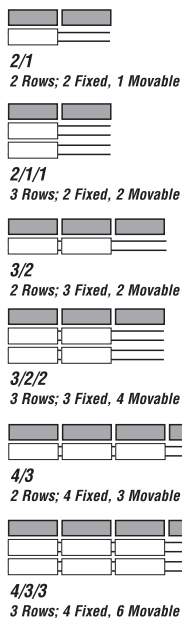

| Parent #                    | Description          | Dimensions           | Wt.   | List Price | List Price Add "K" Suffix Keyed Alike |
|-----------------------------|----------------------|----------------------|-------|------------|---------------------------------------|
| <b>5-Tier Cabinet 36" D</b> |                      |                      |       |            |                                       |
| FF521                       | 2/1 5-Tier Cabinet   | 78"W x 36"D x 66¼"H  | 505   | 13,111.00  | -                                     |
| FF532                       | 3/2 5-Tier Cabinet   | 116"W x 36"D x 66¼"H | 840   | -          | 22,727.00                             |
| FF543                       | 4/3 5-Tier Cabinet   | 156"W x 36"D x 66¼"H | 1,165 | 31,026.00  | -                                     |
| <b>5-Tier Cabinet 56" D</b> |                      |                      |       |            |                                       |
| FF5322                      | 3/2/2 5-Tier Cabinet | 116"W x 56"D x 66¼"H | 1,150 | 33,711.00  | -                                     |
| <b>6-Tier Cabinet 36" D</b> |                      |                      |       |            |                                       |
| FF621                       | 2/1 6-Tier Cabinet   | 78"W x 36"D x 78"H   | 583   | 14,692.00  | -                                     |
| FF632                       | 3/2 6-Tier Cabinet   | 116"W x 36"D x 78"H  | 970   | 24,581.00  | 24,813.00                             |
| <b>6-Tier Cabinet 56" D</b> |                      |                      |       |            |                                       |
| FF6322                      | 3/2/2 6-Tier Cabinet | 116"W x 56"D x 78"H  | 1,332 | 36,384.00  | 36,824.00                             |
| <b>7-Tier Cabinet 36" D</b> |                      |                      |       |            |                                       |
| FF721                       | 2/1 7-Tier Cabinet   | 78"W x 36"D x 89¾"H  | 661   | -          | 16,854.00                             |
| FF732                       | 3/2 7-Tier Cabinet   | 116"W x 36"D x 89¾"H | 1,100 | 27,105.00  | -                                     |
| FF743                       | 4/3 7-Tier Cabinet   | 156"W x 36"D x 89¾"H | 1,529 | 37,917.00  | 38,602.00                             |
| <b>7-Tier Cabinet 56" D</b> |                      |                      |       |            |                                       |
| FF7211                      | 2/1/1 7-Tier Cabinet | 78"W x 56"D x 89¾"H  | 868   | 23,540.00  | -                                     |
| FF7322                      | 3/2/2 7-Tier Cabinet | 116"W x 56"D x 89¾"H | 1,514 | 40,599.00  | -                                     |

Note: For keyed alike cabinets, add a "K" to the end of the model number. See final column for keyed alike pricing.