



Get Your Bespoke Office Design Today

We'll Get You The Right Office Furniture

Call Now (856)-368-9085

Call Now To Order (856) 368-9085

50% OFF Sale On Now

Nationwide Delivery and Installation

Office Doctor Discount Office Furniture

[www.OfficeDr.com](http://www.OfficeDr.com) 856-368-9085

Safco Sale On Now

Take 50% Off the List Prices in this PDF

**Call 856-368-9085 Now**

Free Layout & Design Service

Mailflow Mailroom Series



The perfect solution for smaller organizations needing economical and functional mail center furniture.

- Rugged steel frame construction with 1" thick thermally-fused low-pressure laminate work surfaces
- 500 lb. weight capacity
- Ready to assemble

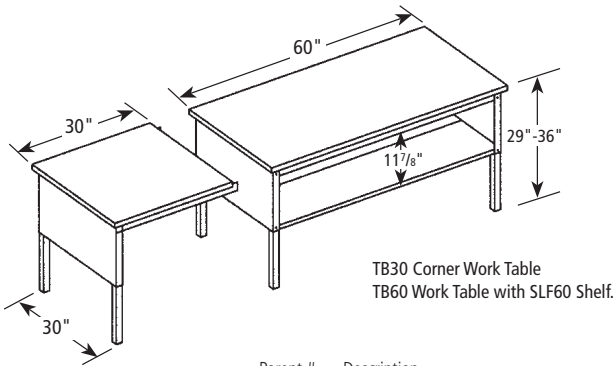

TB30 Corner Work Table  
TB60 Work Table with SLF60 Shelf.

**Work Table**

- Choice of either a 48"W or a 60"W rectangular table with attaching 30"W corner table
- Corner table has two legs and must be installed adjacent to work table
- Legs are 1/2" square, 16-gauge brushed chrome tubular steel
- Tables adjust from 29" - 36"H on 1" increments
- Standard Finishes: Pebble Gray paint with Birch TFL laminate work surface
- Work surfaces have 3mm PVC edge
- 48"W and 60"W table has optional Shelf for under surface storage
- SLF48 and SLF60 each have 75 lb. capacity

| Parent # | Description | Model # | List Price Ea. | List Carton Price | Quantity Per Carton | Actual Weight | S-Parcel Billable Weight | Carton Cube | Freight Class |
|----------|-------------|---------|----------------|-------------------|---------------------|---------------|--------------------------|-------------|---------------|
|----------|-------------|---------|----------------|-------------------|---------------------|---------------|--------------------------|-------------|---------------|

**GSA Work Tables**

|              |  |       |          |          |   |     |   |   |   |
|--------------|--|-------|----------|----------|---|-----|---|---|---|
| <b>TB48</b>  | 48" W Work Table<br>48" W x 30" D x 29-36" H           | TB48  | 1,348.00 | 1,348.00 | 1 | 90  | - | - | - |
| <b>SLF48</b> | Shelf for 48" W Work Table<br>44" W x 25 1/2" D x 1" H | SLF48 | 316.00   | 316.00   | 1 | 20  | - | - | - |
| <b>TB60</b>  | 60" W Work Table<br>60" W x 30" D x 29-36" H           | TB60  | 1,785.00 | 1,785.00 | 1 | 112 | - | - | - |
| <b>SLF60</b> | Shelf for 60" W Work Table<br>56" W x 25 1/2" D x 1" H | SLF60 | 340.00   | 340.00   | 1 | 25  | - | - | - |
| <b>TB30</b>  | 30" W Corner Work Table<br>30" W x 30" D x 29-36" H    | TB30  | 1,282.00 | 1,282.00 | 1 | 53  | - | - | - |
| <b>1219</b>  | Pencil Tray (Black Only)<br>21" W x 16" D x 1 3/4" H   | 1219  | 231.00   | 231.00   | 1 | -   | - | - | - |

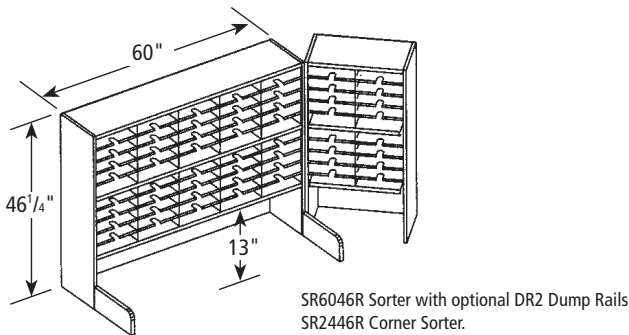

SR6046R Sorter with optional DR2 Dump Rails  
SR2446R Corner Sorter.

**Sorters**

- Standard pocket dimension: 11 5/8"W x 2 5/8"H x 1 3/4"D. Shelves are fixed
- Pockets sized to accommodate commonly used 10 x 13" flat envelopes
- 48"W and 60"W sorters available in multiple heights, with or without elevated riser
- 24"W sorter available in a two-tier with riser configuration only
- Optional side dump rails and label holders
- Durable steel construction, ready to assemble
- Pebble Gray only

| Parent # | Description | Model # | List Price Ea. | List Carton Price | Quantity Per Carton | Actual Weight | S-Parcel Billable Weight | Carton Cube | Freight Class |
|----------|-------------|---------|----------------|-------------------|---------------------|---------------|--------------------------|-------------|---------------|
|----------|-------------|---------|----------------|-------------------|---------------------|---------------|--------------------------|-------------|---------------|

**Sorters**

|                |   |         |          |          |    |       |   |   |   |
|----------------|---|---------|----------|----------|----|-------|---|---|---|
| <b>SR4833R</b> | 1-Tier Riser, 48" W x 13 1/4" D x 33 1/4" H - 20 Pockets    | SR4833R | 1,554.00 | 1,554.00 | 1  | 91    | - | - | - |
| <b>SR4833</b>  | 2-Tier No Riser, 48" W x 13 1/4" D x 33 1/4" H - 40 Pockets | SR4833  | 1,950.00 | 1,912.00 | 1  | 133   | - | - | - |
| <b>SR4846R</b> | 2-Tier Riser, 48" W x 13 1/4" D x 46 1/4" H - 40 Pockets    | SR4846R | 2,366.00 | 2,366.00 | 1  | 146   | - | - | - |
| <b>SR6033R</b> | 1-Tier Riser, 60" W x 13 1/4" D x 33 1/4" H - 25 Pockets    | SR6033R | 1,581.00 | 1,581.00 | 1  | 113   | - | - | - |
| <b>SR6033</b>  | 2-Tier No Riser, 60" W x 13 1/4" D x 33 1/4" H - 50 Pockets | SR6033  | 2,051.00 | 2,051.00 | 1  | 166   | - | - | - |
| <b>SR6046R</b> | 2-Tier Riser, 60" W x 13 1/4" D x 46 1/4" H - 50 Pockets    | SR6046R | 2,559.00 | 2,559.00 | 1  | 182   | - | - | - |
| <b>SR2446R</b> | Corner Sorter, 24" W x 13 1/4" D x 46 1/4" H - 20 Pockets   | SR2446R | 1,548.00 | 1,548.00 | 1  | 85    | - | - | - |
| <b>90145</b>   | Label Holder (Set of 20) - Adhesive                         | 90145   | 2.45     | -        | 20 | 1 oz. | - | - | - |
| <b>911785</b>  | Label Holder (Set of 20) - Magnetic                         | 911785  | 3.65     | -        | 20 | 3 oz. | - | - | - |
| <b>922VEL</b>  | Label Holder (Set of 20) - Velcro®                          | 922VEL  | 80.00    | -        | 20 | 3 oz. | - | - | - |

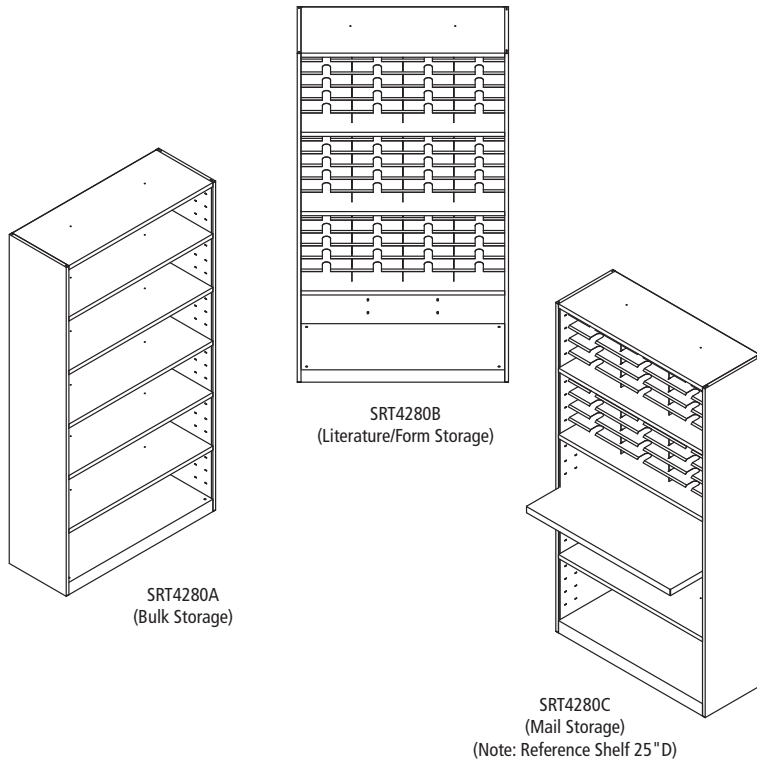

**Mailflow-To-Go™ Cabinets**

These reconfigurable Mailflow-to-Go™ cabinets are a perfect addition to any mail or storage room. Their clever design uses one standard cabinet with any of three internal configurations creating a mail sort station, literature organizer or a standard shelving unit for bulk storage.

- Cabinet measures 42"W x 80"H x 16"D
- Weight capacity 50 lbs. per shelf
- Three unique configurations (Mail, Literature or Bulk Storage)
- Easy to assemble, no hardware required
- Available in Pebble Gray only

| Parent #            | Description   | Model #  | List Price Ea. | List Carton Price | Quantity Per Carton | Actual Weight | S-Parcel Billable Weight | Carton Cube | Freight Class |
|---------------------|---|----------|----------------|-------------------|---------------------|---------------|--------------------------|-------------|---------------|
| <b>GSA Cabinets</b> |   |          |                |                   |                     |               |                          |             |               |
| SRT4280A            | Bulk Storage Cabinet, 5 Adjustable Shelves<br>42"W x 16"D x 80"H  | SRT4280A | 2,510.00       | 2,510.00          | 1                   | 154           | -                        | -           | -             |
| SRT4280B            | Storage Cabinet, Literature/Forms, 72 Pockets<br>42"W x 16"D x 80"H,<br>Pocket Size: 10 1/8"W x 12 3/4"D x 23/4"H | SRT4280B | 3,968.00       | 3,968.00          | 1                   | 234           | -                        | -           | -             |
| SRT4280C            | Mail Storage Cabinet, 30 Pockets<br>42"W x 16"D x 80"H,<br>Pocket Size: 13 1/8"W x 12 3/4"D x 21/8"H              | SRT4280C | 3,592.00       | 3,592.00          | 1                   | 202           | -                        | -           | -             |

**Closed-Back Sorter**

- All sorters are 15" deep
- 50 lb. weight capacity per shelf
- Shelves adjustable on .5" increments
- Available in Safco® Corporate Colors see page 8 or go to [Safcoproducts.com](http://Safcoproducts.com) for more information
- For assistance with custom Mailflow Systems configuration contact Safco Sales Rep Group

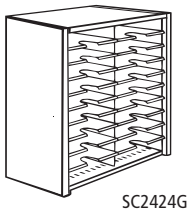
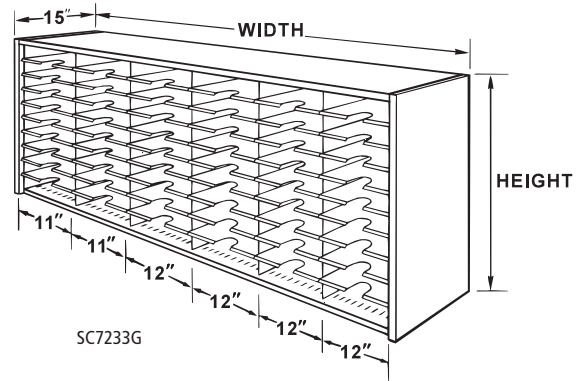

| Parent # | Description  | Model # | List Price Ea. | List Carton Price | Quantity Per Carton | Actual Weight | S-Parcel Billable Weight | Carton Cube | Freight Class |
|----------|--|---------|----------------|-------------------|---------------------|---------------|--------------------------|-------------|---------------|
| SC2424   | Mailflow System® Closed-Back Sorter<br>Shelf Capacity: 14<br>2 columns of 11"W Shelves<br>Size: 24"W x 15"D x 24"H<br>Size (Inside): 22"W x 15"D x 21"H<br>14 Sorting Pockets 15"D without Plexi Doors - G | SC2424G | 2,215.00       | 2,215.00          | 1                   | 80            | -                        | -           | -             |
| SC2433   | Mailflow System® Closed-Back Sorter<br>Shelf Capacity: 20<br>2 columns of 11"W Shelves<br>Size: 24"W x 15"D x 33"H<br>Size (Inside): 22"W x 15"D x 30"H<br>20 Sorting Pockets 15"D without Plexi Doors - G | SC2433G | 2,748.00       | 2,748.00          | 1                   | 106           | -                        | -           | -             |
| SC2441   | Mailflow System® Closed-Back Sorter<br>Shelf Capacity: 24<br>2 columns of 11"W Shelves<br>Size: 24"W x 15"D x 41"H<br>Size (Inside): 22"W x 15"D x 38"H<br>24 Sorting Pockets 15"D without Plexi Doors - G | SC2441G | 3,086.00       | 3,086.00          | 1                   | 127           | -                        | -           | -             |
| SC2448   | Mailflow System® Closed-Back Sorter<br>Shelf Capacity: 30<br>2 columns of 11"W Shelves<br>Size: 24"W x 15"D x 48"H<br>Size (Inside): 22"W x 15"D x 45"H<br>30 Sorting Pockets 15"D without Plexi Doors - G | SC2448G | 3,382.00       | 3,382.00          | 1                   | 152           | -                        | -           | -             |

**Note:** All preconfigured models are standard with two columns of 11" wide shelves and the remaining columns with 12" wide shelves. You may receive extra shelves with preconfigured sorters.

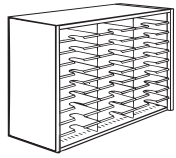

SC3624G

| Parent #                    | Description  | Model # | List Price Ea. | List Carton Price | Quantity Per Carton | Actual Weight | S-Parcel Billable Weight | Carton Cube | Freight Class |
|-----------------------------|--|---------|----------------|-------------------|---------------------|---------------|--------------------------|-------------|---------------|
| <b>SC3624</b><br><b>GSA</b> | Mailflow System® Closed-Back Sorter<br>Shelf Capacity: 21<br>2 columns of 11"W & 1 column 12"W Shelves<br>Size: 36"W x 15"D x 24"H<br>Size (Inside): 34"W x 15"D x 21"H<br>21 Sorting Pockets 15"D without Plexi Doors - G | SC3624G | 2,322.00       | 2,322.00          | 1                   | 115           | -                        | -           | -             |
| <b>SC3633</b><br><b>GSA</b> | Mailflow System® Closed-Back Sorter<br>Shelf Capacity: 30<br>2 columns of 11"W & 1 column 12"W Shelves<br>Size: 36"W x 15"D x 33"H<br>Size (Inside): 34"W x 15"D x 30"H<br>30 Sorting Pockets 15"D without Plexi Doors - G | SC3633G | 3,055.00       | 3,055.00          | 1                   | 152           | -                        | -           | -             |
| <b>SC3641</b><br><b>GSA</b> | Mailflow System® Closed-Back Sorter<br>Shelf Capacity: 36<br>2 columns of 11"W & 1 column 12"W Shelves<br>Size: 36"W x 15"D x 41"H<br>Size (Inside): 34"W x 15"D x 38"H<br>36 Sorting Pockets 15"D without Plexi Doors - G | SC3641G | 3,231.00       | 3,231.00          | 1                   | 181           | -                        | -           | -             |
| <b>SC3648</b><br><b>GSA</b> | Mailflow System® Closed-Back Sorter<br>Shelf Capacity: 45<br>2 columns of 11"W & 1 column 12"W Shelves<br>Size: 36"W x 15"D x 48"H<br>Size (Inside): 34"W x 15"D x 45"H<br>45 Sorting Pockets 15"D without Plexi Doors - G | SC3648G | 3,735.00       | 3,735.00          | 1                   | 218           | -                        | -           | -             |

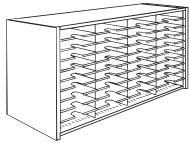

SC4824G

|                             |  |         |          |          |   |     |   |   |   |
|-----------------------------|--|---------|----------|----------|---|-----|---|---|---|
| <b>SC4824</b><br><b>GSA</b> | Mailflow System® Closed-Back Sorter<br>Shelf Capacity: 28<br>2 columns of 11"W & 2 column 12"W Shelves<br>Size: 48"W x 15"D x 24"H<br>Size (Inside): 46"W x 15"D x 21"H<br>28 Sorting Pockets 15"D without Plexi Doors - G | SC4824G | 3,348.00 | 3,348.00 | 1 | 150 | - | - | - |
| <b>SC4833</b><br><b>GSA</b> | Mailflow System® Closed-Back Sorter<br>Shelf Capacity: 40<br>2 columns of 11"W & 2 column 12"W Shelves<br>Size: 48"W x 15"D x 33"H<br>Size (Inside): 46"W x 15"D x 30"H<br>40 Sorting Pockets 15"D without Plexi Doors - G | SC4833G | 4,071.00 | 4,071.00 | 1 | 198 | - | - | - |
| <b>SC4841</b><br><b>GSA</b> | Mailflow System® Closed-Back Sorter<br>Shelf Capacity: 48<br>2 columns of 11"W & 2 column 12"W Shelves<br>Size: 48"W x 15"D x 41"H<br>Size (Inside): 46"W x 15"D x 38"H<br>48 Sorting Pockets 15"D without Plexi Doors - G | SC4841G | 4,583.00 | 4,583.00 | 1 | 235 | - | - | - |
| <b>SC4848</b><br><b>GSA</b> | Mailflow System® Closed-Back Sorter<br>Shelf Capacity: 60<br>2 columns of 11"W & 2 column 12"W Shelves<br>Size: 48"W x 15"D x 48"H<br>Size (Inside): 46"W x 15"D x 45"H<br>60 Sorting Pockets 15"D without Plexi Doors - G | SC4848G | 5,624.00 | 5,624.00 | 1 | 283 | - | - | - |

**Note:** All preconfigured models are standard with two columns of 11" wide shelves and the remaining columns with 12" wide shelves. You may receive extra shelves with preconfigured sorters.



SC6024G

|               |  |         |          |          |   |     |   |   |   |
|---------------|--|---------|----------|----------|---|-----|---|---|---|
| <b>SC6024</b> | Mailflow System® Closed-Back Sorter<br>Shelf Capacity: 35<br>2 columns of 11"W & 3 column 12"W Shelves<br>Size: 60"W x 15"D x 24"H<br>Size (Inside): 58"W x 15"D x 21"H<br>35 Sorting Pockets 15"D without Plexi Doors - G | SC6024G | 3,827.00 | 3,827.00 | 1 | 185 | - | - | - |
|---------------|--|---------|----------|----------|---|-----|---|---|---|

|               |  |         |          |          |   |     |   |   |   |
|---------------|--|---------|----------|----------|---|-----|---|---|---|
| <b>SC6033</b> | Mailflow System® Closed-Back Sorter<br>Shelf Capacity: 50<br>2 columns of 11"W & 3 column 12"W Shelves<br>Size: 60"W x 15"D x 33"H<br>Size (Inside): 58"W x 15"D x 30"H<br>50 Sorting Pockets 15"D without Plexi Doors - G | SC6033G | 4,820.00 | 4,820.00 | 1 | 230 | - | - | - |
|---------------|--|---------|----------|----------|---|-----|---|---|---|

|               |  |         |          |          |   |     |   |   |   |
|---------------|--|---------|----------|----------|---|-----|---|---|---|
| <b>SC6041</b> | Mailflow System® Closed-Back Sorter<br>Shelf Capacity: 60<br>2 columns of 11"W & 3 column 12"W Shelves<br>Size: 60"W x 15"D x 41"H<br>Size (Inside): 58"W x 15"D x 38"H<br>60 Sorting Pockets 15"D without Plexi Doors - G | SC6041G | 5,542.00 | 5,542.00 | 1 | 261 | - | - | - |
|---------------|--|---------|----------|----------|---|-----|---|---|---|

|               |  |         |          |          |   |     |   |   |   |
|---------------|--|---------|----------|----------|---|-----|---|---|---|
| <b>SC6048</b> | Mailflow System® Closed-Back Sorter<br>Shelf Capacity: 75<br>2 columns of 11"W & 3 column 12"W Shelves<br>Size: 60"W x 15"D x 48"H<br>Size (Inside): 58"W x 15"D x 45"H<br>75 Sorting Pockets 15"D without Plexi Doors - G | SC6048G | 6,514.00 | 6,514.00 | 1 | 306 | - | - | - |
|---------------|--|---------|----------|----------|---|-----|---|---|---|

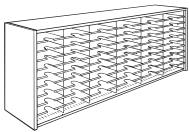

SC7224G

|               |  |         |          |          |   |     |   |   |   |
|---------------|--|---------|----------|----------|---|-----|---|---|---|
| <b>SC7224</b> | Mailflow System® Closed-Back Sorter<br>Shelf Capacity: 42<br>2 columns of 11"W & 4 column 12"W Shelves<br>Size: 72"W x 15"D x 24"H<br>Size (Inside): 70"W x 15"D x 21"H<br>42 Sorting Pockets 15"D without Plexi Doors - G | SC7224G | 4,540.00 | 4,540.00 | 1 | 214 | - | - | - |
|---------------|--|---------|----------|----------|---|-----|---|---|---|

|               |  |         |          |          |   |     |   |   |   |
|---------------|--|---------|----------|----------|---|-----|---|---|---|
| <b>SC7233</b> | Mailflow System® Closed-Back Sorter<br>Shelf Capacity: 60<br>2 columns of 11"W & 4 column 12"W Shelves<br>Size: 72"W x 15"D x 33"H<br>Size (Inside): 70"W x 15"D x 30"H<br>60 Sorting Pockets 15"D without Plexi Doors - G | SC7233G | 5,697.00 | 5,697.00 | 1 | 269 | - | - | - |
|---------------|--|---------|----------|----------|---|-----|---|---|---|

|               |  |         |          |          |   |     |   |   |   |
|---------------|--|---------|----------|----------|---|-----|---|---|---|
| <b>SC7241</b> | Mailflow System® Closed-Back Sorter<br>Shelf Capacity: 72<br>2 columns of 11"W & 4 column 12"W Shelves<br>Size: 72"W x 15"D x 41"H<br>Size (Inside): 70"W x 15"D x 38"H<br>72 Sorting Pockets 15"D without Plexi Doors - G | SC7241G | 6,478.00 | 6,478.00 | 1 | 309 | - | - | - |
|---------------|--|---------|----------|----------|---|-----|---|---|---|

|               |  |         |          |          |   |     |   |   |   |
|---------------|--|---------|----------|----------|---|-----|---|---|---|
| <b>SC7248</b> | Mailflow System® Closed-Back Sorter<br>Shelf Capacity: 90<br>2 columns of 11"W & 4 column 12"W Shelves<br>Size: 72"W x 15"D x 48"H<br>Size (Inside): 70"W x 15"D x 45"H<br>90 Sorting Pockets 15"D without Plexi Doors - G | SC7248G | 7,652.00 | 7,652.00 | 1 | 364 | - | - | - |
|---------------|--|---------|----------|----------|---|-----|---|---|---|

**Note:** All preconfigured models are standard with two columns of 11" wide shelves and the remaining columns with 12" wide shelves. You may receive extra shelves with preconfigured sorters.

**Elevated Closed-Back Sorter**

- All sorters are 15" deep
- Sorting shelves are 12", 14" or 15" deep. Adjust on 1/2"H increments
- Preconfigured models available, or build-your-own and adding components on page page 152-167.
- Pricing below is for sorters without locking doors
- Available in Safco® Corporate Colors see page 7 or go to [Safcoproducts.com](http://Safcoproducts.com) for more information

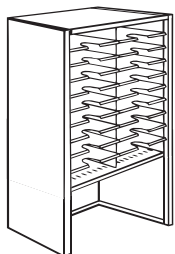
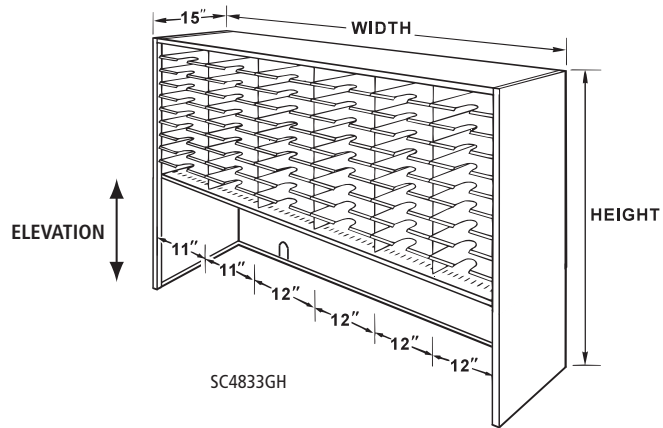

SC2433GL

| Parent #      | Description  | Model #  | List Price Ea. | List Carton Price | Quantity Per Carton | Actual Weight | S-Parcel Billable Weight | Carton Cube | Freight Class |
|---------------|--|----------|----------------|-------------------|---------------------|---------------|--------------------------|-------------|---------------|
| <b>SC2433</b> | Mailflow System® Elevated 9" H Closed-Back Sorter<br>Shelf Capacity: 14<br>2 columns of 11" W Shelves<br>Size: 24" W x 15" D x 33" H<br>Size (Inside): 22" W x 15" D x 21" H<br>14 Sorting Pockets 15" D without Plexi Doors - GL  | SC2433GL | 2,440.00       | 2,440.00          | 1                   | 95            | -                        | -           | -             |
| <b>SC2441</b> | Mailflow System® Elevated 8" H Closed-Back Sorter<br>Shelf Capacity: 20<br>2 columns of 11" W Shelves<br>Size: 24" W x 15" D x 41" H<br>Size (Inside): 22" W x 15" D x 30" H<br>20 Sorting Pockets 15" D without Plexi Doors - GL  | SC2441GL | 2,961.00       | 2,961.00          | 1                   | 111           | -                        | -           | -             |
|               | Mailflow System® Elevated 17" H Closed-Back Sorter<br>Shelf Capacity: 14<br>2 columns of 11" W Shelves<br>Size: 24" W x 15" D x 41" H<br>Size (Inside): 22" W x 15" D x 21" H<br>14 Sorting Pockets 15" D without Plexi Doors - GH | SC2441GH | 2,749.00       | 2,749.00          | 1                   | 105           | -                        | -           | -             |
| <b>SC2448</b> | Mailflow System® Elevated 7" H Closed-Back Sorter<br>Shelf Capacity: 24<br>2 columns of 11" W Shelves<br>Size: 24" W x 15" D x 48" H<br>Size (Inside): 22" W x 15" D x 38" H<br>24 Sorting Pockets 15" D without Plexi Doors - GL  | SC2448GL | 3,283.00       | 3,283.00          | 1                   | 132           | -                        | -           | -             |
|               | Mailflow System® Elevated 15" H Closed-Back Sorter<br>Shelf Capacity: 20<br>2 columns of 11" W Shelves<br>Size: 24" W x 15" D x 48" H<br>Size (Inside): 22" W x 15" D x 30" H<br>20 Sorting Pockets 15" D without Plexi Doors - GH | SC2448GH | 3,244.00       | 3,244.00          | 1                   | 132           | -                        | -           | -             |

**Note:** All preconfigured models are standard with two columns of 11" wide shelves and the remaining columns with 12" wide shelves. You may receive extra shelves with sorters.

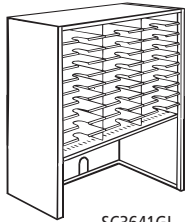



SC3641GL

|  |     |          |          |          |   |     |   |   |   |
|--|-----|----------|----------|----------|---|-----|---|---|---|
| <b>SC3633</b> Mailflow System® Elevated 9"H Closed-Back Sorter<br>Shelf Capacity: 21<br>2 columns of 11"W & 1 column 12"W Shelves<br>Size: 36"W x 15"D x 33"H<br>Size (Inside): 34"W x 15"D x 21"H<br>21 Sorting Pockets 15"D without Plexi Doors - GL |     |          |          |          |   |     |   |   |   |
|  | GSA | SC3633GL | 2,733.00 | 2,733.00 | 1 | 128 | - | - | - |
| <b>SC3641</b> Mailflow System® Elevated 8"H Closed-Back Sorter<br>Shelf Capacity: 30<br>2 columns of 11"W & 1 column 12"W Shelves<br>Size: 36"W x 15"D x 41"H<br>Size (Inside): 34"W x 15"D x 30"H<br>30 Sorting Pockets 15"D without Plexi Doors - GL |     |          |          |          |   |     |   |   |   |
|  | GSA | SC3641GL | 3,526.00 | 3,526.00 | 1 | 168 | - | - | - |
| Mailflow System® Elevated 17"H Closed-Back Sorter<br>Shelf Capacity: 21<br>2 columns of 11"W & 1 column 12"W Shelves<br>Size: 36"W x 15"D x 41"H<br>Size (Inside): 34"W x 15"D x 21"H<br>21 Sorting Pockets 15"D without Plexi Doors - GH              |     |          |          |          |   |     |   |   |   |
|  |     | SC3641GH | 2,937.00 | 2,937.00 | 1 | 149 | - | - | - |
| <b>SC3648</b> Mailflow System® Elevated 7"H Closed-Back Sorter<br>Shelf Capacity: 36<br>2 columns of 11"W & 1 column 12"W Shelves<br>Size: 36"W x 15"D x 48"H<br>Size (Inside): 34"W x 15"D x 38"H<br>36 Sorting Pockets 15"D without Plexi Doors - GL |     |          |          |          |   |     |   |   |   |
|  | GSA | SC3648GL | 3,967.00 | 3,967.00 | 1 | 198 | - | - | - |
| Mailflow System® Elevated 15"H Closed-Back Sorter<br>Shelf Capacity: 20<br>2 columns of 11"W & 1 column 12"W Shelves<br>Size: 36"W x 15"D x 48"H<br>Size (Inside): 34"W x 15"D x 30"H<br>20 Sorting Pockets 15"D without Plexi Doors - GH              |     |          |          |          |   |     |   |   |   |
|  |     | SC3648GH | 3,830.00 | 3,830.00 | 1 | 187 | - | - | - |
| <b>SC4833</b> Mailflow System® Elevated 9"H Closed-Back Sorter<br>Shelf Capacity: 28<br>2 columns of 11"W & 2 column 12"W Shelves<br>Size: 48"W x 15"D x 33"H<br>Size (Inside): 46"W x 15"D x 21"H<br>28 Sorting Pockets 15"D without Plexi Doors - GL |     |          |          |          |   |     |   |   |   |
|  | GSA | SC4833GL | 3,454.00 | 3,454.00 | 1 | 160 | - | - | - |
| <b>SC4841</b> Mailflow System® Elevated 8"H Closed-Back Sorter<br>Shelf Capacity: 40<br>2 columns of 11"W & 2 column 12"W Shelves<br>Size: 48"W x 15"D x 41"H<br>Size (Inside): 46"W x 15"D x 30"H<br>40 Sorting Pockets 15"D without Plexi Doors - GL |     |          |          |          |   |     |   |   |   |
|  | GSA | SC4841GL | 4,393.00 | 4,393.00 | 1 | 224 | - | - | - |
| Mailflow System® Elevated 17"H Closed-Back Sorter<br>Shelf Capacity: 28<br>2 columns of 11"W & 2 column 12"W Shelves<br>Size: 48"W x 15"D x 41"H<br>Size (Inside): 46"W x 15"D x 21"H<br>28 Sorting Pockets 15"D without Plexi Doors - GH              |     |          |          |          |   |     |   |   |   |
|  |     | SC4841GH | 3,660.00 | 3,660.00 | 1 | 193 | - | - | - |

**Note:** All preconfigured models are standard with two columns of 11" wide shelves and the remaining columns with 12" wide shelves. You may receive extra shelves with sorters.

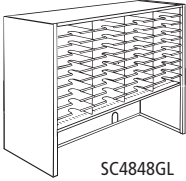

| Parent #  | Description  | Model #  | List Price Ea. | List Carton Price | Number of Cartons | Actual Weight | S-Parcel Billable Weight | Carton Cube | Freight Class |
|---|--|----------|----------------|-------------------|-------------------|---------------|--------------------------|-------------|---------------|
| <br>SC4848GL   | <b>SC4848</b> Mailflow System® Elevated 7"H Closed-Back Sorter<br>Shelf Capacity: 48<br>2 columns of 11"W & 2 column 12"W Shelves<br>Size: 48"W x 15"D x 48"H<br>Size (Inside): 46"W x 15"D x 38"H<br>48 Sorting Pockets 15"D without Plexi Doors - GL | SC4848GL | 5,360.00       | 5,360.00          | 1                 | 263           | -                        | -           | -             |
|   | Mailflow System® Elevated 15"H Closed-Back Sorter<br>Shelf Capacity: 40<br>2 columns of 11"W & 2 column 12"W Shelves<br>Size: 48"W x 15"D x 48"H<br>Size (Inside): 46"W x 15"D x 30"H<br>40 Sorting Pockets 15"D without Plexi Doors - GH              | SC4848GH | 4,705.00       | 4,705.00          | 1                 | 241           | -                        | -           | -             |
| <br>SC6033GL   | <b>SC6033</b> Mailflow System® Elevated 9"H Closed-Back Sorter<br>Shelf Capacity: 35<br>2 columns of 11"W & 3 column 12"W Shelves<br>Size: 60"W x 15"D x 33"H<br>Size (Inside): 58"W x 15"D x 21"H<br>35 Sorting Pockets 15"D without Plexi Doors - GL | SC6033GL | 4,051.00       | 4,051.00          | 1                 | 203           | -                        | -           | -             |
|   | <b>SC6041</b> Mailflow System® Elevated 8"H Closed-Back Sorter<br>Shelf Capacity: 50<br>2 columns of 11"W & 3 column 12"W Shelves<br>Size: 60"W x 15"D x 41"H<br>Size (Inside): 58"W x 15"D x 30"H<br>50 Sorting Pockets 15"D without Plexi Doors - GL | SC6041GL | 5,141.00       | 5,141.00          | 1                 | 248           | -                        | -           | -             |
|   | Mailflow System® Elevated 17"H Closed-Back Sorter<br>Shelf Capacity: 35<br>2 columns of 11"W & 3 column 12"W Shelves<br>Size: 60"W x 15"D x 41"H<br>Size (Inside): 58"W x 15"D x 21"H<br>35 Sorting Pockets 15"D without Plexi Doors - GH              | SC6041GH | 4,361.00       | 4,361.00          | 1                 | 208           | -                        | -           | -             |
| <br>SC6048GL | <b>SC6048</b> Mailflow System® Elevated 7"H Closed-Back Sorter<br>Shelf Capacity: 60<br>2 columns of 11"W & 3 column 12"W Shelves<br>Size: 60"W x 15"D x 48"H<br>Size (Inside): 58"W x 15"D x 38"H<br>60 Sorting Pockets 15"D without Plexi Doors - GL | SC6048GL | 5,972.00       | 5,972.00          | 1                 | 275           | -                        | -           | -             |
|   | Mailflow System® Elevated 15"H Closed-Back Sorter<br>Shelf Capacity: 50<br>2 columns of 11"W & 3 column 12"W Shelves<br>Size: 60"W x 15"D x 48"H<br>Size (Inside): 58"W x 15"D x 30"H<br>50 Sorting Pockets 15"D without Plexi Doors - GH              | SC6048GH | 5,457.00       | 5,457.00          | 1                 | 233           | -                        | -           | -             |

**Note:** All preconfigured models are standard with two columns of 11" wide shelves and the remaining columns with 12" wide shelves. You may receive extra shelves with sorters.

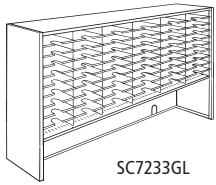

SC7233GL

| Parent # | Description  | Model #  | List Price Ea. | List Carton Price | Number of Cartons | Actual Weight | S-Parcel Billable Weight | Carton Cube | Freight Class |
|----------|--|----------|----------------|-------------------|-------------------|---------------|--------------------------|-------------|---------------|
|          | <b>SC7233</b> Mailflow System® Elevated 9"H Closed-Back Sorter<br>Shelf Capacity: 42<br>2 columns of 11"W & 4 column 12"W Shelves<br>Size: 72"W x 15"D x 33"H<br>Size (Inside): 70"W x 15"D x 21"H<br>42 Sorting Pockets 15"D without Plexi Doors - GL | SC7233GL | 4,724.00       | 4,724.00          | 1                 | 237           | -                        | -           | -             |
|          | <b>SC7241</b> Mailflow System® Elevated 8"H Closed-Back Sorter<br>Shelf Capacity: 60<br>2 columns of 11"W & 4 column 12"W Shelves<br>Size: 72"W x 15"D x 41"H<br>Size (Inside): 70"W x 15"D x 30"H<br>60 Sorting Pockets 15"D without Plexi Doors - GL | SC7241GL | 6,197.00       | 6,197.00          | 1                 | 292           | -                        | -           | -             |
|          | Mailflow System® Elevated 17"H Closed-Back Sorter<br>Shelf Capacity: 42<br>2 columns of 11"W & 4 column 12"W Shelves<br>Size: 72"W x 15"D x 41"H<br>Size (Inside): 70"W x 15"D x 21"H<br>42 Sorting Pockets 15"D without Plexi Doors - GH              | SC7241GH | 5,205.00       | 5,205.00          | 1                 | 245           | -                        | -           | -             |
|          | <b>SC7248</b> Mailflow System® Elevated 7"H Closed-Back Sorter<br>Shelf Capacity: 72<br>2 columns of 11"W & 4 column 12"W Shelves<br>Size: 72"W x 15"D x 48"H<br>Size (Inside): 70"W x 15"D x 38"H<br>72 Sorting Pockets 15"D without Plexi Doors - GL | SC7248GL | 6,676.00       | 6,676.00          | 1                 | 332           | -                        | -           | -             |
|          | Mailflow System® Elevated 15"H Closed-Back Sorter<br>Shelf Capacity: 60<br>2 columns of 11"W & 4 column 12"W Shelves<br>Size: 72"W x 15"D x 48"H<br>Size (Inside): 70"W x 15"D x 30"H<br>60 Sorting Pockets 15"D without Plexi Doors - GH              | SC7248GH | 6,416.00       | 6,416.00          | 1                 | 300           | -                        | -           | -             |

**Note:** All preconfigured models are standard with two columns of 11" wide shelves and the remaining columns with 12" wide shelves. You may receive extra shelves with sorters.

**Open-Back Sorters**

Open-Back Sorters are typically used where mail is passed through – sorted on one side and collected by the recipient on the other.

- All sorters are 15" deep with 14" deep sorting shelves. Adjust on 1/2"H increments
- Preconfigured models, designated by the letter "C" are available, or build-your-own and adding components on pages 158-164.
- Pricing below is for sorters without doors
- Available in Safco® Corporate Colors see page 7 or go to [Safcoproducts.com](http://Safcoproducts.com) for more information

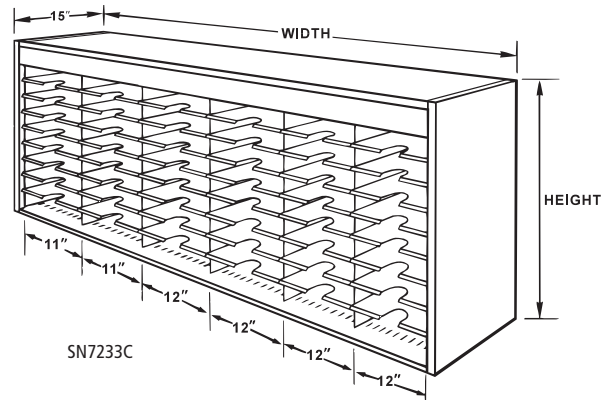

For assistance with custom Mailflow Systems configuration contact your local Safco Sales Rep Group.

| Parent #  | Description   | Model # | List Price Ea. | List Carton Price | Quantity Per Carton | Actual Weight | S-Parcel Billable Weight | Carton Cube | Freight Class |
|---|---|---------|----------------|-------------------|---------------------|---------------|--------------------------|-------------|---------------|
| <br>SN4833C | <b>SN4833</b> Mailflow System® Open-Back Sorter<br>Shelf Capacity: 36<br>2 columns of 11" W & 2 column 12" W Shelves<br>Size: 48" W x 15" D x 33" H<br>Size (Inside): 46" W x 15" D x 27" H<br>36 Sorting Pockets 15" D without Plexi Doors - C | SN4833C | 3,789.00       | 3,789.00          | 1                   | 149           | -                        | -           | -             |
|   | <b>SN4841</b> Mailflow System® Open-Back Sorter<br>Shelf Capacity: 44<br>2 columns of 11" W & 2 column 12" W Shelves<br>Size: 48" W x 15" D x 41" H<br>Size (Inside): 49" W x 15" D x 35" H<br>44 Sorting Pockets 15" D without Plexi Doors - C | SN4841C | 4,407.00       | 4,407.00          | 1                   | 181           | -                        | -           | -             |
|   | <b>SN4848</b> Mailflow System® Open-Back Sorter<br>Shelf Capacity: 56<br>2 columns of 11" W & 2 column 12" W Shelves<br>Size: 48" W x 15" D x 48" H<br>Size (Inside): 46" W x 15" D x 42" H<br>56 Sorting Pockets 15" D without Plexi Doors - C | SN4848C | 5,161.00       | 5,161.00          | 1                   | 213           | -                        | -           | -             |

**Note:** All preconfigured models are standard with two columns of 11" wide shelves and the remaining columns with 12" wide shelves. You may receive extra shelves with sorters.

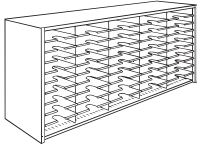
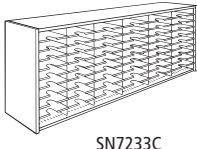
| Parent #   | Description   | Model # | List Price Ea. | List Carton Price | Quantity Per Carton | Actual Weight | S-Parcel Billable Weight | Carton Cube | Freight Class |
|--|---|---------|----------------|-------------------|---------------------|---------------|--------------------------|-------------|---------------|
|  <p>SN6033C</p> | <b>SN6033</b> Mailflow System® Open-Back Sorter<br>Shelf Capacity: 45<br>2 columns of 11"W & 3 column 12"W Shelves<br>Size: 60"W x 15"D x 33"H<br>Size (Inside): 58"W x 15"D x 27"H<br>45 Sorting Pockets 15"D without Plexi Doors- C | SN6033C | 4,474.00       | 4,474.00          | 1                   | 188           | -                        | -           | -             |
|  | <b>SN6041</b> Mailflow System® Open-Back Sorter<br>Shelf Capacity: 55<br>2 columns of 11"W & 3 column 12"W Shelves<br>Size: 60"W x 15"D x 41"H<br>Size (Inside): 58"W x 15"D x 35"H<br>55 Sorting Pockets 15"D without Plexi Doors- C | SN6041C | 5,031.00       | 5,031.00          | 1                   | 238           | -                        | -           | -             |
|  | <b>SN6048</b> Mailflow System® Open-Back Sorter<br>Shelf Capacity: 70<br>2 columns of 11"W & 3 column 12"W Shelves<br>Size: 60"W x 15"D x 48"H<br>Size (Inside): 58"W x 15"D x 42"H<br>70 Sorting Pockets 15"D without Plexi Doors- C | SN6048C | 6,152.00       | 6,152.00          | 1                   | 285           | -                        | -           | -             |
|  | <b>SN7233</b> Mailflow System® Open-Back Sorter<br>Shelf Capacity: 54<br>2 columns of 11"W & 4 column 12"W Shelves<br>Size: 72"W x 15"D x 33"H<br>Size (Inside): 70"W x 15"D x 27"H<br>54 Sorting Pockets 15"D without Plexi Doors- C | SN7233C | 5,017.00       | 5,017.00          | 1                   | 232           | -                        | -           | -             |
|  | <b>SN7241</b> Mailflow System® Open-Back Sorter<br>Shelf Capacity: 66<br>2 columns of 11"W & 4 column 12"W Shelves<br>Size: 72"W x 15"D x 41"H<br>Size (Inside): 70"W x 15"D x 35"H<br>66 Sorting Pockets 15"D without Plexi Doors- C | SN7241C | 5,907.00       | 5,907.00          | 1                   | 282           | -                        | -           | -             |
|  <p>SN7233C</p> | <b>SN7248</b> Mailflow System® Open-Back Sorter<br>Shelf Capacity: 84<br>2 columns of 11"W & 4 column 12"W Shelves<br>Size: 72"W x 15"D x 48"H<br>Size (Inside): 70"W x 15"D x 42"H<br>84 Sorting Pockets 15"D without Plexi Doors- C | SN7248C | 7,062.00       | 7,062.00          | 1                   | 331           | -                        | -           | -             |

**Note:** All preconfigured models are standard with two columns of 11" wide shelves and the remaining columns with 12" wide shelves. You may receive extra shelves with sorters.

**Elevated Open-Back Sorters**

Open-Back Sorters are typically used where mail is passed through – sorted on one side and collected by the recipient on the other

- All sorters are 15" deep with 14" deep sorting shelves. Adjust on 1/2"H increments
- Preconfigured models, designated by the letter "C" are available, or build-your-own and adding components on pages 158-164
- Elevated sorters offer more workspace, by raising the sorter off the work area
- Pricing below is for sorters without doors
- Available in Safco® Corporate Colors see page 7 or go to [Safcoproducts.com](http://Safcoproducts.com) for more information

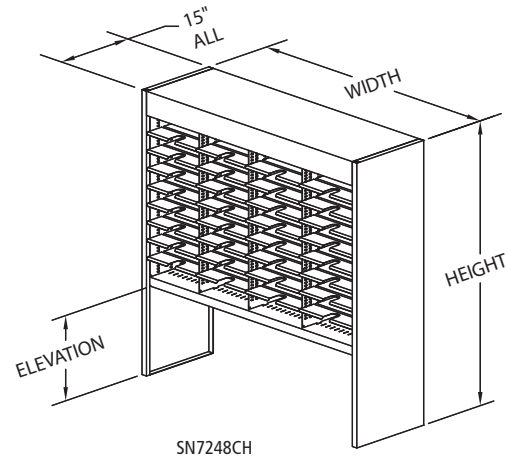

For assistance with custom Mailflow Systems configuration contact your local Safco Sales Rep Group.

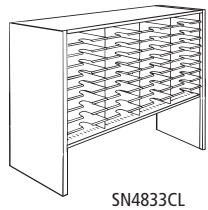

SN4833CL

| Parent #      | Description   | Model #  | List Price Ea. | List Carton Price | Quantity Per Carton | Actual Weight | S-Parcel Billable Weight | Carton Cube | Freight Class |
|---------------|---|----------|----------------|-------------------|---------------------|---------------|--------------------------|-------------|---------------|
| <b>SN4833</b> | Mailflow System® Elevated 9" H Open-Back Sorter<br>Shelf Capacity: 24<br>2 columns of 11"W & 2 column 12"W Shelves<br>Size: 48"W x 15"D x 33"H<br>Size (Inside): 46"W x 15"D x 18"H<br>24 Sorting Pockets 15"D without Plexi Doors- CL  | SN4833CL | 3,346.00       | 3,346.00          | 1                   | 103           | -                        | -           | -             |
| <b>SN4841</b> | Mailflow System® Elevated 8" H Open-Back Sorter<br>Shelf Capacity: 36<br>2 columns of 11"W & 2 column 12"W Shelves<br>Size: 48"W x 15"D x 41"H<br>Size (Inside): 46"W x 15"D x 27"H<br>36 Sorting Pockets 15"D without Plexi Doors- CL  | SN4841CL | 4,037.00       | 4,037.00          | 1                   | 132           | -                        | -           | -             |
|               | Mailflow System® Elevated 17" H Open-Back Sorter<br>Shelf Capacity: 24<br>2 columns of 11"W & 2 column 12"W Shelves<br>Size: 48"W x 15"D x 41"H<br>Size (Inside): 46"W x 15"D x 18"H<br>24 Sorting Pockets 15"D without Plexi Doors- CH | SN4841CH | 3,781.00       | 3,781.00          | 1                   | 108           | -                        | -           | -             |
| <b>SN4848</b> | Mailflow System® Elevated 7" H Open-Back Sorter<br>Shelf Capacity: 44<br>2 columns of 11"W & 2 column 12"W Shelves<br>Size: 48"W x 15"D x 48"H<br>Size (Inside): 46"W x 15"D x 35"H<br>44 Sorting Pockets 15"D without Plexi Doors- C   | SN4848CL | 4,843.00       | 4,843.00          | 1                   | 153           | -                        | -           | -             |
|               | Mailflow System® Elevated 15" H Open-Back Sorter<br>Shelf Capacity: 36<br>2 columns of 11"W & 2 column 12"W Shelves<br>Size: 48"W x 15"D x 48"H<br>Size (Inside): 46"W x 15"D x 27"H<br>36 Sorting Pockets 15"D without Plexi Doors- CH | SN4848CH | 4,328.00       | 4,328.00          | 1                   | 137           | -                        | -           | -             |

**Note:** All preconfigured models are standard with two columns of 11" wide shelves and the remaining columns with 12" wide shelves. You may receive extra shelves with sorters.

| Parent # | Description   | Model #  | List Price Ea. | List Carton Price | Quantity Per Carton | Actual Weight | S-Parcel Billable Weight | Carton Cube | Freight Class |
|----------|---|----------|----------------|-------------------|---------------------|---------------|--------------------------|-------------|---------------|
| SN6033CL | <b>SN6033</b> Mailflow System® Elevated 9"H Open-Back Sorter<br>Shelf Capacity: 30<br>2 columns of 11"W & 3 column 12"W Shelves<br>Size: 60"W x 15"D x 33"H<br>Size (Inside): 58"W x 15"D x 18"H<br>30 Sorting Pockets 15"D without Plexi Doors- CL | SN6033CL | 3,802.00       | 3,802.00          | 1                   | 135           | -                        | -           | -             |
|          | <b>SN6041</b> Mailflow System® Elevated 8"H Open-Back Sorter<br>Shelf Capacity: 45<br>2 columns of 11"W & 3 column 12"W Shelves<br>Size: 60"W x 15"D x 41"H<br>Size (Inside): 58"W x 15"D x 27"H<br>45 Sorting Pockets 15"D without Plexi Doors- CL | SN6041CL | 4,743.00       | 4,743.00          | 1                   | 170           | -                        | -           | -             |
|          | Mailflow System® Elevated 17"H Open-Back Sorter<br>Shelf Capacity: 30<br>2 columns of 11"W & 3 column 12"W Shelves<br>Size: 60"W x 15"D x 41"H<br>Size (Inside): 58"W x 15"D x 18"H<br>30 Sorting Pockets 15"D without Plexi Doors- CH              | SN6041CH | 4,254.00       | 4,254.00          | 1                   | 140           | -                        | -           | -             |
| SN6048CL | <b>SN6048</b> Mailflow System® Elevated 7"H Open-Back Sorter<br>Shelf Capacity: 55<br>2 columns of 11"W & 3 column 12"W Shelves<br>Size: 60"W x 15"D x 48"H<br>Size (Inside): 58"W x 15"D x 35"H<br>55 Sorting Pockets 15"D without Plexi Doors- CL | SN6048CL | 5,205.00       | 5,205.00          | 1                   | 195           | -                        | -           | -             |
|          | Mailflow System® Elevated 15"H Open-Back Sorter<br>Shelf Capacity: 45<br>2 columns of 11"W & 3 column 12"W Shelves<br>Size: 60"W x 15"D x 48"H<br>Size (Inside): 58"W x 15"D x 27"H<br>45 Sorting Pockets 15"D without Plexi Doors- CH              | SN6048CH | 5,286.00       | 5,286.00          | 1                   | 175           | -                        | -           | -             |
| SN7233CL | <b>SN7233</b> Mailflow System® Elevated 9"H Open-Back Sorter<br>Shelf Capacity: 36<br>2 columns of 11"W & 4 column 12"W Shelves<br>Size: 72"W x 15"D x 33"H<br>Size (Inside): 70"W x 15"D x 18"H<br>36 Sorting Pockets 15"D without Plexi Doors- CL | SN7233CL | 4,489.00       | 4,489.00          | 1                   | 164           | -                        | -           | -             |
|          | <b>SN7241</b> Mailflow System® Elevated 8"H Open-Back Sorter<br>Shelf Capacity: 54<br>2 columns of 11"W & 4 column 12"W Shelves<br>Size: 72"W x 15"D x 41"H<br>Size (Inside): 70"W x 15"D x 27"H<br>54 Sorting Pockets 15"D without Plexi Doors- CL | SN7241CL | 5,594.00       | 5,594.00          | 1                   | 213           | -                        | -           | -             |
|          | Mailflow System® Elevated 17"H Open-Back Sorter<br>Shelf Capacity: 36<br>2 columns of 11"W & 4 column 12"W Shelves<br>Size: 72"W x 15"D x 41"H<br>Size (Inside): 70"W x 15"D x 18"H<br>36 Sorting Pockets 15"D without Plexi Doors- CH              | SN7241CH | 5,059.00       | 5,059.00          | 1                   | 177           | -                        | -           | -             |
| SN7248CL | <b>SN7248</b> Mailflow System® Elevated 7"H Open-Back Sorter<br>Shelf Capacity: 66<br>2 columns of 11"W & 4 column 12"W Shelves<br>Size: 72"W x 15"D x 48"H<br>Size (Inside): 70"W x 15"D x 35"H<br>66 Sorting Pockets 15"D without Plexi Doors- CL | SN7248CL | 5,976.00       | 5,976.00          | 1                   | 247           | -                        | -           | -             |
|          | Mailflow System® Elevated 15"H Open-Back Sorter<br>Shelf Capacity: 54<br>2 columns of 11"W & 4 column 12"W Shelves<br>Size: 72"W x 15"D x 48"H<br>Size (Inside): 70"W x 15"D x 27"H<br>54 Sorting Pockets 15"D without Plexi Doors- CH              | SN7248CH | 5,753.00       | 5,753.00          | 1                   | 223           | -                        | -           | -             |

**Note:** All preconfigured models are standard with two columns of 11" wide shelves and the remaining columns with 12" wide shelves. You may receive extra shelves with sorters.

**Work Surface Finishes – High Pressure Laminate**

|                  |              |
|------------------|--------------|
| Designer White   | Fusion Maple |
| Biltmore Cherry  | Black        |
| Columbian Walnut | Asian Night  |
| Fashion Gray     | Asian Sand   |

**High-Pressure Laminate Edge Band Colors**

|                |
|----------------|
| Designer White |
| Black          |
| Ice Gray       |

**Safco® Corporate Color Program – Powder Coat Paint Finishes**

|             |             |                   |
|-------------|-------------|-------------------|
| Black       | Navy        | Textured Graphite |
| Blue Medium | Tech Silver | Textured Gray     |
| Desert Sage | White       | Textured Black    |
| Mist        |             |                   |

**Custom Request Form see page 8**

All requests for customization of product, sizes and finishes must have prior approval. Please email [specials@safcoproducts.com](mailto:specials@safcoproducts.com)

Contact your local Safco Sales Rep Group to discuss space planning specific application, obtain prior approval and quote.

**TO ORDER, PLEASE SPECIFY:**

Example: **S A 3 6 8 0 G 1** + **B L A C K** + **B L A C K** + **D E S E R T S A G E**  
MODEL HIGH PRESSURE LAMINATE COLOR EDGE BAND COLOR CABINET POWDER COAT FINISH  
WHEN ORDERING HIGH PRESSURE LAMINATE ADD SUFFIX "LAM"

| Parent # | Description | Model # | List Price Ea. | List Carton Price | Quantity Per Carton | Actual Weight | S-Parcel Billable Weight | Carton Cube | Freight Class |
|----------|-------------|---------|----------------|-------------------|---------------------|---------------|--------------------------|-------------|---------------|
|----------|-------------|---------|----------------|-------------------|---------------------|---------------|--------------------------|-------------|---------------|

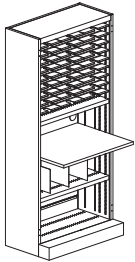

- Steel back panel has one 3" diameter cable management cutout
- Shelves and work surface adjust on 1/2" H increments
- All-welded steel cabinet construction

**Satellite Sorter - 36"W x 80"H x 16"D**

|                 |   |             |          |          |   |     |   |   |   |
|-----------------|---|-------------|----------|----------|---|-----|---|---|---|
| <b>SA3680G1</b> | Satellite Sorter, Shelf: 15"D, 30 Pocket<br>2 columns of 11"W & 1 column 12"W Shelves<br>Work Surface: 33½"W x 27"D x 1"H | SA3680G1LAM | 6,340.00 | 6,340.00 | 1 | 240 | – | – | – |
| <b>SA3680L1</b> | Satellite Sorter, Shelf: 12"D, 30 Pocket<br>2 columns of 11"W & 1 column 12"W Shelves<br>Work Surface: 33½"W x 27"D x 1"H | SA3680L1LAM | 5,999.00 | 5,999.00 | 1 | 222 | – | – | – |

**Specialized Freestanding Sorters**

- Preconfigured models come standard with 3"H pockets in either letter (12"D) or legal (15"D) depths. Adjust on 1/2" H increments
- All-welded steel cabinet construction

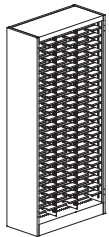

**Specialized Freestanding Sorters - 36"W, 2 columns of 11"W & 1 column 12"W Shelves**

|                |   |                        |                      |                      |        |            |        |        |        |
|----------------|---|------------------------|----------------------|----------------------|--------|------------|--------|--------|--------|
| <b>SF3665B</b> | Mailflow System® Freestanding Sorter<br>Shelf Capacity: 57<br>Size: 36"W x 12"D x 64½"H - Letter-Size - BL1<br>Size: 36"W x 15"D x 64½"H - Legal-Size - BG1 | SF3665BL1<br>SF3665BG1 | 5,540.00<br>6,108.00 | 5,540.00<br>6,108.00 | 1<br>1 | 292<br>273 | –<br>– | –<br>– | –<br>– |
| <b>SF3680B</b> | Mailflow System® Freestanding Sorter<br>Shelf Capacity: 72<br>Size: 36"W x 12"D x 80"H - Letter-Size - BL1<br>Size: 36"W x 15"D x 80"H - Legal-Size - BG1   | SF3680BL1<br>SF3680BG1 | 6,485.00<br>7,010.00 | 6,485.00<br>7,010.00 | 1<br>1 | 414<br>444 | –<br>– | –<br>– | –<br>– |
| <b>SF3665D</b> | Mailflow System® Freestanding Sorter<br>Shelf Capacity: 45<br>Size: 36"W x 12"D x 64½"H - Letter-Size-DL1<br>Size: 36"W x 15"D x 64½"H - Legal-Size-DG1     | SF3665DL1<br>SF3665DG1 | 5,158.00<br>5,627.00 | 5,158.00<br>5,627.00 | 1<br>1 | 292<br>273 | –<br>– | –<br>– | –<br>– |
| <b>SF3680D</b> | Mailflow System® Freestanding Sorter<br>Shelf Capacity: 57<br>Size: 36"W x 12"D x 80"H - Letter-Size - DL1<br>Size: 36"W x 15"D x 80"H - Legal-Size - DG1   | SF3680DL1<br>SF3680DG1 | 6,136.00<br>6,556.00 | 6,136.00<br>6,556.00 | 1<br>1 | 414<br>444 | –<br>– | –<br>– | –<br>– |

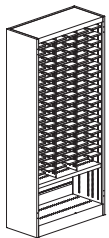

- All shelves lock in place and won't pull out when retrieving mail
- Shelves can be removed for easy height adjustment on 1/2" increments
- Shelves have centered thumb cut for quick, one-handed retrieval
- Heavy-duty, 20-gauge shelves with V-groove hold up to 75 lbs. per pocket

- Front edge of shelves has a 45° beveled labeling flange for easy reading of labels and allows mail from pocket below to pass under above shelf without hanging up

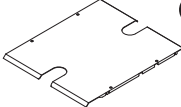
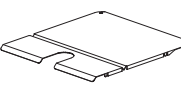
| Parent #  | Description  | Model #  | List Price Ea. | List Carton Price | Quantity Per Carton | Actual Weight | S-Parcel Billable Weight | Carton Cube | Freight Class |   |
|---|--|--|----------------|-------------------|---------------------|---------------|--------------------------|-------------|---------------|---|
|  | <b>GSA Kwik-Shelf™ Shelving System for Open-Back Sorters, Plexi Door Units</b> |  |                |                   |                     |               |                          |             |               |   |
|   | <b>1114P06</b>   | Shelf for Open-Back Sorter<br>Shelf: 11"W x 14½"D  | 1114P06        | 260.00            | 260.00              | 6             | 2                        | -           | -             | - |
|   | <b>1214P06</b>   | Shelf for Open-Back Sorter<br>Shelf: 12"W x 14½"D  | 1214P06        | 264.00            | 264.00              | 6             | 2.5                      | -           | -             | - |
|  | <b>GSA Kwik-Shelf™ Shelving System for Non-Plexi Door, Closed-Back Sorters</b> |  |                |                   |                     |               |                          |             |               |   |
|   | <b>0412P06</b>   | Shelf for Closed-Back Sorter<br>Shelf: 4"W x 12"D  | 0412P06        | 142.00            | 142.00              | 6             | 0.5                      | -           | -             | - |
|   | <b>0512P06</b>   | Shelf for Closed-Back Sorter<br>Shelf: 5"W x 12"D  | 0512P06        | 152.00            | 152.00              | 6             | 0.75                     | -           | -             | - |
|   | <b>0515P06</b>   | Shelf for Closed-Back Sorter<br>Shelf: 5"W x 15"D  | 0515P06        | 158.00            | 158.00              | 6             | 1                        | -           | -             | - |
|   | <b>0612P06</b>   | Shelf for Closed-Back Sorter<br>Shelf: 6"W x 12"D  | 0612P06        | 157.00            | 157.00              | 6             | 0.75                     | -           | -             | - |
|   | <b>0712P06</b>   | Shelf for Closed-Back Sorter<br>Shelf: 7"W x 12"D  | 0712P06        | 165.00            | 165.00              | 6             | 1                        | -           | -             | - |
|   | <b>0812P06</b>   | Shelf for Closed-Back Sorter<br>Shelf: 8"W x 12"D  | 0812P06        | 195.00            | 195.00              | 6             | 1.05                     | -           | -             | - |
|   | <b>0912P06</b>   | Shelf for Closed-Back Sorter<br>Shelf: 9"W x 12"D  | 0912P06        | 214.00            | 214.00              | 6             | 1.05                     | -           | -             | - |
|   | <b>0915P06</b>   | Shelf for Closed-Back Sorter<br>Shelf: 9"W x 15"D  | 0915P06        | 243.00            | 243.00              | 6             | 2                        | -           | -             | - |
|   | <b>1012P06</b>   | Shelf for Closed-Back Sorter<br>Shelf: 10"W x 12"D | 1012P06        | 226.00            | 226.00              | 6             | 1.15                     | -           | -             | - |
|   | <b>1015P06</b>   | Shelf for Closed-Back Sorter<br>Shelf: 10"W x 15"D | 1015P06        | 259.00            | 259.00              | 6             | 1.5                      | -           | -             | - |
|   | <b>1112P06</b>   | Shelf for Closed-Back Sorter<br>Shelf: 11"W x 12"D | 1112P06        | 240.00            | 240.00              | 6             | 1.25                     | -           | -             | - |
|   | <b>1115P06</b>   | Shelf for Closed-Back Sorter<br>Shelf: 11"W x 15"D | 1115P06        | 260.00            | 260.00              | 6             | 1.75                     | -           | -             | - |
|   | <b>1212P06</b>   | Shelf for Closed-Back Sorter<br>Shelf: 12"W x 12"D | 1212P06        | 243.00            | 243.00              | 6             | 1.4                      | -           | -             | - |
|   | <b>1215P06</b>   | Shelf for Closed-Back Sorter<br>Shelf: 12"W x 15"D | 1215P06        | 272.00            | 272.00              | 6             | 1.75                     | -           | -             | - |
|   | <b>1412P06</b>   | Shelf for Closed-Back Sorter<br>Shelf: 14"W x 12"D | 1412P06        | 333.00            | 333.00              | 6             | 2.3                      | -           | -             | - |
|   | <b>1415P06</b>   | Shelf for Closed-Back Sorter<br>Shelf: 14"W x 15"D | 1415P06        | 360.00            | 360.00              | 6             | 2.75                     | -           | -             | - |
|   | <b>1515P06</b>   | Shelf for Closed-Back Sorter<br>Shelf: 15"W x 15"D | 1515P06        | 402.00            | 402.00              | 6             | 2.9                      | -           | -             | - |
| <b>1612P06</b>  | Shelf for Closed-Back Sorter<br>Shelf: 16"W x 12"D                             | 1612P06  | 384.00         | 384.00            | 6                   | 2.8           | -                        | -           | -             |   |
| <b>1615P06</b>  | Shelf for Closed-Back Sorter<br>Shelf: 16"W x 15"D                             | 1615P06  | 420.00         | 420.00            | 6                   | 3             | -                        | -           | -             |   |



Shelf Supports divide a sorter into columns and support the shelves within each column.

- Shelf supports are adjustable in 1" horizontal increments to fit various shelf widths
- Each support is slotted at 1/2" vertical increments for shelf adjustment
- Shelf support models are based on sorter type, height and shelf depth
- When ordering, remember that the two end shelf supports are included with each sorter

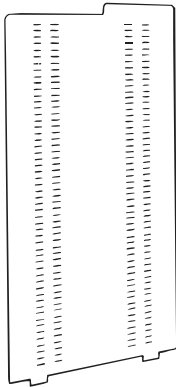

| Parent #                                       | Description  | Model #  | List Price Ea. | List Carton Price | Quantity Per Carton | Actual Weight | S-Parcel Billable Weight | Carton Cube | Freight Class |
|--|--|----------|----------------|-------------------|---------------------|---------------|--------------------------|-------------|---------------|
| <b>GSA Shelf Support - Closed-Back Sorters</b> |  |          |                |                   |                     |               |                          |             |               |
|  | <b>SS24LM0</b> Shelf Support - 21"H<br>Size: 12"W x 21"H | SS24LM01 | 83.00          | 83.00             | 1 Unit              | 5.4           | -                        | -           | -             |
|  |  | SS24LM02 | 163.00         | 163.00            | 2 Unit              | 5.4           | -                        | -           | -             |
|  |  | SS24LM03 | 248.00         | 248.00            | 3 Unit              | 5.4           | -                        | -           | -             |
|  |  | SS24LM04 | 327.00         | 327.00            | 4 Unit              | 5.4           | -                        | -           | -             |
|  |  | SS24LM05 | 415.00         | 415.00            | 5 Unit              | 5.4           | -                        | -           | -             |
|  | <b>SS24GM0</b> Shelf Support - 21"H<br>Size: 15"W x 21"H | SS24GM01 | 101.00         | 101.00            | 1 Unit              | 8.4           | -                        | -           | -             |
|  |  | SS24GM02 | 198.00         | 198.00            | 2 Unit              | 8.4           | -                        | -           | -             |
|  |  | SS24GM03 | 304.00         | 304.00            | 3 Unit              | 8.4           | -                        | -           | -             |
|  |  | SS24GM04 | 412.00         | 412.00            | 4 Unit              | 8.4           | -                        | -           | -             |
|  |  | SS24GM05 | 508.00         | 508.00            | 5 Unit              | 8.4           | -                        | -           | -             |
|  | <b>SS33LM0</b> Shelf Support - 30"H<br>Size: 12"W x 30"H | SS33LM01 | 93.00          | 93.00             | 1 Unit              | 8.0           | -                        | -           | -             |
|  |  | SS33LM02 | 193.00         | 193.00            | 2 Unit              | 8.0           | -                        | -           | -             |
|  |  | SS33LM03 | 297.00         | 297.00            | 3 Unit              | 8.0           | -                        | -           | -             |
|  |  | SS33LM04 | 401.00         | 401.00            | 4 Unit              | 8.0           | -                        | -           | -             |
|  |  | SS33LM05 | 490.00         | 490.00            | 5 Unit              | 8.0           | -                        | -           | -             |
|  | <b>SS33GM0</b> Shelf Support - 30"H<br>Size: 15"W x 30"H | SS33GM01 | 119.00         | 119.00            | 1 Unit              | 10.5          | -                        | -           | -             |
|  |  | SS33GM02 | 240.00         | 240.00            | 2 Unit              | 10.5          | -                        | -           | -             |
|  |  | SS33GM03 | 347.00         | 347.00            | 3 Unit              | 10.5          | -                        | -           | -             |
|  |  | SS33GM04 | 464.00         | 464.00            | 4 Unit              | 10.5          | -                        | -           | -             |
|  |  | SS33GM05 | 571.00         | 571.00            | 5 Unit              | 10.5          | -                        | -           | -             |
|  | <b>SS41LM0</b> Shelf Support - 38"H<br>Size: 12"W x 38"H | SS41LM01 | 115.00         | 115.00            | 1 Unit              | 9.5           | -                        | -           | -             |
|  |  | SS41LM02 | 234.00         | 234.00            | 2 Unit              | 9.5           | -                        | -           | -             |
|  |  | SS41LM03 | 347.00         | 347.00            | 3 Unit              | 9.5           | -                        | -           | -             |
|  |  | SS41LM04 | 478.00         | 478.00            | 4 Unit              | 9.5           | -                        | -           | -             |
|  |  | SS41LM05 | 589.00         | 589.00            | 5 Unit              | 9.5           | -                        | -           | -             |
|  | <b>SS41GM0</b> Shelf Support - 38"H<br>Size: 15"W x 38"H | SS41GM01 | 134.00         | 134.00            | 1 Unit              | 12.6          | -                        | -           | -             |
|  |  | SS41GM02 | 276.00         | 276.00            | 2 Unit              | 12.6          | -                        | -           | -             |
|  |  | SS41GM03 | 403.00         | 403.00            | 3 Unit              | 12.6          | -                        | -           | -             |
|  |  | SS41GM04 | 549.00         | 549.00            | 4 Unit              | 12.6          | -                        | -           | -             |
|  |  | SS41GM05 | 692.00         | 692.00            | 5 Unit              | 12.6          | -                        | -           | -             |
|  | <b>SS48LM0</b> Shelf Support - 45"H<br>Size: 12"W x 45"H | SS48LM01 | 134.00         | 134.00            | 1 Unit              | 11.0          | -                        | -           | -             |
|  |  | SS48LM02 | 285.00         | 285.00            | 2 Unit              | 11.0          | -                        | -           | -             |
|  |  | SS48LM03 | 415.00         | 415.00            | 3 Unit              | 11.0          | -                        | -           | -             |
|  |  | SS48LM04 | 532.00         | 532.00            | 4 Unit              | 11.0          | -                        | -           | -             |
|  |  | SS48LM05 | 692.00         | 692.00            | 5 Unit              | 11.0          | -                        | -           | -             |
|  | <b>SS48GM0</b> Shelf Support - 45"H<br>Size: 15"W x 45"H | SS48GM01 | 162.00         | 162.00            | 1 Unit              | 14.8          | -                        | -           | -             |
|  |  | SS48GM02 | 307.00         | 307.00            | 2 Unit              | 14.8          | -                        | -           | -             |
|  |  | SS48GM03 | 478.00         | 478.00            | 3 Unit              | 14.8          | -                        | -           | -             |
|  |  | SS48GM04 | 631.00         | 631.00            | 4 Unit              | 14.8          | -                        | -           | -             |
|  |  | SS48GM05 | 786.00         | 786.00            | 5 Unit              | 14.8          | -                        | -           | -             |

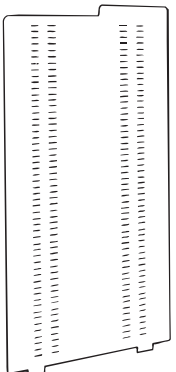

|   |  |         |        |        |        |      |   |   |   |
|---|--|---------|--------|--------|--------|------|---|---|---|
| <b>GSA Shelf Support - Open-Back and Plexi Back Sorters</b> |  |         |        |        |        |      |   |   |   |
|   | <b>SS24N0</b> Shelf Support - 21"H<br>Size: 14 1/2" D x 21"H | SS24N01 | 98.00  | 98.00  | 1 Unit | 8.0  | - | - | - |
|   |  | SS24N02 | 204.00 | 204.00 | 2 Unit | 8.0  | - | - | - |
|   |  | SS24N03 | 304.00 | 304.00 | 3 Unit | 8.0  | - | - | - |
|   |  | SS24N04 | 412.00 | 412.00 | 4 Unit | 8.0  | - | - | - |
|   |  | SS24N05 | 508.00 | 508.00 | 5 Unit | 8.0  | - | - | - |
|   | <b>SS33N0</b> Shelf Support - 30"H<br>Size: 14 1/2" D x 30"H | SS33N01 | 115.00 | 115.00 | 1 Unit | 10.0 | - | - | - |
|   |  | SS33N02 | 240.00 | 240.00 | 2 Unit | 10.0 | - | - | - |
|   |  | SS33N03 | 347.00 | 347.00 | 3 Unit | 10.0 | - | - | - |
|   |  | SS33N04 | 478.00 | 478.00 | 4 Unit | 10.0 | - | - | - |
|   |  | SS33N05 | 589.00 | 589.00 | 5 Unit | 10.0 | - | - | - |
|   | <b>SS41N0</b> Shelf Support - 38"H<br>Size: 14 1/2" D x 38"H | SS41N01 | 134.00 | 134.00 | 1 Unit | 12.0 | - | - | - |
|   |  | SS41N02 | 285.00 | 285.00 | 2 Unit | 12.0 | - | - | - |
|   |  | SS41N03 | 415.00 | 415.00 | 3 Unit | 12.0 | - | - | - |
|   |  | SS41N04 | 549.00 | 549.00 | 4 Unit | 12.0 | - | - | - |
|   |  | SS41N05 | 692.00 | 692.00 | 5 Unit | 12.0 | - | - | - |
|   | <b>SS48N0</b> Shelf Support - 45"H<br>Size: 14 1/2" D x 45"H | SS48N01 | 163.00 | 163.00 | 1 Unit | 14.0 | - | - | - |
|   |  | SS48N02 | 332.00 | 332.00 | 2 Unit | 14.0 | - | - | - |
|   |  | SS48N03 | 478.00 | 478.00 | 3 Unit | 14.0 | - | - | - |
|   |  | SS48N04 | 649.00 | 649.00 | 4 Unit | 14.0 | - | - | - |
|   |  | SS48N05 | 811.00 | 811.00 | 5 Unit | 14.0 | - | - | - |

| Parent # | Description | Model # | List Price Ea. | List Carton Price | Quantity Per Carton | Actual Weight | S-Parcel Billable Weight | Carton Cube | Freight Class |
|----------|-------------|---------|----------------|-------------------|---------------------|---------------|--------------------------|-------------|---------------|
|----------|-------------|---------|----------------|-------------------|---------------------|---------------|--------------------------|-------------|---------------|

**Label Holders**

- Transparent label holders fit securely on beveled shelf front
- Blank, white label inserts with four sides are included

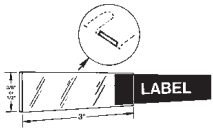

|        |                                      |        |       |   |    |       |   |   |   |
|--------|--------------------------------------|--------|-------|---|----|-------|---|---|---|
| 90145  | Label Holder, Adhesive - 3"W x 3/8"H | 90145  | 2.45  | — | 20 | 1 oz. | — | — | — |
| 911785 | Label Holder, Magnetic - 3"W x 1/2"H | 911785 | 3.65  | — | 20 | 3 oz. | — | — | — |
| 922VEL | Label Holder, Velcro® - 3"W x 1/2"H  | 922VEL | 80.00 | — | 20 | 3 oz. | — | — | — |

|        |   |        |       |   |        |       |   |   |   |
|--------|---|--------|-------|---|--------|-------|---|---|---|
| 90155  | Label, Adhesive - Colored - 3"W x 3/8"H | 90155  | 10.00 | — | 84/set | 1 oz. | — | — | — |
| 90154  | Label, Adhesive - White - 3"W x 3/8"H   | 90154  | 1.00  | — |        |       |   |   |   |
| 911884 | Label, Magnetic - White - 3"W x 1/2"H   | 911884 | 0.06  | — |        |       |   |   |   |

**90155 - Set of label inserts in six colors** (White, Orange, Blue, Yellow, Pink and Green), in microperforated, 8 1/2" x 11" sheets. 14 four-sided blank label inserts per color, 84 per set. Fit in label holders (above). Use with PC and ink jet or laser printer.

**Work Surface Finishes – High Pressure Laminate**

|                  |              |
|------------------|--------------|
| Designer White   | Fusion Maple |
| Biltmore Cherry  | Black        |
| Columbian Walnut | Asian Night  |
| Fashion Gray     | Asian Sand   |

**High-Pressure Laminate Edge Band Colors**

|                |       |          |
|----------------|-------|----------|
| Designer White | Black | Ice Gray |
|----------------|-------|----------|

**Safco® Corporate Color Program – Powder Coat Paint Finishes**

|             |             |                   |
|-------------|-------------|-------------------|
| Black       | Navy        | Textured Graphite |
| Blue Medium | Tech Silver | Textured Gray     |
| Desert Sage | White       | Textured Black    |
| Mist        |             |                   |

**Grommet**

For additional wire management select a grommet. Grommets are located towards the rear and positioned in the center of the table (Black only).

| <u>Model #</u> | <u>Suffix</u>             | <u>List Price</u> |
|----------------|---------------------------|-------------------|
| G              | Multi Use Grommet (Black) | 28.00             |

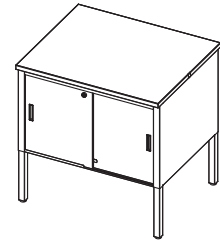

**Custom Request Form see page 8**

All requests for customization of product, sizes and finishes must have prior approval. Please email [specials@safcoproducts.com](mailto:specials@safcoproducts.com)

Contact your local Safco Sales Rep Group to discuss space planning specific application, obtain prior approval and quote.

**TO ORDER, PLEASE SPECIFY:**

Example: T S A 3 6 3 0 H G + B L A C K + B L A C K + T E C H S I L V E R  
MODEL LAMINATE FINISH EDGE BAND COLOR CABINET POWDER COAT FINISH

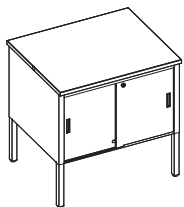

| Parent #  | Description   | Model #   | List Price Ea. | List Carton Price | Quantity Per Carton | Actual Weight | S-Parcel Billable Weight | Carton Cube | Freight Class |
|---|---|-----------|----------------|-------------------|---------------------|---------------|--------------------------|-------------|---------------|
| <b>Storage Tables - No Master Key Available</b> |   |           |                |                   |                     |               |                          |             |               |
| TSA3630H  | Storage Table<br>36"W x 30"D x 24" to 36"H                    | TSA3630H  | 3,239.00       | 3,239.00          | 1                   | 129           | -                        | -           | -             |
| TSA3630DH                                       | Storage Table with Locking Doors<br>36"W x 30"D x 24" to 36"H | TSA3630DH | 4,001.00       | 4,001.00          | 1                   | 146           | -                        | -           | -             |
| TSA4830H  | Storage Table<br>48"W x 30"D x 24" to 36"H                    | TSA4830H  | 3,540.00       | 3,540.00          | 1                   | 155           | -                        | -           | -             |
| TSA4830DH                                       | Storage Table with Locking Doors<br>48"W x 30"D x 24" to 36"H | TSA4830DH | 4,443.00       | 4,443.00          | 1                   | 172           | -                        | -           | -             |
| TSA6030H  | Storage Table<br>60"W x 30"D x 24" to 36"H                    | TSA6030H  | 3,983.00       | 3,983.00          | 1                   | 180           | -                        | -           | -             |
| TSA6030DH                                       | Storage Table with Locking Doors<br>60"W x 30"D x 24" to 36"H | TSA6030DH | 4,932.00       | 4,932.00          | 1                   | 198           | -                        | -           | -             |
| TSA7230H  | Storage Table<br>72"W x 30"D x 24" to 36"H                    | TSA7230H  | 4,453.00       | 4,453.00          | 1                   | 230           | -                        | -           | -             |
| TSA7230DH                                       | Storage Table with Locking Doors<br>72"W x 30"D x 24" to 36"H | TSA7230DH | 5,456.00       | 5,456.00          | 1                   | 250           | -                        | -           | -             |

| Parent #               | Description  | Model #               | List Price Ea. | List Carton Price | Quantity Per Carton | Actual Weight | S-Parcel Billable Weight | Carton Cube | Freight Class |
|------------------------|--|-----------------------|----------------|-------------------|---------------------|---------------|--------------------------|-------------|---------------|
| <b>GSA Work Tables</b> |  |                       |                |                   |                     |               |                          |             |               |
|                        | <b>TW30LAM</b> Work Table<br>30"W x 30"D x 24" to 36"H | High Pressure TW30LAM | 2,194.00       | 2,194.00          | 1                   | 66            | -                        | -           | -             |
|                        | <b>TW36LAM</b> Work Table<br>36"W x 30"D x 24" to 36"H | High Pressure TW36LAM | 2,602.00       | 2,602.00          | 1                   | 76            | -                        | -           | -             |
|                        | <b>TW48LAM</b> Work Table<br>48"W x 30"D x 24" to 36"H | High Pressure TW48LAM | 2,832.00       | 2,832.00          | 1                   | 94            | -                        | -           | -             |
|                        | <b>TW72LAM</b> Work Table<br>72"W x 30"D x 24" to 36"H | High Pressure TW72LAM | 3,693.00       | 3,693.00          | 1                   | 150           | -                        | -           | -             |

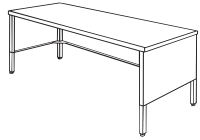

|                            |  |                       |          |          |   |     |   |   |   |
|----------------------------|--|-----------------------|----------|----------|---|-----|---|---|---|
| <b>GSA Pedestal Tables</b> |  |                       |          |          |   |     |   |   |   |
|                            | <b>TP48LAM</b> Pedestal Table<br>48"W x 30"D x 24" to 36"H                                   | High Pressure TP48LAM | 4,200.00 | 4,200.00 | 1 | 138 | - | - | - |
|                            | <b>TP60LAM</b> Pedestal Table<br>60"W x 30"D x 24" to 36"H                                   | High Pressure TP60LAM | 4,751.00 | 4,751.00 | 1 | 166 | - | - | - |
|                            | <b>TP72LAM</b> Pedestal Table<br>72"W x 30"D x 24" to 36"H                                   | High Pressure TP72LAM | 5,766.00 | 5,766.00 | 1 | 194 | - | - | - |
|                            | <b>APED1</b> Suspended Pedestal<br>1 Box and 1 File Drawer<br>15 1/4"W x 21 3/4"D x 19 3/8"H | APED1                 | 1,535.00 | 1,535.00 | 1 | 48  | - | - | - |

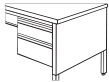
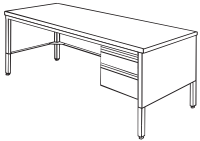

|                            |   |                       |          |          |   |    |   |   |   |
|----------------------------|---|-----------------------|----------|----------|---|----|---|---|---|
| <b>GSA Corner Platform</b> |   |                       |          |          |   |    |   |   |   |
|                            | <b>TCNRLAM</b> Corner Platform<br>30"W x 30"D x 24" to 36"H<br>(Fits in 32"W x 32"D Space)<br>Only can use on Work Tables | High Pressure TCNRLAM | 1,816.00 | 1,816.00 | 1 | 40 | - | - | - |

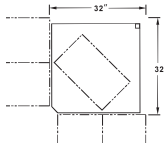

|   |  |                          |          |          |   |     |   |   |   |
|---|--|--------------------------|----------|----------|---|-----|---|---|---|
| <b>GSA Storage Consoles - No Master Key Available</b> |  |                          |          |          |   |     |   |   |   |
|   | <b>MC363030H</b> Storage Console<br>36"W x 30"D x 30"H                     | High Pressure MC363030H  | 3,349.00 | 3,349.00 | 1 | 126 | - | - | - |
|   | <b>MC363030DH</b> Storage Console with Locking Doors<br>36"W x 30"D x 30"H | High Pressure MC363030DH | 4,240.00 | 4,240.00 | 1 | 141 | - | - | - |
|   | <b>MC483030H</b> Storage Console<br>48"W x 30"D x 30"H                     | High Pressure MC483030H  | 3,827.00 | 3,827.00 | 1 | 155 | - | - | - |
|   | <b>MC483030DH</b> Storage Console with Locking Doors<br>48"W x 30"D x 30"H | High Pressure MC483030DH | 4,796.00 | 4,796.00 | 1 | 172 | - | - | - |
|   | <b>MC603030H</b> Storage Console<br>60"W x 30"D x 30"H                     | High Pressure MC603030H  | 3,951.00 | 3,951.00 | 1 | 184 | - | - | - |
|   | <b>MC603030DH</b> Storage Console with Locking Doors<br>60"W x 30"D x 30"H | High Pressure MC603030DH | 5,077.00 | 5,077.00 | 1 | 203 | - | - | - |
|   | <b>MC723030H</b> Storage Console<br>72"W x 30"D x 30"H                     | High Pressure MC723030H  | 4,407.00 | 4,407.00 | 1 | 213 | - | - | - |
|   | <b>MC723030DH</b> Storage Console with Locking Doors<br>72"W x 30"D x 30"H | High Pressure MC723030DH | 5,623.00 | 5,623.00 | 1 | 234 | - | - | - |

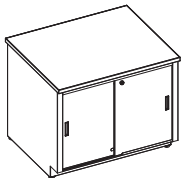

**Work Surface Finishes – High Pressure Laminate**

|                  |              |
|------------------|--------------|
| Designer White   | Fusion Maple |
| Biltmore Cherry  | Black        |
| Columbian Walnut | Asian Night  |
| Fashion Gray     | Asian Sand   |

**Grommet**

For additional wire management select a grommet. Grommets are located towards the rear and positioned in the center of the table (Black only).

| <u>Model #</u> | <u>Suffix</u>             | <u>List Price</u> |
|----------------|---------------------------|-------------------|
| G              | Multi Use Grommet (Black) | 28.00             |

**High-Pressure Laminate Edge Band Colors**

|                |       |          |
|----------------|-------|----------|
| Designer White | Black | Ice Gray |
|----------------|-------|----------|

**Safco® Corporate Color Program – Powder Coat Paint Finishes**

|             |             |                   |
|-------------|-------------|-------------------|
| Black       | Navy        | Textured Graphite |
| Blue Medium | Tech Silver | Textured Gray     |
| Desert Sage | White       | Textured Black    |
| Mist        |             |                   |

**Custom Request Form see page 8**

All requests for customization of product, sizes and finishes must have prior approval. Please email [specials@safcoproducts.com](mailto:specials@safcoproducts.com)

Contact your local Safco Sales Rep Group to discuss space planning specific application, obtain prior approval and quote.

**TO ORDER, PLEASE SPECIFY:**

Example: CL48TLAMG + BLACK + BLACK + TECH SILVER  
MODEL LAMINATE FINISH EDGE BAND COLOR CABINET POWDER COAT FINISH

WHEN ORDERING HIGH PRESSURE LAMINATE ADD SUFFIX "LAM"

| Parent # | Description | Model # | List Price Ea. | List Carton Price | Quantity Per Carton | Actual Weight | S-Parcel Billable Weight | Carton Cube | Freight Class |
|----------|-------------|---------|----------------|-------------------|---------------------|---------------|--------------------------|-------------|---------------|
|----------|-------------|---------|----------------|-------------------|---------------------|---------------|--------------------------|-------------|---------------|

**Adjustable Shelf Kits**



**Storage Table & Console Adjustable Shelf Kit**



|                |   |         |        |        |   |    |   |   |   |
|----------------|---|---------|--------|--------|---|----|---|---|---|
| <b>TSK3630</b> | Adjustable Shelf Kit, 32 $\frac{1}{2}$ "W x 24"D , Graphite | TSK3630 | 419.00 | 419.00 | 1 | 20 | - | - | - |
| <b>TSK4830</b> | Adjustable Shelf Kit, 44 $\frac{1}{2}$ "W x 24"D , Graphite | TSK4830 | 458.00 | 458.00 | 1 | 27 | - | - | - |
| <b>TSK6030</b> | Adjustable Shelf Kit, 56 $\frac{1}{2}$ "W x 24"D , Graphite | TSK6030 | 485.00 | 485.00 | 1 | 33 | - | - | - |
| <b>TSK7230</b> | Adjustable Shelf Kit, 68 $\frac{1}{2}$ "W x 24"D , Graphite | TSK7230 | 514.00 | 514.00 | 1 | 40 | - | - | - |

**Note:** 24"D shelf can only be used with the 30"D Storage Table and Sliding Door Console.

**Mailroom Table Accessories**



**Pencil Drawer** - Store pencils, other small objects. Mounts to any table without doors; field installed. Black only.

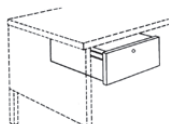

|             |   |      |        |        |   |   |   |   |   |
|-------------|---|------|--------|--------|---|---|---|---|---|
| <b>1218</b> | Pencil Drawer<br>24"W x 16"D x 1 $\frac{3}{4}$ "H | 1218 | 231.00 | 231.00 | 1 | 7 | - | - | - |
|-------------|---|------|--------|--------|---|---|---|---|---|

Build-your-own shipping system with individual frames, shelves, work surfaces and accessories.

- Frames are heavy-duty 11-gauge welded tubular steel
- Frames are slotted on 1" vertical increments allowing components to connect without tools
- Frames can be bolted together as your needs expand. 800 lbs. maximum load per frame
- Shelves are 14-gauge steel with welded attachment brackets
- Work surfaces are of 1" thick thermally-fused low-pressure laminate with medium density wood cores
- Standard finishes: Mist or Sand powder coat paint finish with Birch thermally-fused laminate work surface

| Parent # | Description | Model # | List Price Ea. | List Carton Price | Quantity Per Carton | Actual Weight | S-Parcel Billable Weight | Carton Cube | Freight Class |
|----------|-------------|---------|----------------|-------------------|---------------------|---------------|--------------------------|-------------|---------------|
|----------|-------------|---------|----------------|-------------------|---------------------|---------------|--------------------------|-------------|---------------|

**Build-Your-Own Shipping Workstation**

**GSA Steel Frames - 800 lbs. Maximum Load Per Frame**

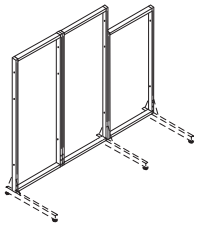

|         |                          |         |          |          |   |    |   |   |   |
|---------|--------------------------|---------|----------|----------|---|----|---|---|---|
| 3202460 | Steel Frame, 24"W x 60"H | 3202460 | 961.00   | 961.00   | 1 | 36 | - | - | - |
| 3202472 | Steel Frame, 24"W x 72"H | 3202472 | 1,031.00 | 1,031.00 | 1 | 40 | - | - | - |
| 3202484 | Steel Frame, 24"W x 84"H | 3202484 | 1,133.00 | 1,133.00 | 1 | 44 | - | - | - |
| 3203060 | Steel Frame, 30"W x 60"H | 3203060 | 990.00   | 990.00   | 1 | 39 | - | - | - |
| 3203072 | Steel Frame, 30"W x 72"H | 3203072 | 1,053.00 | 1,053.00 | 1 | 43 | - | - | - |
| 3203084 | Steel Frame, 30"W x 84"H | 3203084 | 1,158.00 | 1,158.00 | 1 | 48 | - | - | - |
| 3203660 | Steel Frame, 24"W x 60"H | 3203660 | 1,024.00 | 1,024.00 | 1 | 40 | - | - | - |
| 3203672 | Steel Frame, 24"W x 72"H | 3203672 | 1,071.00 | 1,071.00 | 1 | 47 | - | - | - |
| 3203684 | Steel Frame, 24"W x 84"H | 3203684 | 1,176.00 | 1,176.00 | 1 | 48 | - | - | - |

Standard finishes: Mist or Sand powder coat paint finish, please specify when ordering.

**GSA Leg Options**

350212



350213L



350214

|         |                                   |         |        |        |   |    |   |   |   |
|---------|-----------------------------------|---------|--------|--------|---|----|---|---|---|
| 350212  | Foot, Center Support              | 350212  | 146.00 | 146.00 | 1 | 2  | - | - | - |
| 350213R | Leg, Single Right                 | 350213R | 479.00 | 479.00 | 1 | 13 | - | - | - |
| 350213L | Leg, Single Left                  | 350213L | 479.00 | 479.00 | 1 | 13 | - | - | - |
| 350214  | Leg, Double-Sided (Universal)     | 350214  | 597.00 | 597.00 | 1 | 11 | - | - | - |
| 350215  | Casters for Frame (Pair; 1 Locks) | 350215  | 233.00 | 233.00 | 1 | 4  | - | - | - |

Standard finishes: Mist or Sand powder coat paint finish, please specify when ordering.

**GSA Horizontal Mounting Shelf, Steel (Includes Mounting Brackets)**

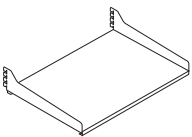

|         |                          |         |        |        |   |    |   |   |   |
|---------|--------------------------|---------|--------|--------|---|----|---|---|---|
| 3302416 | Steel Frame, 24"W x 16"D | 3302416 | 343.00 | 343.00 | 1 | 16 | - | - | - |
| 3303016 | Steel Frame, 30"W x 16"D | 3303016 | 418.00 | 418.00 | 1 | 19 | - | - | - |
| 3303616 | Steel Frame, 36"W x 16"D | 3303616 | 537.00 | 537.00 | 1 | 20 | - | - | - |
| 3304816 | Steel Frame, 48"W x 16"D | 3304816 | 780.00 | 780.00 | 1 | 27 | - | - | - |
| 3305416 | Steel Frame, 54"W x 16"D | 3305416 | 824.00 | 824.00 | 1 | 24 | - | - | - |
| 3306016 | Steel Frame, 60"W x 16"D | 3306016 | 873.00 | 873.00 | 1 | 32 | - | - | - |

Standard finishes: Mist or Sand powder coat paint finish, please specify when ordering.

**GSA Desk Worksurface (Includes Mounting Brackets)**

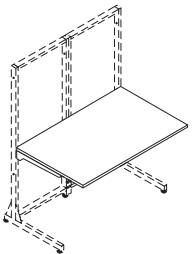

|         |                              |         |          |          |   |    |   |   |   |
|---------|------------------------------|---------|----------|----------|---|----|---|---|---|
| 3402430 | Work Surface, 24"W x 30"D    | 3402430 | 824.00   | 824.00   | 1 | 24 | - | - | - |
| 3403030 | Work Surface, 30"W x 30"D    | 3403030 | 934.00   | 934.00   | 1 | 30 | - | - | - |
| 3403630 | Work Surface, 36"W x 30"D    | 3403630 | 1,031.00 | 1,031.00 | 1 | 34 | - | - | - |
| 3404830 | Work Surface, 48"W x 30"D    | 3404830 | 1,233.00 | 1,233.00 | 1 | 45 | - | - | - |
| 3406030 | Work Surface, 60"W x 30"D    | 3406030 | 1,609.00 | 1,609.00 | 1 | 56 | - | - | - |
| 3407230 | Work Surface, 72"W x 30"D    | 3407230 | 1,752.00 | 1,752.00 | 1 | 78 | - | - | - |
| 3409030 | Work Surface, 90"W x 30"D    | 3409030 | 2,221.00 | 2,221.00 | 1 | 96 | - | - | - |
| 350220  | Adjustable Front Support Leg | 350220  | 310.00   | 310.00   | 1 | 4  | - | - | - |

Finish: Birch Thermally-Fused laminate work surface

**GSA Mailroom Accessories**

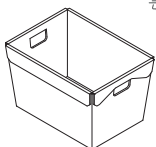

|              |  |       |        |        |   |   |   |   |   |
|--------------|--|-------|--------|--------|---|---|---|---|---|
| <b>Totes</b> |  |       |        |        |   |   |   |   |   |
| 90225        | Totes, Pack of 3<br>13 1/4"W x 18 1/4"D x 11 1/2"H | 90225 | 300.00 | 300.00 | 3 | 8 | - | - | - |

Totes of lightweight, high-density polyethylene with 3/8" dia. galvanized wire rod reinforcement at top. Available in packages of 3.